

PENCO®



[pencoproducts.com](http://pencoproducts.com)



# About Penco



The need for storage products is universal and Penco has grown a wide spectrum of solutions to fill that need. In doing so, Penco has become one of America's largest and most trusted suppliers of storage and work-area products. With state-of-the-art U.S. manufacturing facilities and QuickShip Distribution Centers strategically located throughout the United States and Canada, Penco is positioned to best serve your needs.

Market sectors served by Penco include educational, healthcare, and government facilities, as well as offices, manufacturing companies, distribution warehouses, retail outlets, sports arenas and community parks.

Shelving and pallet rack products are popular with warehousing and manufacturing applications, ranging from a few units to multi-level and high rise applications.

Lockers are widely used in educational facilities, fitness centers, healthcare, military, emergency response, commercial and industrial locations.



## Penco's 147 Year History

In 1869, a man named L. Lewis Sagendorph fulfilled his ambition to begin his own company that would produce the finest metal products in America. He called his fledgling business the Penn Metal Corporation of Pennsylvania, and began by making steel culvert pipe on Oregon Avenue in South Philadelphia.



Over the years, Penn Metal's product lines broadened to include lockers,

shelving and even aircraft landing mats. A reputation for quality fabrication spread, and the company's influence became nationwide. In the 1950's, the name was shortened to Penco Products and the plant and offices were expanded to a modern facility in Oaks, Pennsylvania, near Valley Forge.

In 2001, the manufacturing facilities were moved from Oaks to a 375,000 square foot manufacturing facility in Hamilton, North Carolina, allowing significant room for expansion. In 2013, the corporate headquarters was moved from Skippack, Pennsylvania to Greenville, North Carolina.



Headquarters in Greenville, NC

## LEEDS Environmental Information

- Based upon the most recent information from our source mills, the recycled content of our steel lockers can range from 25% to over 50%. Because the percentage of recycled content may vary from project to project based on a number of variables, please contact our offices for detailed information on your specific requirement.
- Powder coating drastically reduces waste through high efficiency application & recovery methods.
- Penco's powder coat paint contains no solvents and as a result releases no Volatile Organic Compounds (VOC's) normally associated with wet paint processes.
- Our packaging contains at least 20% post-consumer recycled content.
- Approximately 34% of the U.S. population lives within a 500 mile radius of our manufacturing facility, requiring less fuel to ship our products to many destinations.





## QuickShip Program 4 Strategic Locations

Visit [pencoproducts.com/quickship](http://pencoproducts.com/quickship) for a listing of which products are available at each warehouse location shown above.

- QuickShip Clipper Shelving** ..... 18
- QuickShip RivetRite Shelving**.....38-39
- QuickShip Barrier Rail**..... 50
- QuickShip Vanguard Lockers** .....68-69

Penco Products leads the industry with its comprehensive QuickShip program. Penco's QuickShip Distribution Centers have been strategically located throughout North America to best serve customer needs with prompt delivery of products from the shortest distance possible. Penco's QuickShip program saves time, delivery cost and energy, thus reducing the impact on our environment.



Chart of  
24 Designer Colors  
**See Page 87**

## Shelving

- Clipper Shelving..... 4
- QuickShip Clipper Shelving ..... 18
- Wide Span Shelving..... 20
- RivetRite Shelving ..... 25
- QuickShip RivetRite Shelving..... 38
- Ask for Penco's Erectomatic Shelving catalog

## Pallet Rack

- Pallet Rack ..... 42
- Channel-Lock Safety Grating ..... 48

## WorkSafe

- QuickShip/Standard Barrier Rail..... 50
- Guide Rail and Protectors ..... 52
- Bollards and Guards..... 53

## Lockers

- Introduction..... 54
- Vanguard Lockers ..... 56
- QuickShip Vanguard Lockers ..... 58
- Guardian Lockers ..... 60
- Invincible II Lockers ..... 62
- All-Welded Lockers ..... 64
- Angle Iron Lockers ..... 66
- Stadium Lockers ..... 68
- Patriot Lockers ..... 70
- Rapid Response Duffel Lockers ..... 78
- Locker Accessories..... 80
- Basket Racks/Special Purpose Lockers ... 85
- Defiant II / ADA Lockers ..... 86
- Color Information ..... 87

## GREENGUARD

All products manufactured by Penco Products are **GREENGUARD Gold Certified** through UL Environment's GREENGUARD Certification Program. This certification signifies that Penco's products are in compliance with the stringent chemical emissions guidelines set by UL Environment.



Accredited courses are available to design professionals and fulfill credit requirements for AIA, GBCI, IDCEC. Contact a Penco Sales Manager for more information.

# Clipper® Shelving

## Defined

### Clipper Hi-Performance Shelving Systems

At the heart of the Clipper Shelving System is the ingenious Penco Clipper Clip. It is easily installed, holds the shelf firmly in place, can be repositioned at any time, and actually helps make the shelving more rigid.

Clipper® Shelving features Hi-Performance® Box Beam Shelves, which offer an exceptional strength to weight ratio. Clipper Shelving offers a wide variety of sizes and capacities too. This gives you the flexibility to provide top quality storage for a simple back room area up to a sophisticated multi-level or high-rise application.



### How To Order Clipper Units

Virtually all shelving storage needs may be satisfied by ordering standard shelving units as illustrated on the following pages. These units are shipped KD with all required components, shelf clips, hardware and assembly instructions.

### Choice of Post Arrangements

Penco standard shelving units employ box posts at front and offset angle posts at rear for each section. Other post assembly plans may be employed using offset angle posts at front and rear, when ordered as individual component parts.

### Growth Dimension Considerations

To determine the overall dimension of a continuous row of shelving employing box and angle posts, refer to detail drawings below.

#### To order standard 87" high units:

1. Determine the shelving type desired (open, closed or ledge)
2. Determine shelf width and depth.
3. Order by catalog number as many basic units as required to form a continuous row of shelving.
4. Order by catalog number one ending kit to end each row.
5. Select the appropriate accessories for your application.

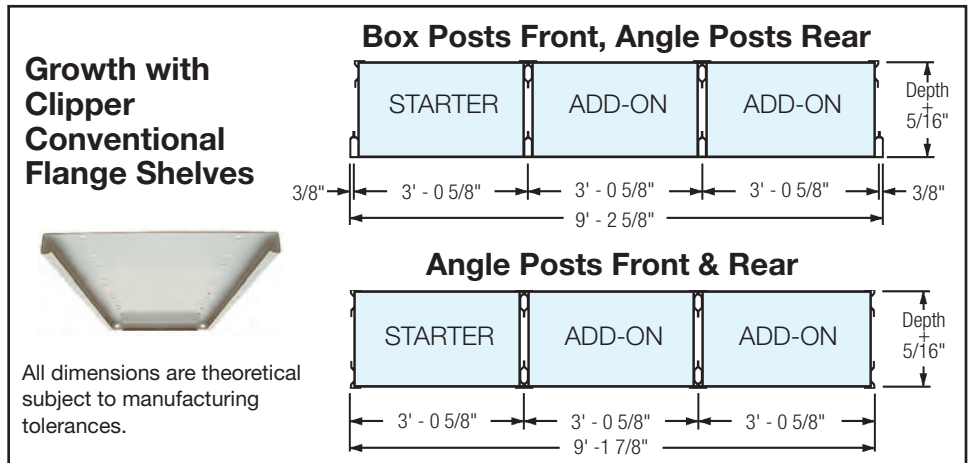
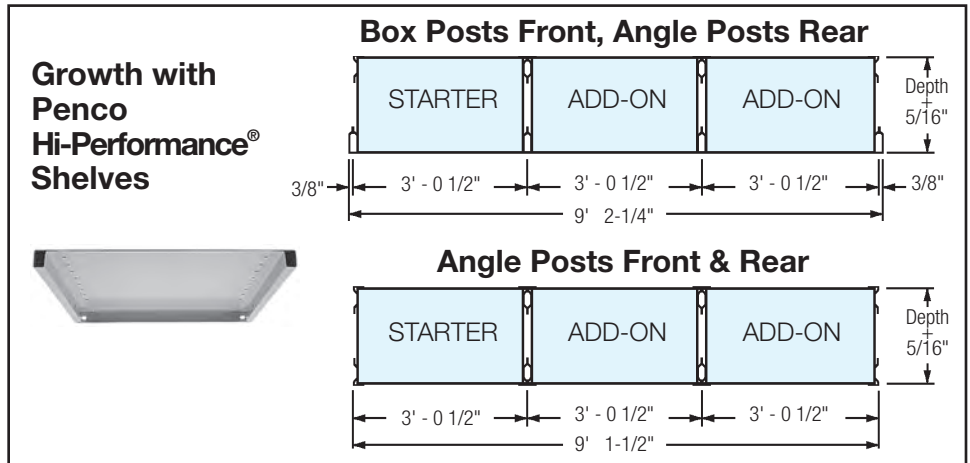

Clipper Growth Chart (With box posts at front, angle posts at rear)			
No. of Units In a Row	36" Wide Sections	42" Wide Sections	48" Wide Sections
1	3' 1-3/8"	3' 7-3/8"	4' 1-3/8"
2	6' 2"	7' 2"	8' 2"
3	9' 2-5/8"	10' 8-5/8"	12' 2-5/8"
4	12' 3-1/4"	14' 3-1/4"	16' 3-1/4"
5	15' 3-7/8"	17' 9-7/8"	20' 3-7/8"
6	18' 4-1/2"	21' 4-1/2"	24' 4-1/2"
7	21' 5-1/8"	24' 11-1/8"	28' 5-1/8"
8	24' 5-3/4"	28' 5-3/4"	32' 5-3/4"
9	27' 6-3/8"	32' 0-3/8"	36' 6-3/8"
10	30' 7"	35' 7"	40' 7"
11	33' 7-5/8"	39' 1-5/8"	44' 7-5/8"
12	36' 8-1/4"	42' 8-1/4"	48' 8-1/4"
13	39' 8-7/8"	46' 2-7/8"	52' 8-7/8"
14	42' 9-1/2"	49' 9-1/2"	56' 9-1/2"
15	45' 10-1/8"	53' 4-1/8"	60' 10-1/8"
16	48' 10-3/4"	56' 10-3/4"	64' 10-3/4"
17	51' 11-3/8"	60' 5-3/8"	68' 11-3/8"
18	55' 0"	64' 0"	73' 0"
19	58' 0-5/8"	67' 6-5/8"	77' 0-5/8"
20	61' 1-1/4"	71' 1-1/4"	81' 1-1/4"

# Clipper® Shelving

## Versatile Shelving & Accessories

Versatile Clipper Shelving can be accessorized for any job.

### Back Panel

Completely closes the back of shelving units and provides lateral stability.

### Full Height Dividers

Used to subdivide the shelf opening into smaller units. Punched top and bottom for attachment to shelves.

### Heavy Duty Modular Drawers

Provides secure high density storage for small parts. Contact your Penco representative for more information.

### Shelf Boxes

Strong steel open topped box for storing small parts. Equipped with built-in stop.

### Partial Divider

Divides shelf surface into sections.

### Bin Front

To retain small bulk parts on shelf.

### Base Strip

Designed to close the space between the bottom shelf and floor to promote good housekeeping.

### Clipper Hi-Performance® Shelf

Available in 19 sizes and 4 classes of load carrying capacity. May be clipped or bolted to posts.

### Box Post

Used as a common front post or row end. Allows independent 1" vertical adjustability and access to the full shelf width.

### Offset Angle Post

Roll formed for strength and punched on 1" centers for shelf adjustment. Can be used at front or back of unit.

### Sliding Divider

Formed to fit around front and rear flanges of the shelf. May be positioned anywhere along shelf surface.

### Back Braces

Attaches to rear posts of open type shelving to ensure lateral stability.

### Side Braces

Eliminates front to back sway on open type shelving.



**Label Holder**, Accepts 7/8" labels.

### Side Panel

Steel sheet used to enclose shelving sides or as a partition between sections placed side by side.



### Sway Braces

Open shelving units, 87' high or shorter, must have at least one set of side sway braces per side and one set of back braces. Both side and back braces may be common with adjacent units. For multiple level, deck-over or high-rise shelving structures, the lowest set of braces should be within 6" of the floor. For posts over 87" high up to 123", order two sets of side and rear braces for each unit. Posts taller than 123" may require additional bracing.

For brace location requirements in regions where there is seismic activity, contact a local consultant or the Penco Product Management and Systems Engineering Department.



**CLIPPER**  
SHELVING

# Clipper® Shelving

## Open Shelving Units

### Open Type Shelving

Open type shelving is the basic and most economical shelving design for general purpose use. Backs and sides are open, except that sections are stabilized by sway braces.

For convenient ordering, 36 different open configurations of Basic Units are shown below with their respective End Kits. The completed units below utilize Heavy Duty Hi-Performance® Shelves with box posts at front and offset angle posts at rear. Label holders are not included. Refer to page 4 for ordering instructions.

Many other configurations can be designed from the component parts and accessories on the following pages.

#### Basic Unit

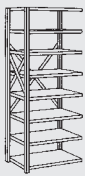

- 1 Box Post
- 2 Angle Posts
- 1 Set Side Braces
- 1 Set Back Sway Braces
- Shelves
- Hardware

#### End Kit



- 1 Box Post
- 1 Set Side Braces
- Hardware



**CLIPPER**  
SHELVING

### Clipper Open Units

Unit Width	Unit Depth	Unit Height	Capacity Per Shelf**	5 Shelf Basic Cat. No.	6 Shelf Basic Cat. No.	7 Shelf Basic Cat. No.	8 Shelf Basic Cat. No.	End Kit Cat. No.
36" Wide Units	12"	87"	800 lb	1H7015	1H7016	1H7017	1H7018	101287
	18"	87"	850 lb	1H7025	1H7026	1H7027	1H7028	101887
	24"	87"	800 lb	1H7035	1H7036	1H7037	1H7038	102487
42" Wide Units	12"	87"	600 lb	1H7045	1H7046	1H7047	1H7048	101287
	18"	87"	600 lb	1H7055	1H7056	1H7057	1H7058	101887
	24"	87"	600 lb	1H7065	1H7066	1H7067	1H7068	102487
48" Wide Units	12"	87"	500 lb	1H7075	1H7076	1H7077	1H7078	101287
	18"	87"	500 lb	1H7085	1H7086	1H7087	1H7088	101887
	24"	87"	530 lb	1H7095	1H7096	1H7097	1H7098	102487

\*\* For Evenly Distributed Load

# Clipper® Shelving

## Closed Shelving Units



Front Bases must be ordered separately.

### Closed Type Shelving

Closed type shelving units are covered on three sides with steel panels to provide stability, protection and to promote cleanliness of stored items. Optional locking doors may be added for greater security.

The 36 configurations shown below with their respective End Kits employ Heavy Duty Hi-Performance® shelves with box posts at the front and offset angle posts at the rear. Label holders and closed front bases are not included and must be ordered separately.

Refer to page 4 for ordering instructions. Many other configurations can be designed from the component parts and accessories on the following pages.

#### Basic Unit



- 1 Box Post
- 2 Angle Posts
- 1 Side Panel
- 1 Back Panel
- Shelves
- Hardware

#### End Kit



- 1 Box Post
- 1 Side Panel
- Hardware

### Clipper Closed Units

Unit Width	Unit Depth	Unit Height	Capacity Per Shelf**	5 Shelf Basic Cat. No.	6 Shelf Basic Cat. No.	7 Shelf Basic Cat. No.	8 Shelf Basic Cat. No.	End Kit Cat. No.
36" Wide Units	12"	87"	800 lb	1H8015	1H8016	1H8017	1H8018	1C1287
	18"	87"	850 lb	1H8025	1H8026	1H8027	1H8028	1C1887
	24"	87"	800 lb	1H8035	1H8036	1H8037	1H8038	1C2487
42" Wide Units	12"	87"	600 lb	1H8045	1H8046	1H8047	1H8048	1C1287
	18"	87"	600 lb	1H8055	1H8056	1H8057	1H8058	1C1887
	24"	87"	600 lb	1H8065	1H8066	1H8067	1H8068	1C2487
48" Wide Units	12"	87"	500 lb	1H8075	1H8076	1H8077	1H8078	1C1287
	18"	87"	500 lb	1H8085	1H8086	1H8087	1H8088	1C1887
	24"	87"	530 lb	1H8095	1H8096	1H8097	1H8098	1C2487

\*\* For Evenly Distributed Load

# Clipper® Shelving

## 36" Wide Bin Units

Clipper Shelving Bin Units are closed units with Heavy Duty Hi-Performance shelves, in various quantities, plus dividers and bin fronts as required. Offset angle posts are used at the rear of each unit, and box posts at the front. Order one End Kit to finish a unit or row of units. Front bases are included. Label holders must be ordered separately. This and the following page catalog 36" & 48" wide units, but many other configurations are possible by ordering component parts.

NOTE: Bin widths are nominal. They are measured from the hole centers on the shelves, not the vertical bead of the dividers.

**CLIPPER**  
SHELVING



### 36" Wide Clipper Bin Units

		9 Openings 8 @ 36" x 9" 1 @ 36" x 12"	13 Openings 12 @ 36" x 6" 1 @ 36" x 12"	21 Openings 21 @ 12" x 12"	21 Openings 21 @ 12" x 12" 7 - 3" Bin Fronts	End Kit
Unit Depth	Unit Height	9 Openings Cat. No.	13 Openings Cat. No.	21 Openings Cat. No.	21 Openings 3" Bin Fronts Cat. No.	End Kit Cat. No.
12"	87"	1H6109	1H6113	1H6121	1H6621	1C1287
18"	87"	1H6209	1H6213	1H6221	1H6521	1C1887
24"	87"	1H6309	1H6313	1H6321	1H6421	1C2487

### 36" Wide Clipper Bin Units

		29 Openings 16 @ 9" x 9" 4 @ 9" x 12" 9 @ 12" x 12" 8 - 3" Bin Fronts	35 Openings 32 @ 9" x 9" 3 @ 12" x 12"	37 Openings 24 @ 9" x 6" 4 @ 9" x 12" 9 @ 12" x 12"	43 Openings 24 @ 6" x 6" 9 @ 12" x 9" 4 @ 9" x 9" 6 @ 12" x 12"	End Kit
Unit Depth	Unit Height	29 Openings Cat. No.	35 Openings Cat. No.	37 Openings Cat. No.	43 Openings 3" Bin Fronts Cat. No.	End Kit Cat. No.
12"	87"	1H6129	1H6135	1H6137	1H6143	1C1287
18"	87"	1H6229	1H6235	1H6237	1H6243	1C1887
24"	87"	1H6329	1H6335	1H6337	1H6343	1C2487



# Clipper® Shelving

## 48" Wide Bin Units



### 48" Wide Clipper Bin Units

		9 Openings 8 @ 48" x 9" 1 @ 48" x 12"	13 Openings 12 @ 48" x 6" 1 @ 48" x 12"	28 Openings 28 @ 12" x 12"	28 Openings 28 @ 12" x 12" 7 - 3" Bin Fronts	End Kit
<b>Unit Depth</b>	<b>Unit Height</b>	<b>9 Openings Cat. No.</b>	<b>13 Openings Cat. No.</b>	<b>28 Openings Cat. No.</b>	<b>28 Openings 3" Bin Fronts Cat. No.</b>	<b>End Kit Cat. No.</b>
12"	87"	1H6409	1H6413	1H6428	1H6328	1C1287
18"	87"	1H6509	1H6513	1H6528	1H6228	1C1887
24"	87"	1H6609	1H6613	1H6628	1H6128	1C2487

### 48" Wide Clipper Bin Units

		42 Openings 16 @ 7-1/2" x 9" 8 @ 9" x 9" 4 @ 7-1/2" x 12" 2 @ 9" x 12" 12 @ 12" x 12" 8 - 3" Bin Fronts	52 Openings 32 @ 7-1/2" x 9" 16 @ 9" x 9" 4 @ 12" x 12"	54 Openings 24 @ 7-1/2" x 6" 12 @ 9" x 6" 4 @ 7-1/2" x 12" 2 @ 9" x 12" 12 @ 12" x 12"	58 Openings 32 @ 6" x 6" 12 @ 12" x 9" 4 @ 7-1/2" x 9" 2 @ 9" x 9" 8 @ 12" x 12"	End Kit
<b>Unit Depth</b>	<b>Unit Height</b>	<b>42 Openings 3" Bin Fronts Cat. No.</b>	<b>52 Openings Cat. No.</b>	<b>54 Openings Cat. No.</b>	<b>58 Openings Cat. No.</b>	<b>End Kit Cat. No.</b>
12"	87"	1H6442	1H6452	1H6454	1H6458	1C1287
18"	87"	1H6542	1H6552	1H6554	1H6558	1C1887
24"	87"	1H6642	1H6652	1H6654	1H6658	1C2487

# Clipper® Shelving

## Ledge and Counter Units

### Ledge Units

Ledge type shelving is recommended where greater depth of the lower compartment is desired, and a convenient working height surface ledge is required. Seven Heavy Duty Hi-Performance® shelves are included plus a heavy gauge ledge top with a reinforcing pan welded to the bottom for extra strength. This provides a total of seven openings.

The units are available in open or closed construction and may be equipped with standard shelving accessories, including locking doors at the top and bottom. Units are 36" wide, 12" deep at the top, and 24" deep at the bottom. Overall height is 87"; the ledge top is 39" high.

The End Kit includes 2 ledge top finishing strips to provide a finished appearance at the sides of the ledge top. Order one End Kit to finish each single unit, or row of units.

### Counter Units

Penco steel counters present an extremely clean, classic appearance for over the counter or stock-room use. A smooth, extra heavy gauge reinforced counter top provides an excellent work surface. Three standard Heavy Duty Hi-Performance® Clipper shelves, adjustable on 1" centers, are used below. Units have box posts at all four corners and closed front bases.

The top is designed to butt against adjacent tops when more than one unit is used in a row for a continuous flush surface. One End Kit is required for each single unit, or to end a row of units. Two counter top finishing strips are included with each End Kit, to extend the top beyond the end and provide a finished appearance.

Counter Tops and Fronts may be purchased as separate components. Note that they may be used only when box posts are used at front and rear of unit.



Open Unit with End Kit



Closed Unit with End Kit

Front Bases are included with Closed Ledge Units.

Ledge Units				
Unit Width	Unit Depth	Unit Height	Unit Cat. No.	End Kit Cat. No.
Open Type Units				
36"	12" (Top) 24" (Bottom)	48" (Top) 39" (Bottom)	1H432L	19433E
Closed Type Units				
36"	12" (Top) 24" (Bottom)	48" (Top) 39" (Bottom)	1H434L	19435E



Front and rear views of 2 1H122C Basic Units plus 1 19125E End Kit

Counter Units				
Unit Width	Unit Depth	Unit Height	Unit Cat. No.	End Kit Cat. No.
Complete Units				
36"	24"	39"	1H122C	19125E
42"	24"	39"	1H123C	19125E
48"	24"	39"	1H124C	19125E
Counter Tops Only				
36"	24"	-	13670H	-
42"	24"	-	13680H	-
48"	24"	-	13690H	-
Counter Fronts Only				
36"	-	39"	13870H	-
42"	-	39"	13880H	-
48"	-	39"	13890H	-

# Clipper® Shelving

## Special Purpose Units

### Artwork Shelving

This efficient unit serves the need for storing, organizing and protecting artwork. It is a basic piece of storage equipment wherever artwork is maintained. The unit has 18 openings, each with a 26-3/4" clear vertical opening. The unit includes closed back, sides and base, four Hi-Performance® shelves and 15 dividers. Dividers adjust easily on 1-1/2" centers. Can be accessorized with lockable doors. Order End Kit to finish each unit or row. Shown in Light Putty (723) enamel.



### Open Shelf Filing Record Storage

A space-saving efficient unit designed for filing a variety of records in a safe, organized, easily accessible system. Special tabbed dividers insert into the shelf and special back bracket for divider stability. They adjust easily on alternate 1" and 2" centers. The unit features closed sides and base. A special bracket at each shelf level is pierced to accept one tab of the divider. Order End Kit to finish a unit or a row. Shown in Light Putty (723) enamel.



Artwork Shelving						
Unit Width	Unit Depth	Unit Height	No. of Shelves	No. of Dividers	Unit Cat. No.	End Kit Cat. No.
36"	24"	87"	4	15	1H6700	1C2487

Open Shelf Filing Record Storage						
Unit Width	Unit Depth	Unit Height	No. of Shelves	No. of Dividers	Unit Cat. No.	End Kit Cat. No.
36"	12"	87"	8	35	176709	1C1287

### X-Ray Shelving

An efficient, practical storage unit with a broad application throughout the healthcare industry for the protective storage of X-ray. The unit features Heavy Duty Hi-Performance shelves, closed back, sides, and base. 25 dividers are furnished in two sizes which adjust easily on 1-1/2" centers. The dividers attach to the shelf with strong plastic buttons. Order End Kit to finish each unit or row. Shown in Light Putty (723) enamel.



Refer to opening sizes in chart below.

X-Ray Shelving						
Unit Width	Unit Depth	Unit Height	No. of Shelves	No. of Dividers	Unit Cat. No.	End Kit Cat. No.
36"	18"	87"	6	25	1H6705	1C1887

Divider Quantities			
Unit Depth	Divider Height	No. of Dividers	Clear Opening Height
18"	16"	15	14-13/16"
18"	18"	10	16-13/16"

### Plan Shelving

Designed with the engineer, draftsman or architect in mind, this unit allows plans and drawings to be stored either rolled or flat. This unit provides 64 openings 6" x 36" x 6" for rolled storage and 9 openings 48" x 36" x 4" for flat storage. Unit includes Heavy Duty Hi-Performance shelves, closed back, sides and base. Can be accessorized with lockable doors. Order End Kit to finish each row. Shown in Light Putty (723) enamel.



Plan Shelving						
Unit Width	Unit Depth	Unit Height	No. of Shelves	No. of Dividers	Unit Cat. No.	End Kit Cat. No.
48"	36"	87"	18	56	1H6659	1C3687

**CLIPPER®**  
SHELVING

# Clipper® Shelving

## Shelving Components

### Box Posts

A high strength roll formed tubular box section usually used at unit fronts; permits full access to shelf width. Designed to be used in common between units, or at row ends. Permits vertical shelf adjustment on 1" centers using clips or nuts & bolts. Internal flange is punched on 3" centers to accept side sway bracing or closed side panels.

### Offset Angle Posts

A roll formed high strength post which permits 1" vertical shelf adjustment using clips or nuts & bolts. Can be used at rear of units, or at front and rear. Offset recess adds rigidity and allows for independent shelf clip adjustment. Ends of flanges are punched on 3" centers to accept sway braces or closed panels.

### Closed Upright Assemblies

Steel End or Intermediate Panels are used to close the sides of 87" tall shelving units and are securely welded to posts for rigidity.

### Small Components

**A & B. Clipper Clips** - One piece 14 gauge compression clip for box and offset angle posts to hold shelf securely. **A.** For Hi-Performance Shelves; **B.** For Standard Flange Shelves.

**C. Post Splice** - Used to join Box or Angle posts for high-rise or multi-level shelving applications.

**D. Floor Anchor Clip (Foot Plate)** Punched for fastening posts to floor. Bolts to post.

**E. Floor Protector** - To distribute unit load and protect floor. For box and angle posts. Not for use on high-rise or multi-level shelving.

**F. Anchors** - For securing shelving posts to a concrete floor when Floor Anchor Clips are used. Use the longer anchor #9281 in seismic zones higher than 2A.

**G. Heavy Duty Foot Plate** - For box, single or double angle posts in high seismic areas.

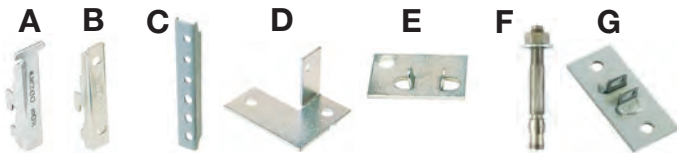

### Small Components

Letter	Unit Description	Cat. No.
A	Clipper Clip (Hi-Performance)	10002Z
B	Clipper Clip (Standard Flange)	100001Z
C	Post Splice	10030H
D	Floor Anchor Clip, 3-1/2" x 2-7/8"	10006Z
-	Shim for "D", 3-1/2" x 2-7/8", 11 Gauge	10011
E	Floor Protector, 1-3/4" x 2-5/8"	10007Z
F	Anchor, 3/8" x 2-1/4"	9280
	Anchor, 3/8" x 3-3/4"	9281
G	Foot Plate, Heavy Duty, 5-1/2" x 2-3/8", 7 Ga.	1ACX322H
-	Shim, Hvy. Duty for "G", 5-1/2" x 2-3/8", 7 Ga.	1ACX330



Box Posts		
Unit Height	14 Gauge Cat. No.	16 Gauge Cat. No.
39"	1B4039C	-
48"	1B4048C	-
75"	1B4075C	-
87"	1B4087C	1B6087C
99"	1B4099C	-
123"	1B4123C	-
147"	1B4147C	-



Offset Angle Posts		
Unit Height	14 Gauge Cat. No.	16 Gauge Cat. No.
39"	1A4039C	-
48"	1A4048C	-
75"	1A4075C	-
87"	1A4087C	1A6087C
99"	1A4099C	-
123"	1A4123C	-
147"	1A4147C	-

### 14 Gauge Clipper Post Capacities (Pounds)

Unbraced Length (Max. Space Between Shelves)	Box Post Capacity	Single Angle Capacity	Double Angle Capacity (Bolted on 12" Centers)
9"	6740 lb	3760 lb	8270 lb
12"	6450 lb	3490 lb	7670 lb
15"	6070 lb	3130 lb	6880 lb
18"	5630 lb	2700 lb	5940 lb
21"	5090 lb	2180 lb	4790 lb
24"	4480 lb	1680 lb	4460 lb

### Closed Upright Assemblies

Unit Depth	Unit Height	Cat. No.
<b>Box Post</b>		
		1 Box Post, 1 Angle Post, 1 Side Panel
12"	87"	15412CC
18"	87"	15418CC
24"	87"	15424CC
<b>Offset Angle Post</b>		
		2 Offset Angles, 1 Side Panel
12"	87"	15412AC
18"	87"	15418AC
24"	87"	15424AC
<b>Box Post Intermediate</b>		
		1 Box Post, 2 Offset Posts, 1 Side Panel
12"	87"	15412BC
18"	87"	15418BC
24"	87"	15424BC

# Clipper® Shelving

## Shelving Components

### For Open Construction

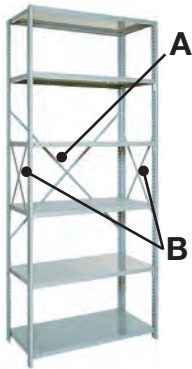

#### Sway Braces (A & B)

Sway braces provide stability for Open Type shelving. They are furnished in sets of two braces to fasten to one back or side of a unit. Hardware included.

Back sway braces (A.) eliminate lateral sway. They fasten to the flanges of offset angle posts used at the rear of units. Braces also bolt to each other at the center hole to ease installation.

Side sway braces (B.) eliminate front to back sway. They fasten to the flanges of the front and rear posts.



Sway Braces					
Letter Code	Description	Unit Width	Unit Depth	Overall Piece Length	Cat. No.
A	Back Sway Braces	24"	-	45"	12045A
		30"	-	50"	12050A
		36"	-	50-3/4"	12036H
		42"	-	57-1/8"	12042H
		48"	-	65-1/2"	12048H
B	Side Sway Braces	-	9"	11"	12011S
		-	12"	15"	12015S
		-	15"	19"	12019S
		-	18"	26"	12026S
		-	24"	34"	12034S
		-	30"	45"	12045S
		-	32"	46-1/4"	12046S
		-	36"	49"	12049S

### For Closed Construction

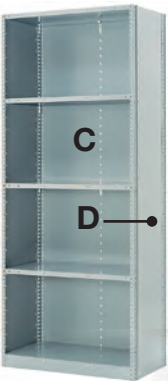

#### Back and Side Panels (C & D)

Panels to enclose the backs and sides of Closed Type Shelving provide unit stability while giving greater protection to the shelving contents.

Back panels (C.) bolt to the flanges of offset angle posts at the rear of units. The center of the back is held tight against a shelf with a "back panel clip" furnished with each back. Common backs may be used when units are placed back-to-back, provided that units are securely bolted together.

Backs 36" wide are furnished in one piece through 87" high. Over 87" high, they are split horizontally (2 pieces). 42" & 48" wide backs are furnished in one piece through 51" high; above 51" they are split horizontally (2 pieces). Hardware included.

Side panels (D.) fasten to the flanges in the front and rear posts. Furnished in one piece through 87" high. As an alternate to side panels, you may order Closed Upright Assemblies (shown on the previous page) which combine posts and side panels in one welded unit.



Back and Side Panels									
Letter Code	Description	Shelf Width	Shelf Depth	39" Height	48" Height	51" Height	75" Height	87" Height	99" Height
C	Back Panels	24"	-	-	-	-	-	12340H	-
		30"	-	-	-	-	-	12440H	-
		36"	-	12500H	-	12510H	12530H	12540H	12550H
		42"	-	12600H	-	12610H	12630H	12640H	12650H
		48"	-	12700H	-	12710H	12730H	12740H	12750H
D	Side Panels	-	9"	-	-	-	-	11340H	-
		-	12"	11400H	11409H	11410H	11430H	11440H	11450H
		-	15"	-	-	-	-	11540H	-
		-	18"	11600H	11609H	11610H	11630H	11640H	11650H
		-	24"	11700H	-	11710H	11730H	11740H	11750H
		-	30"	11800H	-	-	-	11840H	11850H
		-	36"	11900H	-	-	11930H	11940H	11950H

# Clipper® Shelving

## Hi-Performance® Shelves

Clipper Hi-Performance® Shelves maximize load handling capacity through a design which shapes the front and rear flanges into rigid tubular box beams. The box shape provides two vertical surfaces in each box-flange that inherently give it a high strength-to-weight ratio. Additional reinforcing bars or angles are not used with Hi-Performance shelves. Reinforcing options for Class 3 shelves are shown at right.



The shelves are efficiently manufactured from high strength cold rolled steel on a modern automated roll forming mill.

For additional strength, front and rear flanges are welded to the underside of the shelf on 3" centers. Shelf corners are lapped and welded.

Shelves are available in a wide variety of sizes shown below in the capacity chart. All shelves are punched on 1.5" centers to accept shelving accessories such as dividers, label holders and bin fronts.

### A. Class 3 Side Shelf Support (pairs)

Used to support Center Support in Class 3 applications.

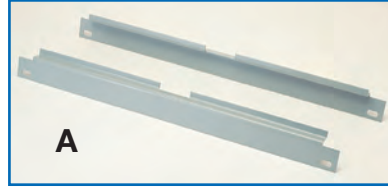

Class 3 Side Shelf Support	
Unit Depth	Cat. No.
18"	1H830H
24"	1H840H
30"	1H850H
36"	1H860H

### B. Class 3 Center Support

Runs left to right beneath the mid-point of the shelf for conversion to Class 3. Supported by side shelf supports.

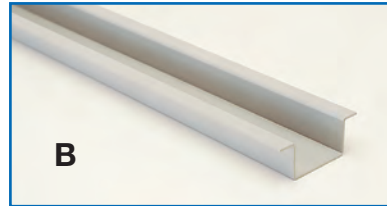

Class 3 Center Support	
Unit Width	Cat. No.
36"	H13736C
42"	H13742C
48"	H13748C

## Clipper Hi-Performance® Shelf Capacities

		Class 0 Medium Duty High Strength Steel		Class 1 Heavy Duty High Strength Steel		Class 2 Extra Heavy Duty High Strength Steel		Class 3 Extra Heavy Duty With Reinforcing*
Unit Width	Unit Depth	Cat. No.	Capacity	Cat. No.	Capacity	Cat. No.	Capacity	Capacity
36"	12"	1H223612C	500 lb	1H203612C	800 lb	1H183612C	1100 lb	-
	15"	1H223615C	500 lb	1H203615C	800 lb	1H183615C	1100 lb	-
	18"	1H223618C	500 lb	1H203618C	850 lb	1H183618C	1200 lb	2000 lb
	24"	1H223624C	500 lb	1H203624C	800 lb	1H183624C	1250 lb	2000 lb
	30"	-	-	1H203630C	500 lb	1H183630C	900 lb	2000 lb
	36"	-	-	1H203636C	500 lb	1H183636C	900 lb	2000 lb
42"	12"	-	-	1H204212C	600 lb	1H184212C	1100 lb	-
	15"	-	-	1H204215C	600 lb	1H184215C	1100 lb	-
	18"	-	-	1H204218C	600 lb	1H184218C	1050 lb	1600 lb
	24"	-	-	1H204224C	600 lb	1H184224C	900 lb	1600 lb
	30"	-	-	1H204230C	625 lb	1H184230C	1000 lb	1600 lb
	32"	-	-	1H204232C	525 lb	1H184232C	950 lb	1600 lb
48"	12"	1H224812C	350 lb	1H204812C	500 lb	1H184812C	750 lb	-
	15"	-	-	1H204815C	500 lb	1H184815C	850 lb	-
	18"	1H224818C	375 lb	1H204818C	500 lb	1H184818C	900 lb	1200 lb
	24"	1H224824C	400 lb	1H204824C	500 lb	1H184824C	900 lb	1200 lb
	30"	-	-	1H204830C	500 lb	1H184830C	750 lb	1200 lb
	36"	-	-	1H204836C	500 lb	1H184836C	750 lb	1200 lb

\* Class 3 Capacities are based upon the use of Extra Heavy Duty Shelves with (A) Side Shelf Supports and (B) Center Support for additional capacity. Must use nuts and bolts for shelves, not clips. All shelves are supplied with Clipper Clips. All shelf load capacities are in pounds for evenly distributed loads, and include a safety factor of 1.65.

# Clipper® Shelving

## Conventional Flange Shelves

Clipper Conventional Flange Shelves are fabricated from 18 gauge cold rolled steel. All sides of the shelf are double flanged for added strength. The corners are lapped and welded for positive reinforcement. Shelves secure to posts with Penco's unique compression Clipper clip, or can be bolted. Shelves are punched for divider placement on alternating 1" and 2" centers. Reinforcing options are shown at right.



All shelves are supplied with Clipper Clips. Nuts and bolts may be substituted upon request. All capacities are for safe static loads distributed uniformly over the entire shelf surface as determined by test. Refer all "Pass Thru" or other unusual conditions to Penco Engineering for their evaluation.

**Class 0** - For Normal Loads. No additional reinforcement.

**Class 1-B** - For Normal Loads requiring impact resistance. A standard Class 0 Shelf with the addition of a 1" x 1/8" reinforcing bar in the front flange.

**Class 2-B** - For Medium Loads. Same as Class 1-B with the addition of a reinforcing bar in the rear flange.

**Class 2-A** - For Medium to Heavy Loads. A standard Class 0 shelf with the addition of field installed 1" x 1" x 1/8" reinforcing angles in front and rear flanges.

### A. Reinforcing Bar

Rollled steel bars insert in the shelf channel for reinforcement. Hardware is included. Not for use with Hi-Performance Shelves.

A - Reinforcing Bar			
Width	Depth	Height	Cat. No.
30"	1/8"	1-3/32"	16660H
36"	1/8"	1-3/32"	16670H
42"	1/8"	1-3/32"	16680H
48"	1/8"	1-3/32"	16690H

### B. Reinforcing Angle

1/8" thick rolled steel angles added to the shelf flanges for developing class 2A shelves. Hardware is included. Not for use with Hi-Performance shelves.

B - Reinforcing Angle			
Width	Depth	Height	Cat. No.
36"	1"	1"	16520H
42"	1"	1"	16530H
48"	1"	1"	16690H



### Clipper Conventional Flange Shelf Capacities - 18 Gauge

		Class 0		Class 1-B		Class 2-B		Class 2-A	
Unit Width	Unit Depth	Deflection @ Center Ft Edge	Cat. No.	Capacity	Capacity	Capacity	Capacity	Capacity	Capacity
24"	12"	.200"	12810C	990 lb		1270 lb	1580 lb		
	18"	.200"	12830C	1110 lb		1430 lb	1430 lb		
	24"	.200"	12840C	1140 lb		1090 lb	1090 lb		
30"	12"	.250"	12910C	760 lb		980 lb	1230 lb		
	18"	.250"	12930C	820 lb		1060 lb	1320 lb		
	24"	.250"	12940C	920 lb		1030 lb	1030 lb		
36"	9"	.300"	13000C	620 lb	NOTE: Class 1 shelves do not have any more load carrying capabilities over Class 0, but should be used where impact or concentrated loads occur along the front edge.	790 lb	980 lb		
	12"	.300"	13010C	620 lb		810 lb	1010 lb		
	15"	.300"	13020C	620 lb		820 lb	1020 lb		
	18"	.300"	13030C	660 lb		850 lb	1050 lb		
	24"	.300"	13040C	700 lb		920 lb	1090 lb		
	30"	.300"	13050C	790 lb		860 lb	860 lb		
42"	12"	.350"	13110C	520 lb		740 lb	740 lb		
	15"	.350"	13120C	520 lb		690 lb	850 lb		
	18"	.350"	13130C	550 lb		690 lb	860 lb		
	24"	.350"	13140C	580 lb		710 lb	880 lb		
	30"	.350"	13150C	620 lb		740 lb	930 lb		
	36"	.350"	13160C	680 lb		800 lb	800 lb		
48"	12"	.400"	13210C	450 lb		740 lb	740 lb		
	18"	.400"	13230C	470 lb		590 lb	740 lb		
	24"	.400"	13240C	480 lb		600 lb	770 lb		
	30"	.400"	13250C	510 lb		640 lb	790 lb		
	36"	.400"	13260C	550 lb		670 lb	830 lb		
						720 lb	720 lb		

# Clipper® Shelving

## Shelving Accessories

### Finished End Panels



Formed sheet steel panels used to finish the end of a shelving row. Panels attach to posts to cover holes and hardware. Presents an attractive and finished appearance. Must be used with Box Post at front, Angle Posts at rear.

Finished End Panels		
Unit Depth	Unit Height	Cat. No.
12"	87"	18241H
18"	87"	18440H
24"	87"	18540H

### Sliding Doors

Flanged on all 4 sides and reinforced. Doors slide on quiet, smooth-running nylon rollers and guides. Designed for use with two 36" wide units side by side. Complete with grooved key cylinder lock and 2 keys. Hardware included. Not for use with Modular Drawers.



Sliding Doors			
Unit Width	Door Frame Height	Unit Height	Pair Cat. No.
72"	36"	39"	1H907236
72"	84"	87"	1H907284

### Shelf Boxes



This strong compact open topped box measures 4-5/8" high and is ideal for storing small parts where shelves are spaced on 6" centers. It features a full width drawer pull, built-in drawer stop and recessed label holder. Drawers are slotted on 1" centers to accommodate steel dividers that are ordered separately (see below).

Box guides prevent shelf boxes from sliding behind the front posts. Order 2 Shelf Box Guides for each shelf of boxes. Box Guide Cat. No. 10038H.

Shelf Boxes			
Unit Width	Unit Depth	Boxes Per 36" Shelf	Cat. No.
5-5/8"	11"	6	38030
8-7/16"	11"	4	38035
11-1/4"	11"	3	38040
5-5/8"	17"	6	38180
8-7/16"	17"	4	38185
11-1/4"	17"	3	38190
5-5/8"	23"	6	38255
8-7/16"	23"	4	38260
11-1/4"	23"	3	38265

### Shelf Box Dividers

Dividers have built-in label holders and drop into slots in the box sides. Adjustment on 1" centers allow you to compartmentalize each box. Galvanized finish.



Shelf Box Dividers		
Unit Width	Unit Height	Cat. No.
5-5/8"	4-1/2"	38306
8-7/8"	4-1/2"	38307
11-1/4"	4-1/2"	38308

### Sliding Reference Shelves



A 12" deep sliding pull-out shelf designed to aid shelving users who need a work surface while working in the shelving area. Fastens beneath any Hi-Performance shelf size shown below, and neatly slides out of the way when not needed.

Sliding Reference Shelves		
For Shelf Size (In.)		Catalog Number
Width	Depth	
36	12	10RS03612H
36	15	10RS03615H
36	18	10RS03618H
42	12	10RS04212H
42	15	10RS04215H
42	18	10RS04218H
42	30	10RS04230H
42	32	10RS04232H
48	12	10RS04812H
48	15	10RS04815H
48	18	10RS04818H





# Clipper® Shelving

## Shelving Accessories

### Front Base Strips



Closes the space between the floor and bottom shelf. Hardware included. The 4" high base is for use with the heavy duty foot plate.

Front Base Strip		
Unit Width	Unit Height	Cat. No.
24"	3"	14500H
30"	3"	14510H
36"	3"	14520H
36"	4"	14525H
42"	3"	14530H
48"	3"	14540H

### Swinging Doors



3 Point latching with locking handle and 2 keys. Doors are pre-hung at the factory on a welded frame for easy assembly and good fit. Can be used on standard ledge or counter units up to 87" high. Order doors separately from units. Door can be attached to box posts or angle posts. Base strips

should be ordered to close the opening between the door frame and the floor.

NOTE: Not for use with Modular Drawers.

Swinging Doors			
Unit Width	Door Frame Height	Unit Height	Pair Cat. No.
For Below Ledge or Counter Height			
36"	36"	39"	19600H
For Above Ledge Unit			
36"	48"	48"	19610H
For Standard Shelving Units			
36"	73"	75"	19630H
36"	85"	87"	19640H
48"	36"	39"	19646H
48"	85"	87"	19650H

### A. - Bin Front

A formed steel panel partially enclosing the front opening of a shelf to keep bulk items within a bin. 1" & 2" Bin Fronts attach to the front of the shelf with bolts & nuts. 3" high Bin Front attaches to posts with metal clips. Hardware included.

### B. - Sliding Divider

Formed to fit around front and rear flanges on the shelf. Position anywhere on surface. No hardware needed. For Hi-Performance Shelves.

### C. - Partial Dividers

Partially subdivides shelf to separate stored items. Hardware included.

### D. - Full Height Dividers

Used to divide a shelf opening into smaller units. Divider has a beaded front edge for strength and safety. Hardware included. NOTE: For Class 3 shelving applications, contact your representative regarding special notching of dividers.

### E. - Label Holders

A formed steel strip that accepts 7/8" labels. Fastens to the shelf with plastic buttons (included).



### F. - Flue Spacer

A component that can provide a 6" open area between rows of back-to-back shelving to facilitate installation of fire suppression equipment (hardware included).

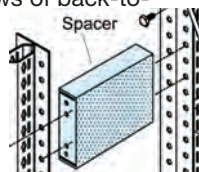

### A. - F. Accessories

Letter Code	Unit Desc.	Unit Width	Unit Depth	Unit Height	Cat. No.
A	Bin Front	36"	-	1"	14210H
		36"	-	2"	14220H
		36"	-	3"	14230C
		42"	-	3"	14330C
		48"	-	3"	14430C
B	Sliding Divider	-	12"	4"	1H4124C
		-	12"	6"	1H4126C
		-	18"	4"	1H4184C
		-	18"	6"	1H4186C
		-	24"	4"	1H4244C
C	Partial Dividers	-	12"	2"	16395H
		-	12"	4"	16410H
		-	18"	2"	16397H
		-	18"	4"	16430H
		-	24"	4"	16440H
D	Full Height Dividers	-	12"	6"	15600H
		-	12"	9"	15620H
		-	12"	12"	15640H
		-	12"	14"	15650H
		-	12"	18"	15670H
		-	15"	6"	15700H
		-	15"	12"	15740H
		-	18"	6"	15800H
		-	18"	9"	15820H
		-	18"	10"	15830H
		-	18"	12"	15840H
		-	18"	16"	15860H
		-	18"	18"	15870H
		-	18"	24"	15890H
		-	24"	6"	15900H
-	24"	9"	15920H		
-	24"	12"	15940H		
-	24"	18"	15970H		
-	24"	24"	15990H		
-	36"	18"	16170H		
E	Label Holders	24"	-	-	13900H
		30"	-	-	13910H
		36"	-	-	13920H
		42"	-	-	13930H
		48"	-	-	13940H
F	Flue Spacer	-	6"	4"	1ACX522H

# Clipper® Shelving

## QuickShip Shelving



For lead times and warehouse locations, go to:  
[pencoproducts.com/lead-times](http://pencoproducts.com/lead-times)  
[pencoproducts.com/quickship](http://pencoproducts.com/quickship)

### Basic Clipper Shelving OPEN QuickShip Units - 87" High



Unit Width	Shelf Depth	5 Shelf Cat. No.	6 Shelf Cat. No.	7 Shelf Cat. No.	8 Shelf Cat. No.
36"	12"	1H7015028	1H7016028	1H7017028	1H7018028
	18"	1H7025028	1H7026028	1H7027028	1H7028028
	24"	1H7035028	1H7036028	1H7037028	1H7038028
48"	12"	1H7075028	1H7076028	1H7077028	1H7078028
	18"	1H7085028	1H7086028	1H7087028	1H7088028
	24"	1H7095028	1H7096028	1H7097028	1H7098028

Pictured at left: a 5-shelf Open Basic Unit. It requires an Open End Kit for completion (see below).

### Basic Clipper Shelving CLOSED QuickShip Units - 87" High



Unit Width	Shelf Depth	5 Shelf Cat. No.	6 Shelf Cat. No.	7 Shelf Cat. No.	8 Shelf Cat. No.
36"	12"	1H8015028	1H8016028	1H8017028	1H8018028
	18"	1H8025028	1H8026028	1H8027028	1H8028028
	24"	1H8035028	1H8036028	1H8037028	1H8038028
48"	12"	1H8075028	1H8076028	1H8077028	1H8078028
	18"	1H8085028	1H8086028	1H8087028	1H8088028
	24"	1H8095028	1H8096028	1H8097028	1H8098028

Pictured at left: a 5-shelf Closed Basic Unit. It requires a Closed End Kit for completion (see below).

### Clipper QuickShip Components

Description	W	D	H	Cat. No.
Box Post	-	-	87"	1B4087028
Offset Angle Post	-	-	87"	1A4087028
Floor Anchor Clip	3-1/2"	2-7/8"	-	10006Z
Concrete Floor Anchor	3/8"	-	2-1/4"	9280
Back Sway Braces	36"	-	-	12036H028
	48"	-	-	12048H028
Side Sway Braces	-	12"	-	12015S028
	-	18"	-	12026S028
	-	24"	-	12034S028
Back Panels	36"	-	87"	12540H028
	48"	-	87"	12740H028
Side Panels	-	12"	87"	11440H028
	-	18"	87"	11640H028
	-	24"	87"	11740H028
Front Base Strips	36"	-	3"	14520H028
	48"	-	3"	14540H028

### Clipper Shelving QuickShip End Kits - 87" High

End Kits	Unit Depth	For OPEN Units Cat. No.	For CLOSED Units Cat. No.
Open	12"	101287028	1C1287028
Closed	18"	101887028	1C1887028
	24"	102487028	1C2487028

### Clipper® QuickShip Adjustable Shelving

- High Quality Industrial Grade
- Open and Closed Configurations
- 87" high units with Box & Angle Posts
- Shelves adjust on 1" vertical centers
- Heavy duty box beam shelves - 4 sizes
- Attractive 028 Gray powder coat finish
- Accessories - Front Bases, Anchors and Floor Anchor Clips

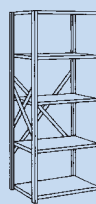

Open Basic Unit

Use an **OPEN Clipper Basic Unit** to start a single unit or a row of shelving. Add additional Clipper Basic Units to add to the row. To end a row or single unit, finish the unit with an **OPEN End Kit**.



Open End Kit



Closed Basic Unit

Use a **CLOSED Clipper Basic Unit** to start a single unit or a row of closed shelving. Add additional Closed Clipper Basic Units to add to the row. To end a row or single unit, finish the unit with a **CLOSED End Kit**.



Closed End Kit

### Heavy Duty Shelves & Capacities (Each Shelf comes with 4 Clipper Clips)

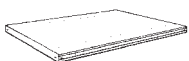

Size	Cat. No.	Capacity
36" W x 12" D	1H203612028	800 lbs.*
36" W x 18" D	1H203618028	850 lbs.*
36" W x 24" D	1H203624028	800 lbs.*
48" W x 12" D	1H204812028	500 lbs.*
48" W x 18" D	1H204818028	500 lbs.*
48" W x 24" D	1H204824028	500 lbs.*

\* Evenly Distributed Loads for Clipper Hi-Performance Heavy Duty Class 1 Shelves.

# Clipper® Shelving

## Specifications

**General:** All shelving shall comply with SMA and ANSI MH 28.1-1982 and in addition shall have the following characteristics:

**Posts:** All posts shall be punched for clip or nut and bolt construction. Shelves and accessories are to be vertically adjustable on 1" centers. Side sway braces or side panels to be attached to the side flange of the post. Bolts, nuts, and sway braces or panels shall not obstruct the full adjustability of the shelves.

**Box Post:** Box post to be roll formed and have overall dimensions of 3/4" wide x 2-7/16" deep. Box post to be flush within 1/4" of the face of the shelves when assembled.

**Offset Angle:** Offset angle post shall be roll formed and have overall dimensions of 1-1/8" wide x 2-1/2" deep. The rear flange shall be punched to accept sway braces or backs, the side flange shall be punched to accept side sway braces or side panels.

**Side Panels:** Shall be 24 gauge steel. Each side shall be punched with holes for bolting to posts.

**Backs:** Shall be 24 gauge steel with holes on each side for bolting to angle posts and in the middle for using a back panel clip.

**Sway Braces:** To be 12 gauge x 3/4" steel punched at each end for bolting to posts and at the center for strength and ease of assembly.

**Clipper Shelf Clip:** One piece 14 gauge rugged compression type to insert into either box or offset angle posts to form a positive four point connection. Clips shall have two claw-like hooks to seat firmly into post slots and two tabs at bottom to seat into post holes for a tight friction connection. All clips for all posts and shelves to be the same. Design shall offer a pre-clipping feature to simplify erection. Finish: zinc plated. All shelves are to have four independently adjustable clips.

**Shelves: Conventional Flange, Class "O":** Shall be 18 gauge steel with a 1-3/16" vertical face on all four sides, front and rear faces to have 17/32" return flange 90° with the edges coined upward to prevent snagging. Sides to have a 5/8" return flange 90°. All four shelf corners shall be closed by lapping and spot welding together to provide a firm, rigid shelf. Shelf shall be universally punched for use with all available accessories and for clip or bolted assembly. Shelves are available in 24", 30", 36", 42" and 48" widths and 9", 12", 15", 18", 24", 30" and 36" depths. Shelves can be reinforced by adding 1-3/32" x 11 ga. bars or 1" x 1" x 1/8" angles to front and back flanges.

**Shelves: Clipper Hi-Performance® Box Formed:** Medium Duty, Heavy Duty and Extra Heavy Duty are manufactured from cold rolled steel in three material thicknesses that provide up to three different shelf capacities per size. Shelves have 1-1/4" face on all four sides. Front and rear faces have four 90° bends providing a 3/4" x 1-1/4" high tubular shape with an 11/16" wide flange seated against the underside of the shelf. The flange is spot welded to the underside of the shelf on 3" centers. Sides have a 5/8" return flange 90°. All four corners are closed by lapping and spot welding together. Medium Duty and Heavy Duty shelf tabs for lapping and welding have formed ribs to maintain the same snug fit in the shelf clip as the extra heavy duty shelf. Overall, the shelf depth and width is 1/4" less than nominal. The shelf is punched for divider adjustment on 1-1/2" centers and for attachment of label holders, bin fronts and base fronts. Hi-Performance shelves are available in 36", 42", & 48" widths and 12", 15", 18", 24", 30" & 36" depths.

Extra Heavy Duty Reinforced (Class 3) Hi-Performance Shelves provide maximum capacity using Extra Heavy Duty shelves that are reinforced using 13 gauge side shelf supports bolted to the Clipper posts and 14

gauge 1-5/32" high hat shaped center supports held in place by a notch and flange in the side shelf support.

**Ledge Tops:** To be 14 gauge steel. Face of ledge to be 1-1/8" and have a center reinforcing pan. Ledge top to project 1-1/8" beyond the face of the post and to have two 14 gauge angles welded to underside for strength and bolting to post. Must be used with box posts below ledge.

**Ledge Tops:** To be manufactured from 14 gauge steel and furnished to give ledge top a finished appearance.

**Counter Tops:** To be 14 gauge steel. Face of counter top to be 1-1/8" and project 1-1/8" beyond face of post with a welded center reinforcing pan. Units to be furnished with box post front and rear for finished appearance. 14 gauge counter top ends can be furnished at the ends of all rows for a finished appearance.

**Counter Front:** To be 18 gauge steel attached with no exposed fasteners.

**Base Strip:** Shall be 18 gauge steel attached to face of shelf with bolts and nuts to close space between the bottom of the shelf and the floor.

**Label Holder:** Shall be 24 gauge steel with necessary holes for attaching to shelves with plastic push-in fasteners.

**Shelf Dividers:** 6" high through 20" high shall be 24 gauge, 24" high and over shall be 20 gauge. All divider front flanges shall have a 5/16" diameter bead. Top, bottom and rear flanges are 7/8". Dividers less than 24" high shall be attached with plastic push-in fasteners, 24" and higher are bolted.

**Partial Dividers:** Shall be 18 gauge steel with a 7/8" flange at the bottom. Attached with push-in Plastic Button fasteners.

**Sliding Divider:** To be 20 gauge steel manufactured to give infinite lateral adjustability. Divider portion shall be sloped 45° at front, 1/2" radius at front corner.

**Bin Fronts:** To be 18 gauge steel. One and two inch high bin fronts shall be bolted to the face of the shelf. Three inch high bin fronts to be attached to the post by use of 16 gauge zinc plated channel clips.

**Shelf Boxes:** To be 20 gauge steel with a rigid curled handle at the front of the box, punched with an integral card holder on front and rear. Box shall be 4-5/8" high to fit between shelves on 6" centers and shall be slotted to accept dividers on 1" centers.

**Shelf Box Dividers:** To be 20 gauge steel. Punched with an integral card holder.

**Swinging Doors:** Consist of a 16 gauge steel frame and 20 gauge doors, reinforced to prevent warping. Doors are riveted to three 5-knuckle hinges and have a three-point latching device with chrome plated key lock handle. Doors to be preassembled in the frame at factory.

**Sliding Doors:** Set of doors is 72" wide and cover two 36" wide units. Each door shall be 22 gauge with two or more 18 gauge reinforcing pans, recessed handle and nylon glides and rollers. Each set has 16 gauge channels welded at the top and bottom, and 20 gauge channels on the ends. Doors shall be contained in top, bottom and vertical channels. Right hand door has a provision for a cylinder lock.

**Foot Plates:** Shall be 13 gauge zinc plated steel and be used to protect floors.

**Finish:** Finish to be selected from manufacturer's standard colors. Surface to be pretreated with a multiple stage cleaning and metal preparation process. Finish coat of high grade pure polyester powder coat is applied and properly cured to paint manufacturer specifications to achieve optimum performance.

Clipper® and Hi-Performance® are registered trademarks of Penco Products, Inc.

PENCO RESERVES THE RIGHT TO VARY SPECIFICATIONS CONSISTENT WITH A POLICY OF CONTINUOUS PRODUCT IMPROVEMENT.



# Wide Span

## Introduction

### For High, Wide or Bulky Hand-Loaded Items

Penco Wide Span is the standard of the industry for shelving designed to contain wide, bulky loads. It bridges the storage gap between conventional shelving and pallet rack. The range of applications can be from a single unit (right) to a sophisticated multi-level picking system (bottom).

Penco Wide Span is easily the quickest shelving product to assemble. There are a minimum number of parts that snap or fit into place quickly and easily. No bracing to add and no hardware required. Not to be loaded with fork trucks.



Multi-level Wide Span Pick Module



Optional wire deck shelves.



Museum storage.



Auto part center storage.

### How To Order Wide Span Units

Wide Span Units are easy to order. Shown on the next page are common sizes of units for 3 levels of plywood shelves.

Many other sizes are available by ordering from the component parts on the following pages. Allow for the width of each upright post in planning your layout. The Wide Span Growth Chart on the next page illustrates this concept for your convenience.

To order Wide Span Shelving Units:

1. Order as many Basic Units as you need for your row of shelving.
2. Order one Rack Ending Kit to end each row or single unit (plywood must be purchased separately).

### Growth Dimension Considerations

When planning a row of Wide Span Shelving, allow for the 1-3/4" width of each upright post and 1/4" additional per bay for the thickness of the beam ends. The Wide Span Growth Chart on the following page shows typical growth for two 96" steel shelf units and 96-1/2" plywood beam units.

For safety purposes, we recommend that Wide Span Uprights be floor or wall anchored.

# Wide Span Wide Span Units

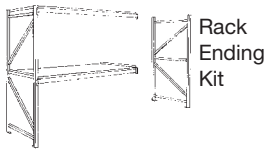

### Basic 2-Shelf Unit

- 1 Upright Frame
- 2 Steel Shelf Levels
- 2 Pair Side Shelf Supports
- 2 Pair Rigidity Beams

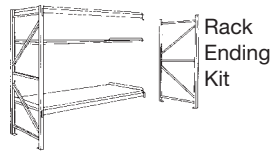

### Basic 3-Shelf Unit

- 1 Upright Frame
- 3 Steel Shelf Levels
- 3 Pair Side Shelf Supports
- 2 Pair Rigidity Beams

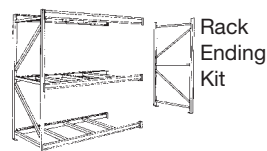

### Basic 3-Level Unit for Plywood \*

- 1 Upright Frame
- 3 Pair Standard Plywood Beams
- 3 Plywood Support Angles per pair of 72-1/2" Beams
- 4 Plywood Support Angles per pair of 96-1/2" Beams

ORDER RACK END KITS SEPARATELY. SEE BELOW.

\* NOTE: Plywood not included.

## Wide Span Shelving Units

Unit Height	Beam Width	30" Deep		36" Deep		48" Deep	
		Basic Unit Cat. No.	Rack End Kit Cat. No.	Basic Unit Cat. No.	Rack End Kit Cat. No.	Basic Unit Cat. No.	Rack End Kit Cat. No.
<b>Two Shelf Units with Steel Shelves</b>							
72"	60"	20351	20002C	20359	20003C	20375	20005C
	72"	20353	20002C	20361	20003C	20377	20005C
	84"	20355	20002C	20363	20003C	20379	20005C
	96"	20357	20002C	20365	20003C	20381	20005C
96"	60"	20383	20018C	20391	20019C	20407	20021C
	72"	20385	20018C	20393	20019C	20409	20021C
	84"	20387	20018C	20395	20019C	20411	20021C
	96"	20389	20018C	20397	20019C	20413	20021C
<b>Three Shelf Units with Steel Shelves</b>							
120"	60"	20415	20034C	20423	20035C	20439	20037C
	72"	20417	20034C	20425	20035C	20441	20037C
	84"	20419	20034C	20427	20035C	20443	20037C
	96"	20421	20034C	20429	20035C	20445	20037C
144"	60"	20447	20050C	20455	20051C	20471	20021C
	72"	20449	20050C	20457	20051C	20473	20021C
	84"	20451	20050C	20459	20051C	20475	20021C
	96"	20453	20050C	20461	20051C	20477	20021C
<b>Three Level Units for Plywood Shelves</b>							
120"	72-1/2"	-	-	-	-	20512	20037C
	96-1/2"	-	-	-	-	20514	20037C
144"	72-1/2"	-	-	-	-	20535	20053C
	96-1/2"	-	-	-	-	20537	20053C

## Wide Span Growth Diagram

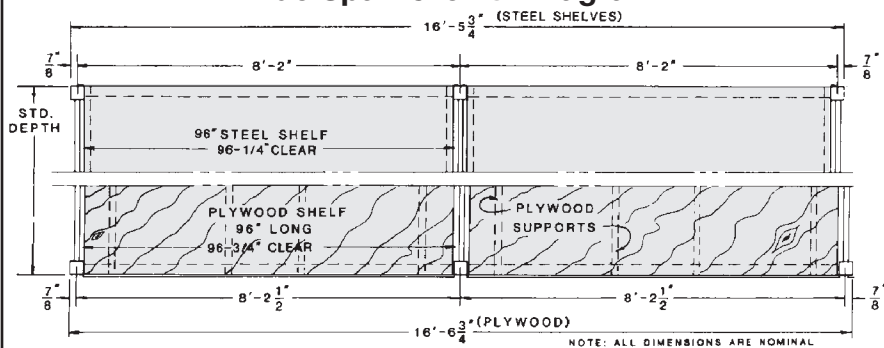

## Plywood used in lieu of Steel Shelves

Special beams and supports are used when plywood, pressed wood, particle board, oriented strand board or other composition type panels are used in place of steel shelves (these deck materials must be purchased separately).



All Wide Span Beams have a patented Beam Lock that secures the beam end to the upright post to retard accidental beam dislodging. An embossed nib on the beam end engages a slot on the side on the upright post, which

holds the beam end tight against the post (U. S. Patent No. 4,928,834). Can be disengaged with a mallet.

Two beam types are available: Standard Plywood Beams, and Heavy Duty Plywood Beams. Each is manufactured an extra 1/2" long to facilitate placement of full foot lengths of decking. Each uses a different type of front to back support for the decking material. Neither can be used in the same unit or bay with standard rigidity beams, because the lengths are different.

## Standard Plywood Beams

Standard Size panels may be used without trimming. This is accomplished by the step design which allows decking depths which match the upright depth. Capacities vary by beam length. Plywood Support Angles must be ordered separately. A full 48" x 96" deck will fit on a pair of 96-1/2" beams when 50" deep upright frames are used.

## Heavy Duty Plywood Beams

These beams can support a greater load than Standard Plywood Beams, and have a flush front facing the aisle. Requires the use of Beam Brace/Heavy Duty Plywood Supports which are ordered separately.

# Wide Span Shelving Components

## Side Shelf Supports

Heavy gauge steel angles which support steel shelves. Each support engages the upright frame at four points. One or more tangs stamped into the surface engages the reinforcing pan on the shelf bottom to prevent accidental dislodging of the shelf. One pair is required for each steel shelf.



Side Shelf Supports		
Unit Depth	Capacity Per Pair	Cat. No. Per Pair
24"	3600 lb	22024
30"	2900 lb	22030
36"	2400 lb	22036
42"	2100 lb	22042
48"	1800 lb	22048

## Rigid Wall Spacers

Assures that uniform spacing between upright and building wall is maintained. Includes hardware to fasten to frame.



Rigid Wall Spacers	
Unit Depth	Cat. No.
4"	5AR404
6"	5AR406
8"	5AR408
10"	5AR410

## Rigid Row Spacers

Used to space and join back-to-back units. Adds rigidity to double row applications. Includes hardware.



Rigid Row Spacers	
Unit Depth	Cat. No.
6"	5AR506
8"	5AR508
10"	5AR510
12"	5AR512

## Standard Plywood Beams

Designed to support 1/2" thick deck material flush with top of beam flange when used with the appropriate number of Plywood Support Angles which insert into slots in beam step. Overall height is 3-1/2". Beam step is 1-1/2" deep by 5/8" high. A 48" deep deck will fit between beams without trimming when a 48" deep upright frame is used.



Standard Plywood Beams		
Beam Width	Capacity Per Pair***	Cat. No. Per Pair
48-1/2"	2500 lb	20337
60-1/2"	2120 lb	20338
72-1/2"	1700 lb	20339
84-1/2"	1500 lb	20340
96-1/2"	1350 lb	20335

\*\*\*Capacity in pounds for evenly distributed loads.

## Heavy Duty Plywood Beams

A heavy duty beam designed for greater capacity when used with deck material. Deck material sits on beam step and is supported by the appropriate number of Beam Brace/ Heavy Duty Plywood Supports (order separately). Deck must be trimmed to 2" less depth than the depth of the upright frame.



Heavy Duty Plywood Beams can be used in the same unit or bay with Standard Plywood Beams. However, the decking material must be trimmed 2" for the heavy duty beams. Capacity in pounds for evenly distributed loads.

Heavy Duty Plywood Beams		
Beam Width	Capacity Per Pair	Cat. No. Per Pair
48-1/2"	2500 lb	210480
72-1/2"	2500 lb	210720
96-1/2"	2500 lb	210960

## Standard Plywood Support Angles

### Std Plywood Support Angles

Depth	Cat. No.
24"	20341C
30"	20330C
36"	20342C
42"	20332C
48"	20336C

Standard Plywood Support Angles fit into the slots in the beam step of Standard Plywood Beams. Order separately from beams. Order 2 per pair of 48-1/2" & 60-1/2" beams; 3 for 72-1/2" & 84-1/2" beams; 4 for 96-1/2" beams.



## Beam Brace / H. D. Plywood Support

This item fits easily into the inside of the beam opening and has two functions.

When Rigidity Beams are used as load bearing members, the Beam Braces are used to keep the beams from twisting.



### Beam Brace / H.D. Support

Depth	Capacity	Cat. No.
24"	1200 lb	202040C
30"	1100 lb	202050C
36"	900 lb	202060C
42"	700 lb	202070C
48"	500 lb	202080C
50"	500 lb	2P0050C

When used with Heavy Duty Plywood Beams they are become Plywood supports. Use a minimum of two supports per pair of beams. Use more if required by your load condition - see capacities in the table.

## Wide Span Base Closures

These base closures will close the space beneath a unit between the bottom Rigidity or Heavy Duty Plywood Beam at their lowest position, and the floor, or at the end of the unit between the lowest horizontal brace and the floor. They are supplied with tek screws for fastening.

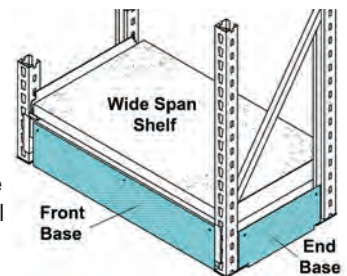

### Wide Span End Bases

Depth	Height	Cat. No.
18"	7-3/4"	202210H
24"	7-3/4"	202211H
30"	7-3/4"	202212H
36"	7-3/4"	202213H
42"	7-3/4"	202214H
48"	7-3/4"	202215H
50"	7-3/4"	202216H

### Wide Span Front Bases

Width	Height	Cat. No.
48"	6"	202200H
60"	6"	202201H
72"	6"	202202H
84"	6"	202203H
96"	6"	202204H

# Wide Span Shelving Components

## Upright Frames

Penco Wide Span Upright Frames are made from heavy gauge steel, MIG welded into one rigid assembly containing posts, diagonal and horizontal braces and foot plates for anchoring. There is no assembly required. Other sizes are available. See page 12 for anchors.

Posts are punched on the face to provide positive independent beam placement on 2" vertical centers. The posts are marked on 12" centers to facilitate placement of shelf levels. A slot on each side of the post accepts a nib on the end of each beam, to lock it in place.

Frames have a capacity of 7,500 pounds with a 1.92 safety factor where vertical beam spacing does not exceed 60". Footplates are punched for anchoring: see "Anchors" in the post section of Clipper shelving on page 12.



Upright Frames							
Unit Height	18" Deep Cat. No.	24" Deep Cat. No.	30" Deep Cat. No.	36" Deep Cat. No.	42" Deep Cat. No.	48" Deep Cat. No.	50" Deep Cat. No.*
72"	20000C	20001C	20002C	20003C	20004C	20005C	2P072C
84"	20008C	20009C	20010C	20011C	20012C	20013C	2P084C
96"	20016C	20017C	20018C	20019C	20020C	20021C	2P096C
120"	20032C	20033C	20034C	20035C	20036C	20037C	2P020C
144"	20048C	20049C	20050C	20051C	20052C	20053C	2P044C
168"	-	20065C	20066C	20067C	20068C	20069C	2P068C
192"	-	24001C	24002C	24003C	24004C	24005C	2P092C

\* 50" deep frame is for use with H.D. Plywood Beam. Allows use of standard 48" plywood deck without cutting for depth dimension.

## Rigidity Beams

Rigidity beams provide lateral stability when steel shelves are used. A minimum of 2 pairs of beams is required per unit. They are constructed of 3" high steel channels with return flanges, with a beam end connector welded to each end.

It is not necessary to place rigidity beams beneath each steel shelf. Rigidity Beams do not carry a load unless used to support wire decking. If used with wire decking, then use the Beam Brace/Heavy Duty Plywood Supports (shown on the previous page).



Rigidity Beams		
Unit Width	Capacity Per Pair**	Cat. No. Per Pair
48"	2500 lb	20315
60"	2140 lb	20316
72"	1780 lb	20317
84"	1580 lb	20318
96"	1340 lb	20319

\*\* Capacity per pair in pounds for evenly distributed load when used as load bearing members using Beam Braces/H.D. Plywood Supports as follows: 60" x 72" length, 1 Beam Brace; 84" x 96" length, 2 Beam Braces.

## Steel Shelves

Penco Steel Wide Span Shelves are the ultimate in providing a smooth, safe surface for storing a wide variety of items. They are 1-3/4" high and feature double flanges at front and rear edges with a full width reinforcing pan welded to the center of the bottom.

Each shelf requires a pair of Side Shelf Supports, which must be ordered separately. For 36", 42" and 48" depths, the appropriate number of 18" and 24" deep shelves are provided, and are installed together on the Side Shelf Supports to achieve the stated depth.

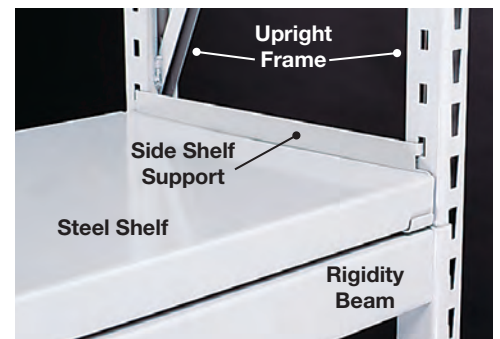

## Tire Rack Beams

Penco can supply special beams for installation on the aisle side that are slanted to accept passenger tires, while standard Rigidity Beams are used at the rear. Contact your Penco representative for more information on Tire Rack Units.

Steel Shelves										
Unit Depth	48" Wide		60" Wide		72" Wide		84" Wide		96" Wide	
	Cat. No.	Capacity *	Cat. No.	Capacity *	Cat. No.	Capacity *	Cat. No.	Capacity *	Cat. No.	Capacity *
18"	22418C	1200 lb	22518C	1200 lb	22618C	1000 lb	22718C	800 lb	22818C	600 lb
24"	22424C	1500 lb	22524C	1200 lb	22624C	1000 lb	22724C	800 lb	22824C	600 lb
30"	22430C	2300 lb	22530C	1800 lb	22630C	1500 lb	22730C	1200 lb	22830C	900 lb
36"	22436	2400 lb	22536	2400 lb	22636	2000 lb	22736	1600 lb	22836	1200 lb
42"	22442	2000 lb	22542	2000 lb	22642	2000 lb	22742	1600 lb	22842	1200 lb
48"	22448	1800 lb	22548	1800 lb	22648	1800 lb	22748	1600 lb	22848	1200 lb

\* NOTE: Shelf capacities in pounds, evenly distributed.

# Wide Span Specifications

## COMPONENTS

**Upright Frames:** Penco Wide Span Upright Frames are made from heavy gauge steel, MIG welded into one rigid assembly containing posts, diagonal and horizontal braces and foot plates. There is no assembly required. Many sizes are available. Posts are punched on the face to provide positive independent beam placement on 2" vertical centers. The posts are marked on 12" centers to facilitate placement of shelf levels. A slot on each side of the post accepts a nib on the end of each beam, to lock it in place. Frames have a capacity of 7,500 pounds with a 1.92 safety factor where vertical beam spacing does not exceed 60".

**Rigidity Beams:** Rigidity beams provide lateral stability for the shelving; a minimum of two pairs of beams is required per unit. They are constructed of 3" high steel channels with return flanges and a beam end connector welded to each end. Beams are supplied in even foot lengths from 4' through 8'. Clearance between upright frames is 1/4" more than stated beam size. If the beams are being used as load bearing members, then Beam Braces are required. All Wide Span Beams have a patented Beam Lock that secures the beam end to the upright post to retard accidental beam dislodging. An embossed nib on the beam end engages a slot on the side on the upright post, which holds the beam end tight against the post (U. S. Patent No. 4,928,834). Can be disengaged with a mallet. It is normally not necessary to place rigidity beams beneath each steel shelf.

**Steel Shelves:** Penco Steel Wide Span Shelves are the ultimate in providing a smooth, safe surface for storing a wide variety of items. They are 1-3/4" high and feature double flanges at front and rear edges with a full width reinforcing pan welded to the center of the bottom. Each shelf requires a pair of Side Shelf Supports, which must be ordered separately. For 36", 42" and 48" depths, the appropriate number of 18" and 24" deep shelves are provided, and are installed together on the Side Shelf Supports to achieve the stated depth.

**Side Shelf Supports:** Heavy gauge steel angles which support steel shelves. Each support engages the upright frame at four points. One or more tangs stamped into the surface engages the reinforcing pan on the shelf bottom to prevent accidental dislodging of the shelf. One pair is required for each steel shelf.

**Rigid Wall Brackets:** Used to fasten upright frames to the wall for sturdy single row applications. Includes hardware to fasten to frame.

**Rigid Row Spacers:** Used to space and join back-to-back shelving units. Adds rigidity to double row applications. Includes hardware.

**PLYWOOD USED IN LIEU OF STEEL SHELVES:** Special beams and supports are used when plywood, pressed wood, particle board, oriented strand board or other composition type panels are used in place of steel shelves (these deck materials must be purchased separately). Two beam types are available: Standard Plywood Beams, and Heavy Duty Plywood Beams. Each is manufactured an extra 1/2" long to facilitate placement of full foot lengths of decking. Each uses a different type of front to back support for the decking material. Neither can be used in the same unit or bay with standard rigidity beams, because the lengths are different.

**Standard Plywood Beams:** Designed to support 1/2" thick deck material flush with top of beam flange when used with the appropriate number of Plywood Support Angles (ordered separately) which insert into slots in beam step. Overall height is 3-1/2". Beam step is 1-1/2" deep by 5/8" high. A 48" deep deck will fit between beams without trimming when a 48" deep upright frame is used.

**Heavy Duty Plywood Beams:** These beams can support a greater load than Standard Plywood Beams, and have a flush front facing the aisle. Requires the use of Beam Brace/Heavy Duty Plywood Supports which are ordered separately. A full 48" x 96" deck will fit on a pair of 96-1/2" beams when 50" deep upright frames are used. Heavy Duty Plywood Beams can be used in the same unit or bay with Standard Plywood Beams, however the depth of the decking material must be trimmed for the heavy duty beams (i.e. deck must be trimmed to 2" less depth than the depth of the upright frame.)

**Standard Plywood Support Angles:** Standard Plywood Support Angles fit into the slots in the beam step of Standard Plywood Beams. Order separately from beams. Order two per pair of 48-1/2" & 60-1/2" beams; three for 72-1/2" & 84-1/2" beams; four for 96-1/2" beams.

**Beam Brace/Heavy Duty Plywood Support:** This item fits easily into the inside of the beam opening and has two functions: A) When Rigidity Beams are used as load bearing members, the Beam Braces are used to keep the beams from twisting; B) When used with Heavy Duty Plywood Beams they are used as Plywood supports. Use a minimum of two supports per pair of beams. Use more if required by your load condition.

PENCO RESERVES THE RIGHT TO VARY SPECIFICATIONS CONSISTENT WITH A POLICY OF CONTINUOUS PRODUCT IMPROVEMENT.



# RivetRite® Shelving

## Introduction

### RivetRite Universal Shelf Framing System

We call RivetRite the Universal Shelf Framing System because so many storage requirements can be met with only a few simple components. RivetRite is engineered to provide safe, economical storage of virtually any type of hand-loaded material. Structural integrity is ensured by a rigid boltless connection between beams and posts.

RivetRite offers the following to help solve your storage problems:

- Economical — your shelving dollar goes a long way
- Easy assembly without special tools - all you need is a rubber mallet to assemble most units
- Access to contents from all four sides - no braces to get in the way
- Shelves adjustable on 1-1/2" centers- allows you to custom design unit to fit your load size
- A variety of beams to accommodate a wide range of loads - you buy the capacity you need
- Finished in durable powder coat enamel - baked on for permanence. Available in 24 colors
- Order by pre-configured UNITS (pages 25-30) or by individual components (pages 32-36)



### Components

RivetRite shelving is comprised of 4 types of posts for the vertical members and various horizontal support members. In this way it is possible to order by components to tailor the shelving to the items to be stored.

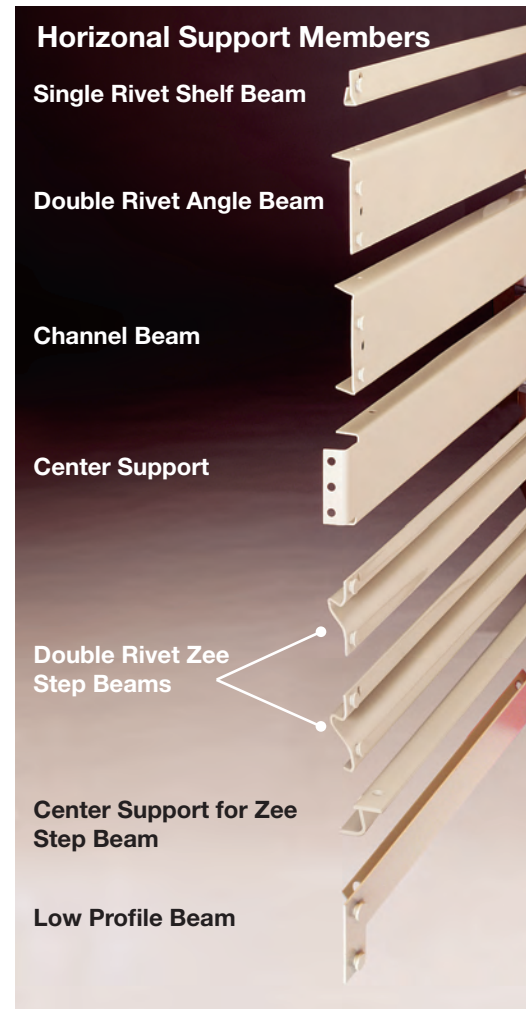

(Double Rivet Beams are ALWAYS used for the full perimeter at the TOP and BOTTOM of ALL Units)

# RivetRite® Shelving

## Building Your RivetRite® Units

### Single Rivet High Density Units

Single Rivet high density shelving uses single rivet beams on intermediate levels, and double rivet beams at the top and bottom for rigidity. For units up to 48" wide.

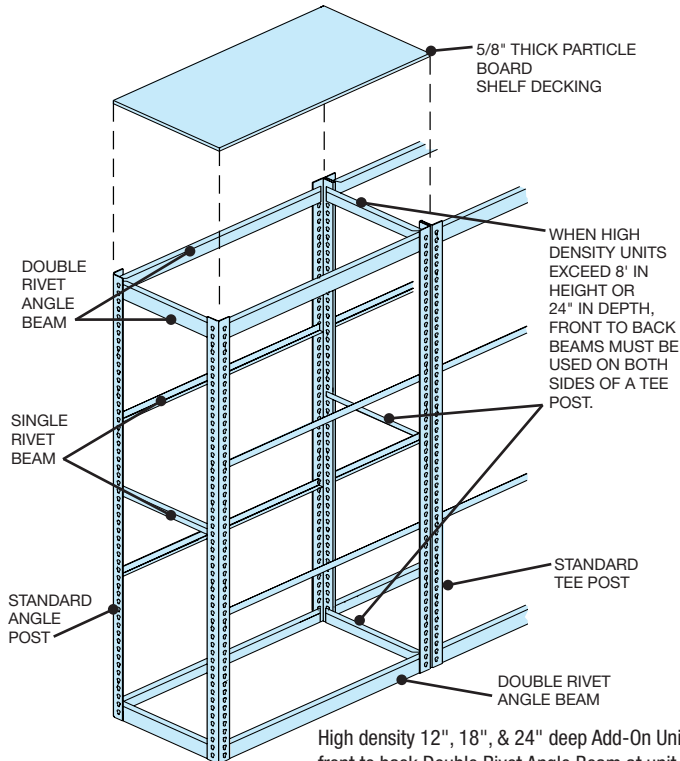

High density 12", 18", & 24" deep Add-On Units require only one front to back Double Rivet Angle Beam at unit top and bottom and one Single Rivet Shelf Beam for front to back at unit center.

### Double Rivet Bulky Storage Units

Below is an illustration of a typical Double Rivet unit - designed for spans of 48" to 96" wide.

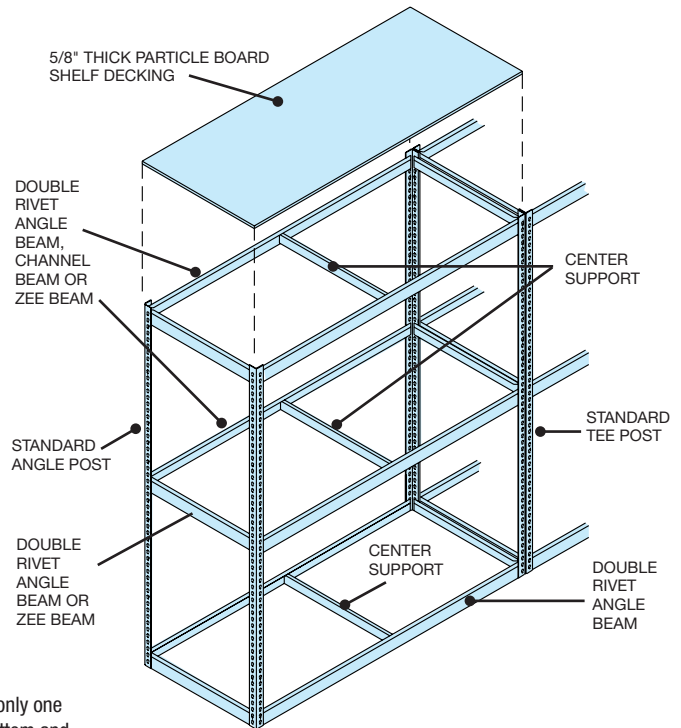

### Single Rivet Units

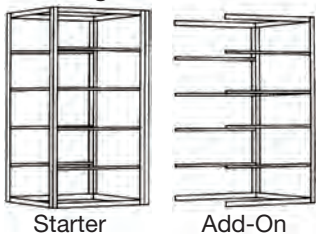

### Starters and Adders



### Double Rivet Units

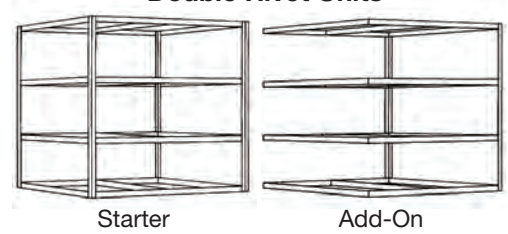

Starter and Add-On units are combined to form economical rows of shelving. Each Add-On unit includes a pair of tee posts which are used in common between units. This reduces assembly time and the number of parts required. Begin each row with two angle posts from the starter unit and join the desired number of add-on units to complete the row. Finish the last unit with a pair of angle posts from the starter unit. All dimensions in the tables are in inches and are subject to change without notice.

### Steps for Selecting Your RivetRite® Units

1. Review the catalog and decide what type of unit will meet your requirement.
2. Determine the shelf size desired and select the capacity needed. Note the capacity shown is for the steel structure only.
3. Next determine the type of shelf deck material and calculate the quantity. Note that none of the unit catalog numbers include decking. Particle Board decking available from Penco is unfinished. Flat wire decking is plated.
4. All starter units are furnished with four Angle Posts. Add-on units have two intermediate Tee Posts. When assembling units, always put the Angle Posts at the extreme ends of the shelving row. Note that shelving growth will always occur; see Growth Chart on pg. 38.
5. When ordering piece parts from the Component Parts pages of the catalog, contact your Penco representative for guidance on piece part capacities and product application to insure structural integrity.

**RivetRite®**

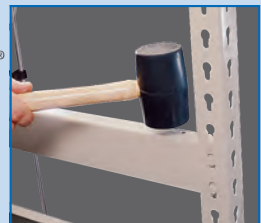

# RivetRite® Shelving

## Single Rivet Units: Up to 48" Wide



### Single Rivet High Density Units

Single Rivet High Density shelving uses single rivet beams on intermediate levels, and double rivet beams on all four sides at the top and bottom for rigidity. For units up to 48" wide.

Starter and add-on units are combined to form economical rows of shelving. Each add-on unit includes a pair of tee posts which are used in common between units. This reduces assembly time and the number of parts required. Begin each row with two angle posts from the starter unit and join the desired number of add-on units to complete the row. Finish the last unit with a pair of angle posts from the starter unit.

All intermediate shelves on units that exceed 24" deep utilize single rivet beams for front to back shelf deck support.

Units 12", 18" and 24" deep include one pair of single rivet beams for intermediate use front to back.

- High Density Single Rivet Shelf Beams provide maximum space between shelf levels
- Common tee posts between starter and add-on unit
- Shelf levels adjust on 1-1/2" centers
- Fast easy assembly
- No special tools needed
- Optional heavy duty single rivet shelf beams available for added capacity



Starter



Add-On



### Single Rivet High Density Units (84" High)

Unit Width	Shelf Depth	Shelf Capacity*	5 Shelf Cat. No.	6 Shelf Cat. No.	7 Shelf Cat. No.	8 Shelf Cat. No.
36" Starter Units	12"	350	461315	461316	461317	461318
	18"	350	461325	461326	461327	461328
	24"	350	461335	461336	461337	461338
	36"	350	461345	461346	461347	461348
36" Add-On Units	12"	350	462355	462356	462357	462358
	18"	350	462365	462366	462367	462368
	24"	350	462375	462376	462377	462378
	36"	350	462385	462386	462387	462388
48" Starter Units	12"	250	461415	461416	461417	461418
	18"	250	461425	461426	461427	461428
	24"	250	461435	461436	461437	461438
	36"	250	461445	461446	461447	461448
48" Add-On Units	12"	250	462455	462456	462457	462458
	18"	250	462465	462466	462467	462468
	24"	250	462475	462476	462477	462478
	36"	250	462485	462486	462487	462488

\* Capacities shown are for the steel support beams, not the shelf deck material. For higher support beam capacity, see "RivetRite Components". Capacities are in pounds for evenly distributed loads. All unit catalog numbers include metal framing only. Shelf deck material must be ordered separately.

# RivetRite® Shelving

## Double Rivet Units: Up to 96" Wide



### Double Rivet Units

Double Rivet Units use the same posts and top and bottom perimeter beams as single rivet units, however all intermediate beams are of double rivet construction. Units are either 84" or 120" high. Some units have center supports for higher capacity and some units have channel beams in place of angle beams for heavier loads.

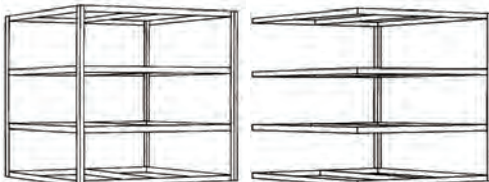

Starter

Add-On



### Double Rivet Bulky Storage Units (With 4 Shelves - 84" High)

Unit	Beam	Shelf	WITHOUT Center Support			WITH Center Support		
			Shelf Capacity*	Starter Cat. No.	Add-On Cat. No.	Shelf Capacity*	Starter Cat. No.	Add-On Cat. No.
48" Wide Units	Heavy Duty Angle	18"	750	46001H	46006H	1400	46W01H	46W06H
		24"	750	46002H	46007H	1400	46W02H	46W07H
		30"	750	46003H	46008H	1310	46W03H	46W08H
		36"	750	46004H	46009H	1220	46W04H	46W09H
		48"	750	46005H	46010H	1125	46W05H	46W10H
60" Wide Units	Heavy Duty Angle	18"	600	46011H	46016H	1200	46W11H	46W16H
		24"	600	46012H	46017H	1200	46W12H	46W17H
		30"	600	46013H	46018H	1200	46W13H	46W18H
		36"	600	46014H	46019H	1200	46W14H	46W19H
		48"	600	46015H	46020H	1200	46W15H	46W20H
	Channel	18"	-	-	-	2240 (1)	46W01C	46W06C
		24"	-	-	-	2240 (1)	46W02C	46W07C
		30"	-	-	-	2240 (1)	46W03C	46W08C
		36"	-	-	-	2240 (1)	46W04C	46W09C
		48"	-	-	-	2240 (1)	46W05C	46W10C
72" Wide Units	Heavy Duty Angle	18"	500	46021H	46026H	1000	46W21H	46W26H
		24"	500	46022H	46027H	1000	46W22H	46W27H
		30"	500	46023H	46028H	1000	46W23H	46W28H
		36"	500	46024H	46029H	1000	46W24H	46W29H
		48"	500	46025H	46030H	1000	46W25H	46W30H
	Channel	18"	-	-	-	1850	46W11C	46W16C
		24"	-	-	-	1850	46W12C	46W17C
		30"	-	-	-	1850	46W13C	46W18C
		36"	-	-	-	1850	46W14C	46W19C
		48"	-	-	-	1850	46W15C	46W20C
96" Wide Units	Heavy Duty Angle	18"	-	-	-	620	46W31H	46W36H
		24"	-	-	-	620	46W32H	46W37H
		30"	-	-	-	620	46W33H	46W38H
		36"	-	-	-	620	46W34H	46W39H
		48"	-	-	-	620	46W35H	46W40H
	Channel	18"	-	-	-	1400	46W21C	46W26C
		24"	-	-	-	1400	46W22C	46W27C
		30"	-	-	-	1400	46W23C	46W28C
		36"	-	-	-	1400	46W24C	46W29C
		48"	-	-	-	1400	46W25C	46W30C

### Double Rivet Bulky Storage Units (With 5 Shelves - 120" High)

Unit	Beam	Shelf	WITHOUT Center Support			WITH Center Support		
			Shelf Capacity*	Starter Cat. No.	Add-On Cat. No.	Shelf Capacity*	Starter Cat. No.	Add-On Cat. No.
72" Wide Units	Heavy Duty Angle	30"	500	46041H	46044H	1000	46W41H	46W44H
		36"	500	46042H	46045H	1000	46W42H	46W45H
		48"	500	46043H	46046H	1000	46W43H	46W46H
	Channel	30"	-	-	-	1850 (2)	46W31C	46W34C
		36"	-	-	-	1850 (2)	46W32C	46W35C
		48"	-	-	-	1850 (2)	46W33C	46W36C
96" Wide Units	Heavy Duty Angle	30"	-	-	-	620	46W47H	46W50H
		36"	-	-	-	620	46W48H	46W51H
		48"	-	-	-	620	46W49H	46W52H
	Channel	30"	-	-	-	1400	46W37C	46W40C
		36"	-	-	-	1400	46W38C	46W41C
		48"	-	-	-	1400	46W39C	46W42C

\* Capacities shown are for the steel support beams, not the shelf deck material. For higher support beam capacity, see "RivetRite Components". Capacities are in pounds for evenly distributed loads. All unit catalog numbers include metal framing only. Shelf deck material must be ordered separately. All Double Rivet Bulky Storage Units with Channel Beams are furnished with Heavy Duty Double Rivet Angle Beams (left to right) at the bottom level.  
 (1) - Max. Average Shelf Load 2000# per shelf. (2) - Max. Shelf Load 1490# per shelf.

# RivetRite® Shelving

## Record Storage Shelving



**80 Box Unit with Decking**  
Cat. No. 46604A  
(Order decking separately)



(Boxes are not included)

**80 Box Unit with Steel Box Supports**  
Cat. No. 46708A

### Keep Your Records Organized!

- Assembles without special tools
- Records can be retrieved from both sides
- Units can be added as needed
- Two shelf types available: particle board and steel box supports (see particle board sizes on page xx)
- 42" wide units hold 3 boxes across
- 69" wide units hold 5 boxes across
- Various unit heights are available



### Record Storage Units

RivetRite Record Storage Units aid in records management by providing an organized solution for high density archive storage applications.

Two types of units are available; one that uses particle board (or another solid shelf deck material) and an all-steel unit with specially designed box supports.

Add-on units utilize a common Tee Post between units to save time during assembly.

### Record Storage Box Supports

Steel Box Supports are an alternative to solid shelf decks.

They allow air to circulate around the entire box, helping to reduce moisture and musty smells. They align with holes pre-punched in the special double rivet beams and are secured with nylon button fasteners. They are included with the units shown at the bottom of the table to the right.

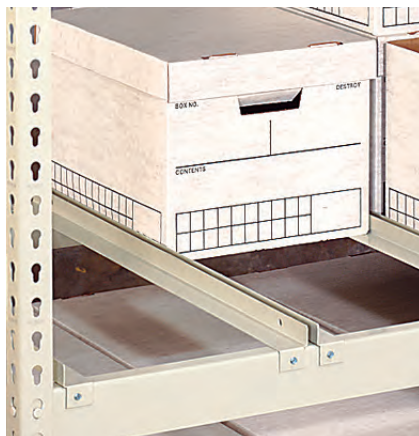

### Record Storage Units

#### For Use With Decking (order deck material separately)

Unit Width	Unit Depth	Unit Height	No. of Shelves	No. of Boxes*	Starter Cat. No.	Add-On Cat. No.
42"	15"	84"	4	24	46601A	46613A
42"	30"	84"	4	48	46602A	46614A
69"	15"	84"	4	40	46603A	46615A
69"	30"	84"	4	80	46604A	46616A
42"	15"	108"	5	30	46605A	46617A
42"	30"	108"	5	60	46606A	46618A
69"	15"	108"	5	50	46607A	46619A
69"	30"	108"	5	100	46608A	46620A
69"	15"	168"	7	70	46609A	46621A
69"	30"	168"	7	140	46610A	46622A
69"	15"	192"	8	80	46611A	46623A
69"	30"	192"	8	160	46612A	46624A

#### With Box Supports

Unit Width	Unit Depth	Unit Height	No. of Shelves	No. of Boxes*	Starter Cat. No.	Add-On Cat. No.
42"	15"	60"	3	18	46701A	46709A
42"	30"	60"	3	36	46702A	46710A
69"	15"	60"	3	30	46703A	46711A
69"	30"	60"	3	60	46704A	46712A
42"	15"	84"	4	24	46705A	46713A
42"	30"	84"	4	48	46706A	46714A
69"	15"	84"	4	40	46707A	46715A
69"	30"	84"	4	80	46708A	46716A

\* All unit box capacities are based on a standard archive box size of approximately 12-1/2" wide x 16-1/2" deep x 10-1/2" high.

# RivetRite® Shelving

## Inventory Systems

### Tire Storage Rack

Penco RivetRite® Tire Racks provide for the neat organized storage of standard automobile or light truck tires. Specially designed beams with a 30° flange on the top securely cradle the tires. Available in Single-Row, (12" deep units with 9" Wall Ties) and Double-Row, (two 12" deep units separated by 18" Double Row Spacers). Unit depth shown includes wall ties/row spacers. Deeper units are available to accommodate larger SUV tires.

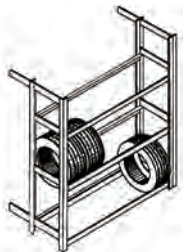

Single Row Starter

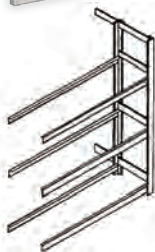

Single Row Add-On

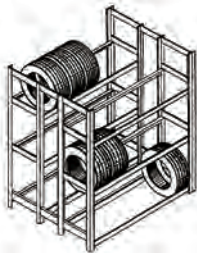

Double Row Starter

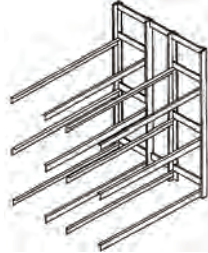

Double Row Add-On

### Passenger Tire Storage Rack

#### Single Row

Unit Width	Unit Depth	Unit Height	No. of Levels	Tire Capacity*	Starter Cat. No.	Add-On Cat. No.
60"	21"	84"	3	24	46351T	46451T
60"	21"	120"	4	32	46352T	46452T
60"	21"	144"	5	40	46353T	46453T
60"	21"	192"	6	48	46354T**	46454T**

#### Double Row

Unit Width	Unit Depth	Unit Height	No. of Levels	Tire Capacity*	Starter Cat. No.	Add-On Cat. No.
60"	42"	84"	3	48	46355T	46455T
60"	42"	120"	4	64	46356T	46456T
60"	42"	144"	5	80	46357T	46457T
60"	42"	192"	6	96	46358T**	46458T**

NOTE: Tire rack capacities are based on average passenger tire sizes.

\*\* Supplied with Heavy Duty Posts.

### Muffler Storage Unit

Provides sturdy storage for mufflers or other inventory items. All double rivet beam construction. Available in 48" and 96" widths in both starter and add-on configurations. Particle board must be ordered separately – see page 40.



### Muffler Storage Units

Unit Width	Unit Depth	Unit Height	Starter Cat. No.	Add-On Cat. No.
48"	36"	84"	46801M	46803M
96"	36"	84"	46802M	46804M

### Hanging Tailpipe Rack

Designed specifically for the storage of automotive and light truck tailpipes. Assembles in minutes without special tools. Stored items are visible and easily accessible. Hanging hooks are not provided by Penco.



### Hanging Tailpipe Rack

Clear Span	Unit Depth	Unit Height	Cat. No.
48"	18"	120"	46901P
96"	18"	120"	46902P

# RivetRite® Shelving

## Inventory Cart / Installation Photos

### Inventory Carts

The Penco Inventory Cart transports supplies, orders, merchandise, tools or files from point to point with ease. The cart is easy to assemble and additional shelves can be easily added.

Shelves can be adjusted to fit a wide variety of load sizes, providing greater flexibility than traditional carts. The cart is available in 2 heights, 48" and 60", each with a choice of 3 lengths.

Available with particle board deck, white melamine deck or no deck. See sizes and catalog numbers in the table, including extra levels of shelf beams with deck included.



#### Inventory Carts

Shelf Length	Shelf Width	Unit Height	Particle Board Deck	Melamine Deck	No Decking
<b>48" Cart with Three Shelves</b>					
36"	24"	48"	35076C	35080C	35095C
48"	24"	48"	35077C	35081C	35096C
60"	24"	48"	35078C	35082C	35097C
<b>60" Cart with Four Shelves</b>					
36"	24"	60"	35074C	35083C	35092C
48"	24"	60"	35073C	35084C	35093C
60"	24"	60"	35075C	35085C	35094C
<b>Shelf Kits for Additional Levels (Each Kit = 4 beams &amp; 1 deck)</b>					
36"	24"	1"	35086C	35089C	-
48"	24"	1"	35087C	35090C	-
60"	24"	3-5/8"	35088C	35091C	-



Overall height of the 48" cart is 54" with base and wheels. Overall height of the 60" cart is 66" with base and wheels. All 36" and 48" wide carts use Single Rivet Beams on intermediate levels.

All 60" wide carts use Double Rivet Beams on intermediate levels.



Left: RivetRite used as retail display shelves.

Below: RivetRite for hanging garment storage.

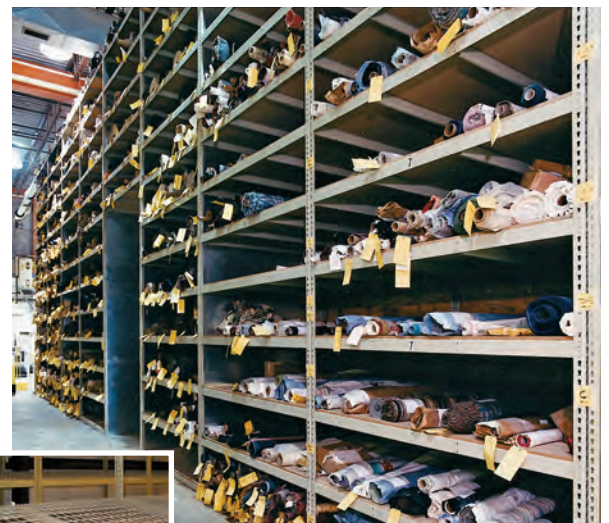

Above: RivetRite storing for rolled bolts of fabric.



Left: RivetRite used with optional wire shelf decking.

# RivetRite® Shelving

## Two-Level Storage

The structural integrity of RivetRite lends itself to the construction of two-level storage facilities for applications where maximum utilization of overhead space is required. Expanding in an upward direction instead of outward keeps your personnel in closer proximity to each other and stored material, for more efficient operation.

Using standard components for support, economical units may be constructed with an open "deck-over" upper level, or additional shelving. In either case, savings are realized because:

- You virtually double the amount of storage space in a given floor area
- You utilize existing heat and air conditioning within the building

Various components in addition to RivetRite may be used to create a multi-level structure, and these are also used for multi-level structures for other types of shelving and work platforms manufactured by our sister company, Schmidt Structural Products.

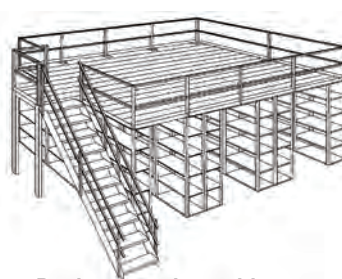

Deck-over unit provides an unrestricted work area.

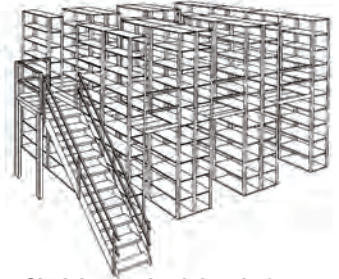

Shelving on both levels for high density storage.

**Stairs:** All applications involving stairs are reviewed individually and designed to meet or exceed local, state and federal codes in effect at the location where the stairs are to be installed.

Side frames are made from heavy duty MC10 structural steel. Handrails and inner handrails are welded in place, and all parts are finished with an attractive, durable powder coat finish.

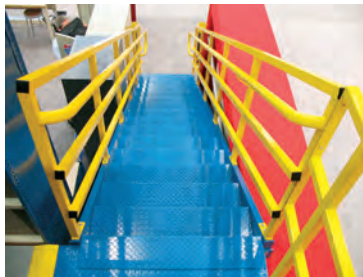

**A. - Handrail & Kickplate:** Penco handrail is designed for either two or three rails, depending on code requirements. It has welded tubular steel uprights and cross-rails with heavy gauge kickplate. All are finished with an attractive, durable powder coat finish.

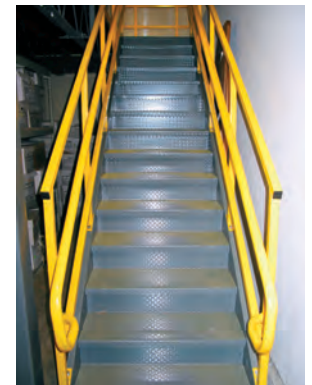
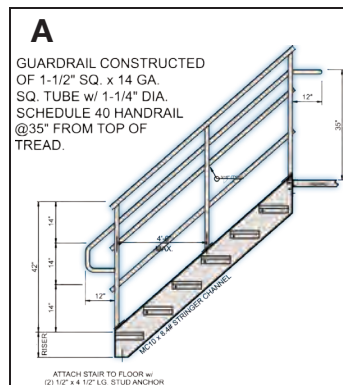

**B. - Landings:** Landings for stairs feature a heavy duty 1/8" diamond plate decking, handrail and kickplate on two sides and four column supports.

Two-column pedestal supported units are also available. Special sizes and baluster handrails are also available. All are finished with an attractive, durable powder coat finish.

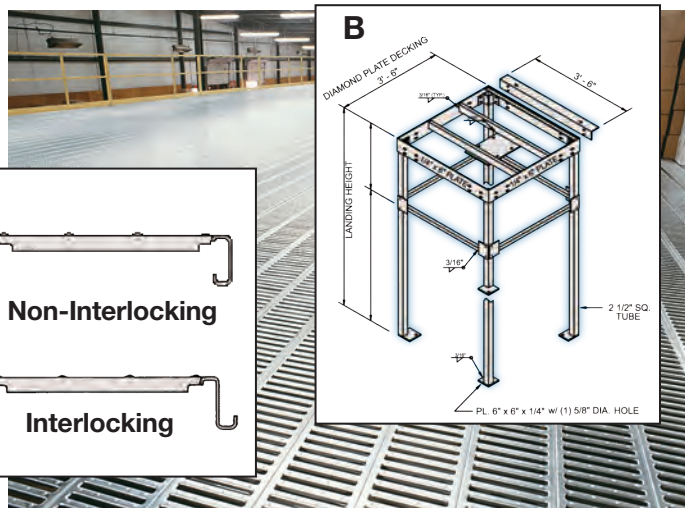

**C. - Grating:** Penco Channel-Lock Safety Grating provides a non-corrosive and sure-footed ventilated work platform surface. Manufactured from 16 gauge high strength hot dip galvanized steel, the design allows it to interlock for added strength. (Ordering info on page 34.)

Other functional and popular work platform decking includes bar grating, roof deck and wood, or poly-coated non-skid surfaces. Your Penco representative can assist you in selecting the work surface that works best in your multi-level storage application.

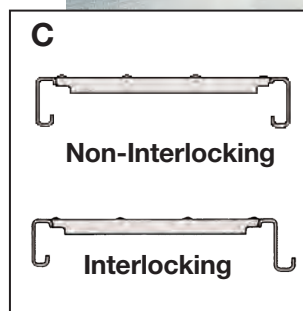



# RivetRite® Shelving Components

## Posts

### Angle Posts

#### Standard Duty Angle:

1-1/2" x 1-1/2". Used as upright post for standard RivetRite units. All Angle Posts allow for beam adjustments on 1-1/2" centers.



#### Heavy Duty Angle:

1-7/8" x 1-7/8". When greater capacity and stability are essential, the heavy duty angle post is the proper choice. Ideally suited for two level shelving, storage deck and high rise shelving applications.

### Tee Posts

#### Standard Duty Tee:

3" x 1-1/2". Included with standard duty add-on units to function as a common post between the starter unit and adjoining units. All Tee Posts allow for beam adjustment on 1-1/2" centers.



#### Heavy Duty Tee:

3-3/4" x 1-7/8". Used in the same way as the standard tee, when increased load capacities are required.

RivetRite® Posts			
Item Desc.	Size	Standard Cat. No.	Hvy Duty Cat. No.
Angle Posts	36"	46AS03C	-
	48"	46AS04C	-
	60"	46AS05C	-
	72"	46AS06C	-
	84"	46AS07C	-
	96"	46AS08C	46AH08C
	108"	46AS09C	46AH09C
	120"	46AS10C	46AH10C
	144"	46AS12C	46AH12C
	168"	-	46AH14C
Tee Posts	192"	-	46AH16C
	216"	-	46AH18C
	36"	46TS03C	-
	48"	46TS04C	-
	60"	46TS05C	-
	72"	46TS06C	-
	84"	46TS07C	46TH07C
	96"	46TS08C	46TH08C
	108"	46TS09C	46TH09C
	120"	46TS10C	46TH10C
	144"	46TS12C	46TH12C
	168"	-	46TH14C
	192"	-	46TH16C
216"	-	46TH18C	

## Beams

### Single Rivet Shelf Beams

#### Standard Duty Single Rivet "SS":

Primarily used as an intermediate shelf support when maximum vertical space between levels is needed. Furnished as standard on High Density Shelving units.

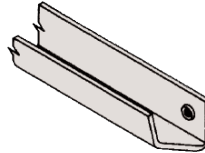

#### Heavy Duty Single Rivet "HS":

Manufactured to provide greater capacity with very little loss of usable vertical space between shelves.

### Double Rivet Angle Beams

#### Standard Duty "SB":

Used to establish unit stability and to provide shelf support on all four sides.

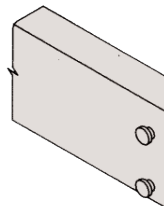

#### Heavy Duty "HB":

Provides stability and increased load capacity in the longer lengths.

RivetRite® Beams				
Item Desc.	Size	Standard Cat. No.	Hvy Duty Cat. No.	
Single Rivet Shelf Beams	12"	46SS12C	-	
	15"	46SS15C	-	
	18"	46SS18C	-	
	24"	46SS24C	-	
	30"	46SS30C	-	
"SS" & "HS"	36"	46SS36C	46HS36C*	
	42"	46SS42C	46HS42C	
	48"	46SS48C	46HS48C**	
	Double Rivet Angle Beams	12"	46SB12C	-
		15"	46SB15C	-
		18"	46SB18C	-
24"		46SB24C	-	
30"		46SB30C	-	
32"		46SB32C	-	
36"		46SB36C	-	
42"		46AB42C***	-	
42"		46SB42C	-	
"SB" & "HB"		48"	-	46HB48C
	60"	-	46HB60C	
	69"	-	46AB69C***	
	69"	-	46HB69C	
	72"	-	46HB72C	
	84"	-	46HB84C	
	96"	-	46HB96C	

\* Heavy Duty 36" support beam capacity is 600 lb. per pair.  
 \*\* Heavy Duty 48" support beam capacity is 500 lb. per pair.  
 \*\*\* Punched for Box Supports

### Double Rivet Channel Beams "CB":

3" x 1". Channel is designed to provide maximum left to right stability and higher capacity than standard or heavy duty beams. Cannot be used at floor level. The top flange has holes for fastening decking.

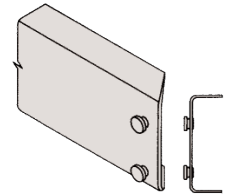

### Double Rivet Zee Step Beams:

Reduced profile increases vertical clearance by 1-1/4"

between shelf levels when used in place of Double Rivet Angle Beams.

Protects decking edges. When used as the bottom shelf on Single Rivet Units, clear space between the bottom and first shelf is increased by 1-1/4".

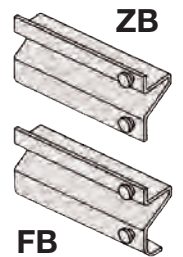

### Tire Rack Beams "TB":

2-3/4" high - For left to right shelf support of tires. 30 degree angle on supporting edge of tire rack beam.

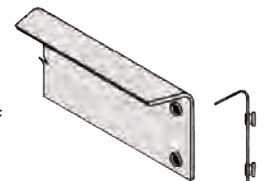

Beams, Continued		
Item Desc.	Size	Standard Cat. No.
Double Rivet Channel Beams "CB"	60"	46CB60C
	69"	46CB69C
	72"	46CB72C
	84"	46CB84C
	96"	46CB96C
Double Rivet Zee Step Beams "ZB" & "FB"	12"	46ZB12C
	15"	46ZB15C
	18"	46ZB18C
	24"	46ZB24C
	30"	46ZB30C
	32"	46ZB32C
	36"	46ZB36C
	42"	46ZB42C
	48"	46ZB48C
	60"	46ZB60C
69"	46FB69C	
72"	46FB72C	
Tire Rack Beams "TB"	48"	46TB48C
	60"	46TB60C

# RivetRite® Shelving Components

## Double Rivet Low-Profile Beams:

Available in lengths up to 48", this beam has the smallest vertical profile of all double rivet beams.



## Center Support:

Used with double rivet beams to provide front-to-rear support for shelf deck and provides added stability to beams. Hardware included.

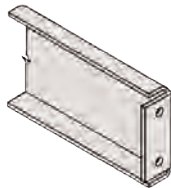

## Decking Support for Zee Step Beam:

Used with Zee Step Beams for front to back decking support.

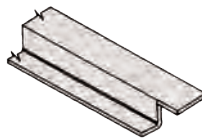

## Post Splice:

1-3/8" x 1-3/8". Used to extend posts. Order one per angle post. Order two per tee post. Note: installs on the outside of the post.



## Beams, Center Supports & Splice

Item Desc.	Size	Standard Cat. No.
Low-Profile Beams	12"	46DB12C
	15"	46DB15C
	18"	46DB18C
	24"	46DB24C
	30"	46DB30C
	32"	46DB32C
	36"	46DB36C
	42"	46DB42C
Center Support with Hardware	48"	46DB48C
	12"	46CS12
	15"	46CS15
	18"	46CS18
	24"	46CS24
	30"	46CS30
	32"	46CS32
	36"	46CS36
Decking Support for Zee Step Beams	42"	46CS42
	48"	46CS48
	24"	46ZS24C
	30"	46ZS30C
	32"	46ZS32C
	36"	46ZS36C
Post Splice	42"	46ZS42C
	48"	46ZS48C
1-3/8" x 1-3/8"	46PS0H	

## Wall Tie:

Used to secure units to wall and provide space between wall and attached units. Hardware is not included.

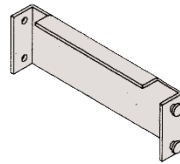

## Double Row and Top Ties:

Designed to space back-to-back units and to top-tie rows across aisles for additional stability.



## Concrete Anchors:

Used to secure posts to the floor (foot plates are used). Available in 2 lengths; the 2-1/4" length is sufficient for most usage, but areas with a high seismic rating may require the 3-3/4" length.



## Flue Spacing Components:

To allow nominal 6" spacing between RivetRite units to satisfy NFPA (National Fire Protection Agency) safety recommendations.

The component pictured is for use with either RivetRite Tee or Angle Posts in a back-to-back condition. (No. 46RT06)

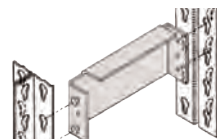

This component is for use with RivetRite Angle or Tee Posts positioned side by side. (No. 46AX153)

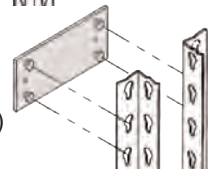

## Foot Plate & Shim:

Foot Plate includes hardware, for anchoring angle and tee posts to the floor. NOTE: foot plate cannot be used if there is a double rivet channel beam at the lowest point.

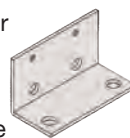

Shim (14 ga.) is for placement beneath footplate if floor is uneven.



## Ties and Anchors

Description	Size	Std. Cat. No.
Wall Tie	9-1/4"	46WT09C
	9-1/4"	46RT09C
Double Row and Top Ties	15-1/4"	46RT15C
	18-1/4"	46RT18C
	36-1/4"	46RT36C
	3/8" x 2-1/4"	9280
Concrete Anchors	3/8" x 3-3/4"	9281
	6"	46RT06
Flue Spacing Components	6"	46AX153
Foot Plate	-	46FP0H
Shim (plated)	3-1/2" x 2"	46FPS00Z

## Record Storage Box Support:

Includes Hardware. Used in place of particle board to support boxes and maintain neat, organized storage. Supplied with nylon button fasteners

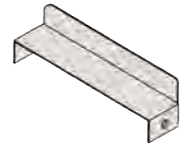

## Hanger Bar:

1-1/4" x 1-1/4". For hanging items between double rivet beams. One or more may be used per level.

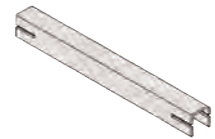

## Beam Cleat:

An economical way to add on units. Not recommended for heavy loads.

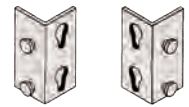

## Slotted Angle Cleats:

For use where slotted angle pieces must be joined, such as special grating supports and top ties.

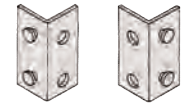

## Tie Plate:

Used to join Angle Post units side by side to insure proper row alignment.

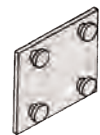

## Miscellaneous Accessories

Item Desc.	Size	Standard Cat. No.
Record Storage Box Support	15"	46BS15
	30"	46BS30
	32"	46BS32
Hanger Bar	36"	46BH36C
	42"	46BH42C
	48"	46BH48C
	60"	46BH60C
	Beam Cleat	Left
Right		46BC01C
Slotted Angle Cleat	Left	46SA00C
	Right	46SA01C
Tie Plate	-	46TP00C

# RivetRite® Shelving Components

## Shelving & Main Aisle Support:

To support decking across shelving or main aisle. Spacing between supports not to exceed 48". Includes

Hardware to bolt to posts - formerly called Cross Aisle Support, it can be used with both Tee and Angle Posts.

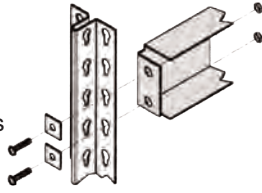

## Deck-Over Grating Supports:

3-1/2". Provides sturdy and secure support for grating when decking over entire installation.

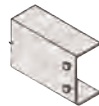

## Down Aisle Grating Supports:

3-1/2". Attaches to unit front between rows to provide support for channel-lock grating planks on two level shelving installations when grating is placed in a cross aisle pattern. Used with grating in lengths from 30" to 48".

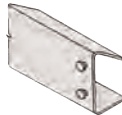

Multi-Level Supports		
Item Desc.	Size	Standard Cat. No.
Shelving & Main Aisle Support	30-1/4" x 3-1/2"	46AX30H
	36-1/4" x 3-1/2"	46AX36H
	42-1/4" x 3-1/2"	46AX42H
	48-1/4" x 3-1/2"	46AX48H
Deck-Over Grating Supports	36"	46GS36C
	42"	46GS42C
	48"	46GS48C
	60"	46GS60C
	69"	46GS69C
	72"	46GS72C
Down Aisle Grating Supports	36"	46DA36C
	48"	46DA48C
	60"	46DA60C
	69"	46DA69C
	72"	46DA72C

## Grating Planks:

Penco Channel-Lock grating provides for sure-footed movement on aisles and upper level storage areas. Interlocking grating has male and female flanges that interlock with adjacent planks providing a continuous locked surface. Non-locking grating planks butt against one another.

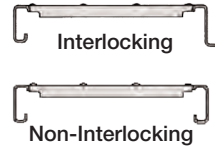

## Grating Fillers:

3" Wide Galvanized Grating Fillers.

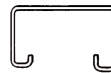

## Wire Decking:

Won't trap dirt - makes overhead sprinklers more effective. Easy installation. Contact your Penco representative for more information.

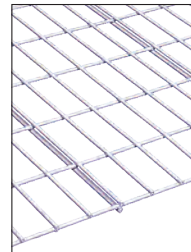

## Particle Board Shelf Decks:

Penco 1-M-1 interior grade particle board is available pre-cut to fit, or purchase from your local building materials supplier. Other types and thicknesses of deck may be desired based on load or use.



NOTE: Check 5/8" Particle Board capacity for the unit you require. Shelf deck capacity may not carry the rating of the steel framing.

If you are cutting your own board, use nominal size and cut to +0" -1/8".

Particle Board Shelf Decking					
Width	Depth	Cat. No.	Width	Depth	Cat. No.
36"	12"	94603	60"	18"	94635
	15"	94604		24"	94636
	18"	94605		30"	94637
	24"	94606		36"	94638
	30"	94607		48"	94639
	36"	94608		69"	15"
42"	12"	94613	30"		94647
	15"	94614	18"		94655
	18"	94615	24"	94656	
48"	24"	94616	72"	30"	94657
	30"	94617		36"	94658
	36"	94618		48"	94659
	12"	94623		96"	18"
18"	94625	24"	94666		
24"	94626	30"	94667		
30"	94627	36"	94668		
36"	94628	48"	94669		
48"	94629	-	-		-

Grating & Wire Shelf Decks		
Item Desc.	Size	Standard Cat. No.
Grating Planks Interlocking	30"	8AL030C
	36"	8AL036C
	42"	8AL042C
	48"	8AL048C
	72"	8AL072
	108"	8AL0108
	144"	8AL144
Grating Planks Non-Interlocking	30"	8GL030C
	36"	8GL036C
	42"	8GL042C
	48"	8GL048C
	72"	8GL072
	108"	8GL108
3" Wide Grating Fillers	144"	8GL144
	30"	8FK030C
	36"	8FK036C
	42"	8FK042C
	48"	8FK048C
	72"	8FK072
Wire Decking	108"	8FK108
	144"	8FK144
	-	Contact your Penco Rep

# RivetRite® Shelving

## Technical Information - Growth/Width/Beams

### Unit Growth Chart

WHEN DESIGNING A SHELVING LAYOUT, UNIT GROWTH MUST BE CONSIDERED. TO DETERMINE THE OVERALL DIMENSION OF A CONTINUOUS ROW OF SHELVING EMPLOYING TEE POSTS OR ANGLE POST WITH TIE PLATES.

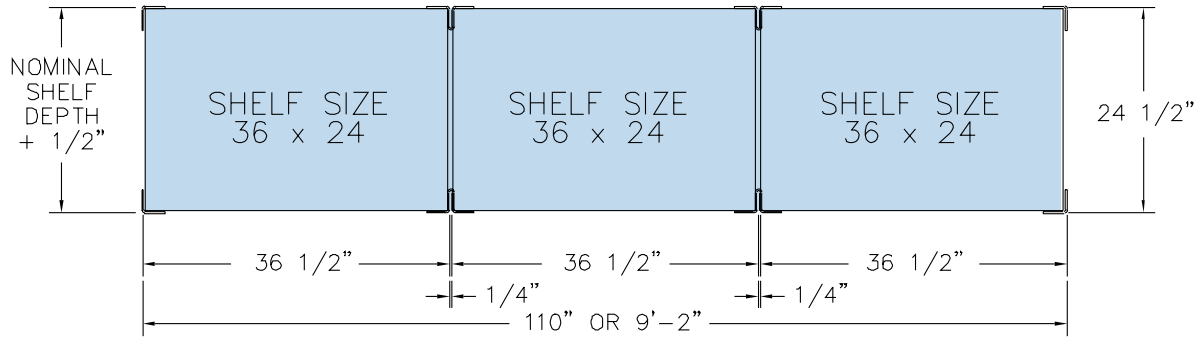

### Unit Clear Width

EXAMPLES BELOW ARE BASED ON 36" WIDE SHELF

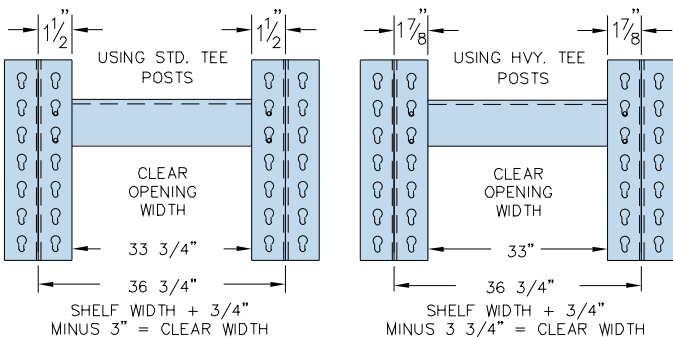
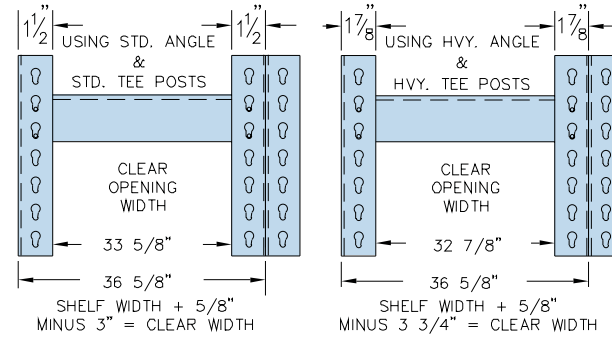
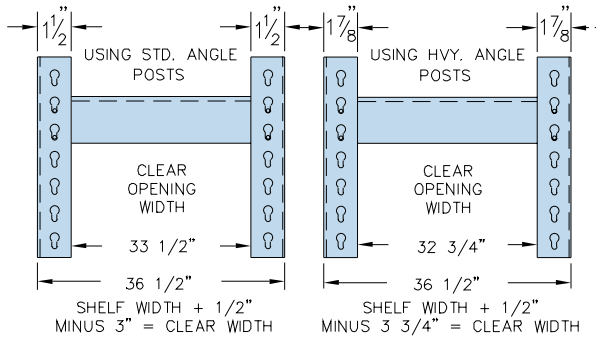

### Beam Profiles

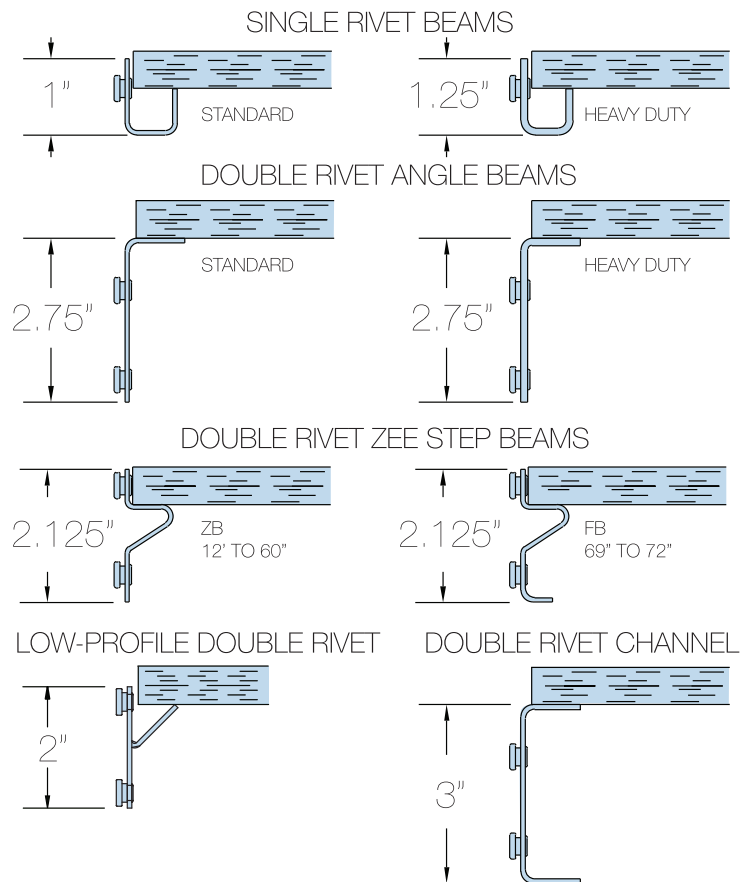

**RivetRite®**

### Vertical Clear Opening Using 5/8" Shelf Deck Material

#### UNITS USING SINGLE RIVET SHELF BEAMS

UNITS WITH STANDARD DUTY SINGLE RIVET BEAMS (DBL. RIVET AT TOP and BOTTOM)

UNITS WITH HEAVY DUTY SINGLE RIVET BEAMS (DBL. RIVET AT TOP and BOTTOM)

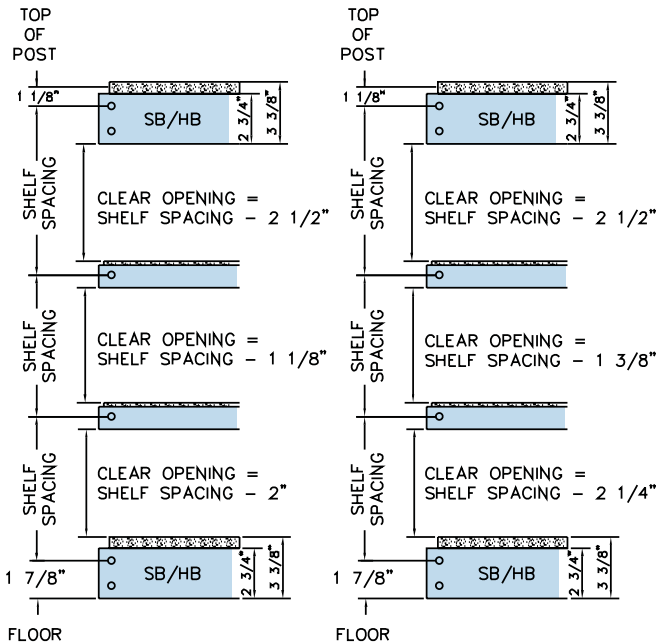

#### UNITS USING ZEE, ANGLE AND CHANNEL BEAMS

UNITS WITH ZEE BEAMS

UNITS WITH ANGLE BEAMS AND CHANNEL BEAMS

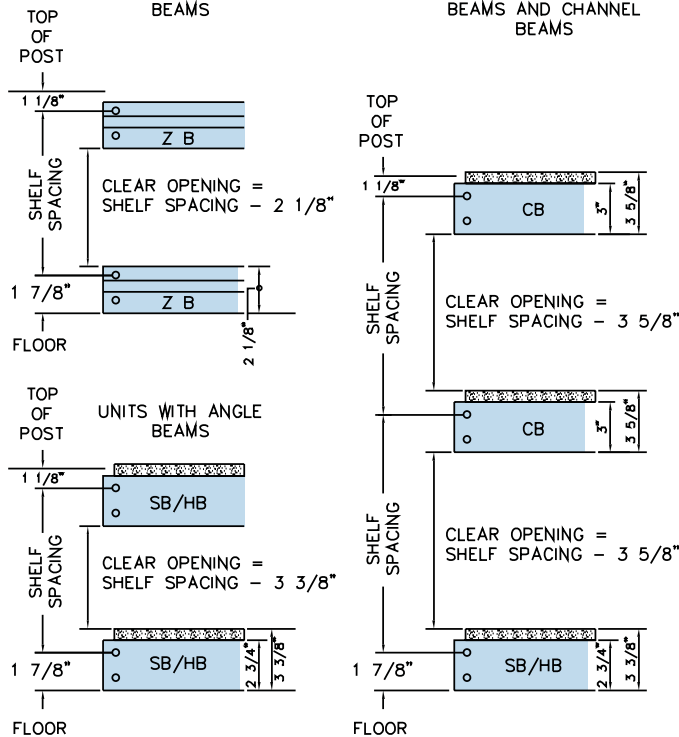

#### VERTICAL SHELF CLEARANCE

THIS CHART DEPICTS SHELF CLEARANCES FOR TYPICAL RIVET RITE SHELVING UNITS WITH 1 1/2" VERTICAL SHELF ADJUSTMENT.

#### SINGLE RIVET HIGH DENSITY SHELVING UNITS

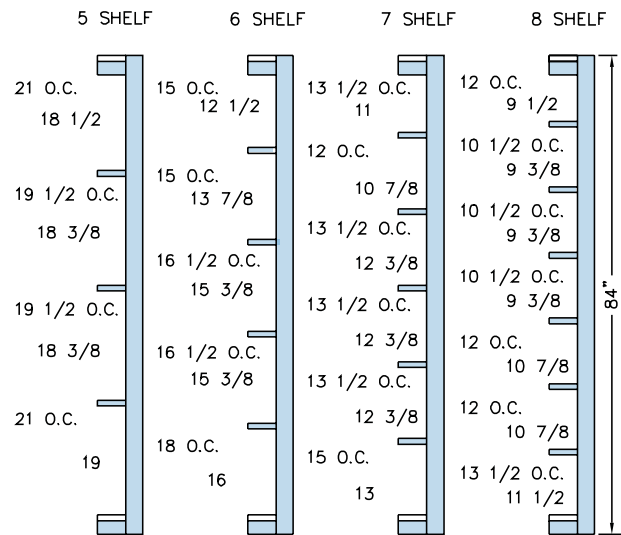

#### DOUBLE RIVET BULKY SHELVING UNITS

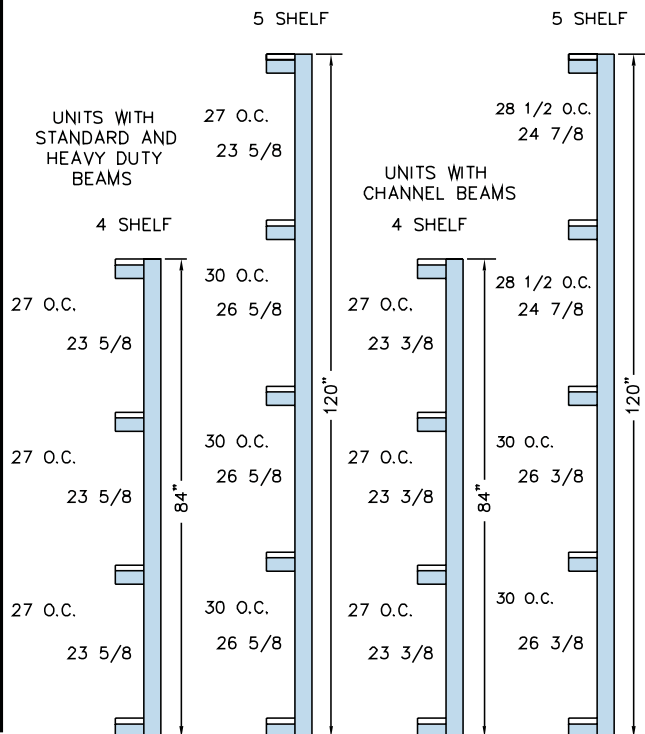

# RivetRite® Shelving

## QuickShip Components



For lead times and warehouse locations, go to:  
[pencoproducts.com/lead-times](http://pencoproducts.com/lead-times)  
[pencoproducts.com/quickship](http://pencoproducts.com/quickship)



### RivetRite® QuickShip Shelving Components

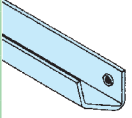
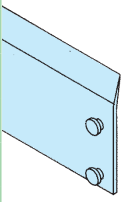

If you prefer to order RivetRite by its individual component, you can obtain many of the most popular sizes and accessories through the QuickShip program. By mixing beam sizes, you can create some sizes that are not available as pre-configured units on the previous page.

For detailed descriptions of components, see pages 32-34. All RivetRite QuickShip items are finished in 723 Light Putty powder coat paint. See beam capacities on page 35.

Shelf deck material is not available in the QuickShip program. It must be obtained outside the QuickShip program or purchased locally (particleboard supplied by Penco on a production order basis is classified as '1-M-1 Interior Grade'). If you are cutting your own board, use the nominal shelf deck size and cut +0", -1/8".

RivetRite® Beams				
	Item	Size	Cat. No.	
	Single Rivet Shelf Beams	12"	46SS12P	
		18"	46SS18P	
		24"	46SS24P	
		30"	46SS30P	
		"SS" & "HS"*	36"	46SS36P
		42"	46SS42P	
		48"	46SS48P	
		48"	46HS48P *	
	Double Rivet Angle Beams	12"	46SB12P	
		15"	46SB15P	
		18"	46SB18P	
		24"	46SB24P	
		30"	46SB30P	
		36"	46SB36P	
		42"	46SB42P	
		"SB" & "HB"*	48"	46HB48P*
		60"	46HB60P*	
		69"	46HB69P*	
		72"	46HB72P*	
		84"	46HB84P*	
96"	46HB96P*			

RivetRite® Posts			
	Item	Size	Cat. No.
	Angle Posts	72"	46AS06P
		84"	46AS07P
		96"	46AS08P
		120"	46AS10P
			Tee Posts
84"	46TS07P		
96"	46TS08P		
120"	46TS10P		

Miscellaneous Accessories			
	Item	Size	Cat. No.
	Tie Plate	-	46TP00P
	Foot Plate	-	46FP0H
	Concrete Anchor	3/8" x 2-1/4"	9280

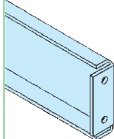
Center Supports			
	Item	Size	Cat. No.
	Center Support with Hardware	15"	46CS15P
		18"	46CS18P
		24"	46CS24P
		30"	46CS30P
		36"	46CS36P
		48"	46CS48P





For lead times and warehouse locations, go to:  
[pencoproducts.com/lead-times](http://pencoproducts.com/lead-times)  
[pencoproducts.com/quickship](http://pencoproducts.com/quickship)

# RivetRite® Shelving

## QuickShip Shelving

### RivetRite® QuickShip Shelving Units

- Quick Shipment in attractive 723 Light Putty powder coat finish
- Economical
- Choice of beam types
- Accessibility on all four sides
- Beams adjust on 1-1/2" vertical centers
- Boltless construction for easy assembly
- Starter & Adder configurations with Angle & Tee Posts
- Accessories available: Anchors, Foot Plates, Tie Plates



NOTE: Shelf Deck material is NOT included with the units. You must obtain shelf deck material separately.

### Single Rivet High Density Units (With Double Rivet Beams at Top/Bottom - 84" High)

Unit Width	Shelf Depth	5 Shelf Cat. No.	6 Shelf Cat. No.	7 Shelf Cat. No.	8 Shelf Cat. No.
36" Starter Units	12"	461315P	461316P	461317P	461318P
	18"	461325P	461326P	461327P	461328P
	24"	461335P	461336P	461337P	461338P
	36"	461345P	461346P	461347P	461348P
36" Add-On Units	12"	462355P	462356P	462357P	462358P
	18"	462365P	462366P	462367P	462368P
	24"	462375P	462376P	462377P	462378P
	36"	462385P	462386P	462387P	462388P
48" Starter Units	12"	461415P	461416P	461417P	461418P
	18"	461425P	461426P	461427P	461428P
	24"	461435P	461436P	461437P	461438P
	36"	461445P	461446P	461447P	461448P
48" Add-On Units	12"	462455P	462456P	462457P	462458P
	18"	462465P	462466P	462467P	462468P
	24"	462475P	462476P	462477P	462478P
	36"	462485P	462486P	462487P	462488P



### Double Rivet Bulky Storage Units (With 4 Shelves - 84" High)

Unit Width	Shelf Depth	WITHOUT Center Support		WITH Center Support	
		Starter Cat. No.	Add-On Cat. No.	Starter Cat. No.	Add-On Cat. No.
48" Wide Units	18"	46001HP	46006HP	46W01HP	46W06HP
	24"	46002HP	46007HP	46W02HP	46W07HP
	30"	46003HP	46008HP	46W03HP	46W08HP
	36"	46004HP	46009HP	46W04HP	46W09HP
	48"	46005HP	46010HP	46W05HP	46W10HP
60" Wide Units	18"	46011HP	46016HP	46W11HP	46W16HP
	24"	46012HP	46017HP	46W12HP	46W17HP
	30"	46013HP	46018HP	46W13HP	46W18HP
	36"	46014HP	46019HP	46W14HP	46W19HP
	48"	46015HP	46020HP	46W15HP	46W20HP
72" Wide Units	18"	46021HP	46026HP	46W21HP	46W26HP
	24"	46022HP	46027HP	46W22HP	46W27HP
	30"	46023HP	46028HP	46W23HP	46W28HP
	36"	46024HP	46029HP	46W24HP	46W29HP
	48"	46025HP	46030HP	46W25HP	46W30HP
96" Wide Units	18"	-	-	46W31HP	46W36HP
	24"	-	-	46W32HP	46W37HP
	30"	-	-	46W33HP	46W38HP
	36"	-	-	46W34HP	46W39HP
	48"	-	-	46W35HP	46W40HP

### Double Rivet Bulky Storage Units (With 5 Shelves - 120" High)

Unit Width	Shelf Depth	WITHOUT Center Support		WITH Center Support	
		Starter Cat. No.	Add-On Cat. No.	Starter Cat. No.	Add-On Cat. No.
72" Wide Units	30"	46041HP	46044HP	46W41HP	46W44HP
	36"	46042HP	46045HP	46W42HP	46W45HP
	48"	46043HP	46046HP	46W43HP	46W46HP
96" Wide Units	30"	-	-	46W47HP	46W50HP
	36"	-	-	46W48HP	46W51HP
	48"	-	-	46W49HP	46W52HP

### Archive Shelving Units (For Use with Decking - 84" High)

Unit Width	Shelf Depth	5 Shelf Cat. No.
42" Starter Units	15"	46601AP
	30"	46602AP
42" Add-On Units	15"	46613AP
	30"	46614AP
69" Starter Units	15"	46603AP
	30"	46604AP
69" Add-On Units	15"	46615AP
	30"	46616AP

# RivetRite® Shelving

## Capacities

RivetRite Post Capacity Chart		
Recommended safe loads (per post) for use only where seismic forces are not a factor.		
Beam Spacing (inches)	Standard Angle Post Capacity (lbs.)	Heavy Duty Angle Post Capacity (lbs.)
12	1530	1735
18	1520	1720
24	1510	1695
30	1490	1680
36	1350	1660
42	990	1560
48	755	1195
Beam Spacing (inches)	Standard Tee Post Capacity (lbs.)	Heavy Duty Tee Post Capacity (lbs.)
12	4725	5045
18	4510	4965
24	4210	4850
30	3825	4705
36	3350	4525
42	2795	4315
48	2180	4075
For beam spacing over 48", please contact Penco.		
Post capacities are based on the maximum vertical distance between left to right beams or front to back beams, whichever is greater. In single rivet beam units, the vertical distance between front to back beams will usually govern.		
Tie plates must be spaced no more than 48 inches apart to insure structural stability when joining angle posts together.		
The above capacities are NOT intended for use when designing multi-level systems or for specific requirements where seismic forces are a factor. For specific multi-level or seismic requirements, contact your Penco District Manager.		

RivetRite Beam Capacities		
Recommended Safe Use Allowable Uniformly Distributed Hand Loaded Static Beam Loads		
Length (in.)	Cap./Pair (lbs.)	Deflection (in.)
<b>Single Rivet Shelf Beams</b>		
<b>Standard Beams</b>		
36	350	0.25
42	300	0.30
48	250	0.34
<b>Heavy Duty Beams</b>		
36	600	0.25
42	550	0.30
48	500	0.34
<b>Double Rivet Angle Beams</b>		
<b>Standard Beams</b>		
Without Center Supports (***)		
36	1000	***
42	780	***
<b>Heavy Duty Beams</b>		
Without Center Supports (***)		
48	750	***
60	600	***
69	525	***
72	500	***
With Center Supports (*)		
48	1400	0.16
60	1200	0.25
69	1050	0.33
72	1000	0.36
84	840	0.49
96	620	0.53
<b>Double Rivet Channel Beams</b>		
With Center Supports (*)		
60	2240	0.23
72	1850	0.33
84	1600	0.45
96	1400	0.59
<b>Double Rivet Zee Step Beams</b>		
Without Center Supports		
48	1250	-
60	750	-
69	600	-
72	600	-
With Center Supports (*)		
48	1750	
60	1000	
69	1000	
72	1000	
(*) One (1) support per pair of beams except 96' which have two (2) Supports		
(***) Beam rotation is less than 5 degrees		

Low Profile Double Rivet Beam Capacities	
With 5/8" Particle Board Decking (All 4 Sides Supported)	
Shelf Size W x D (in.)	Capacity (lbs.)**
36x12	193
36x15	203
36x18	212
36x24	231
36x30	255
36x32	266
36x36	293
42X12	166
42X15	168
42X18	170
42X24	176
42X30	187
42X32	192
42X36	204
48x12	136
48x15	136
48x18	136
48x24	138
48x30	143
48x32	145
48x36	150
48x42	162
48x48	181
The Low-Profile RivetRite Beam capacities shown here are for all four sides of a shelf deck supported (front and rear, and both sides). All loading calculations are based upon ANSI standard MH 28.2-1996 (L/140)**. The allowable loads shown are uniformly distributed and assume 5/8" thick particle board is the shelf deck material.	
Other decking material, such as plywood or steel, may change unit load capacities. For special sizes not listed here, please direct your inquiries to the Shelving Product Managers and include as much detail about the proposed installation as possible.	
* Capacities shown are for Evenly Distributed Loads	
** L = Length	





# RivetRite® Shelving

## Specifications

**Components:** Choose from a wide selection of component sizes and capacities to fit the storage requirements.

**Angle Post:** 1-1/2" x 1-1/2" (Standard Duty): Used as upright post for standard RivetRite units.

**Angle Post:** 1-7/8" x 1-7/8" (Heavy Duty): When maximum capacity and stability are essential, the heavy duty angle post is the proper choice. Ideally suited for two level shelving, storage deck and high rise shelving applications.

**Tee Post:** 3" x 1-1/2" (Standard Duty): Included with standard duty add-on units to function as a common post between starter and adjoining units.

**Tee Post:** 3-3/4" x 1-7/8" (Heavy Duty): Used in the same way as the standard tee, when increased load capacities are required.

**Single Rivet Shelf Beam (Standard Duty):** Primarily used as an intermediate shelf support when maximum vertical space between levels is needed. Furnished as standard on High Density Shelving units.

**Single Rivet Shelf Beam (Heavy Duty):** Manufactured to provide maximum capacity with very little loss of usable vertical space between shelves.

**Double Rivet Shelf Beam (Standard Duty):** Used to establish unit stability and to provide shelf support on all four sides.

**Double Rivet Shelf Beam (Heavy Duty):** Provides stability and increased load capacity in the longer lengths.

**Double Rivet Channel Beam:** Designed to provide maximum left to right stability and higher capacity than standard or heavy duty beams. Cannot be used at floor level.

**Center Support:** Used with double rivet beams to provide front-to-rear support for shelf deck and provides added stability to beams.

**Double Rivet Low Profile Beams:** Designed to provide maximum clear shelf spacing for Double Rivet Shelf Units with light load requirements.

**Double Rivet Zee Step Beams:** Reduced profile increases vertical clearance by 1-1/4" between shelf levels when used in place of Double Rivet Angle Beams. Protects decking edges. When used as the bottom shelf on Single Rivet Units clear space between the bottom and first shelf is increased by 1-1/4".

**Decking Support For Zee Step Beam:** Used with Zee Step Beams for front to back decking support.

**TYPES OF UNITS:** RivetRite Units come in two basic types: Single Rivet Units and Double Rivet Units. These utilize different combinations of beam types. In addition, units for special purposes include Records Storage Units and Automotive Parts Storage Units.

**Double Rivet Bulky Storage Units:** 48" to 96" wide beams Access to stored items from all sides Choice of beam capacity to meet your storage requirement Easy assembly without special tools Units available in 84" and 120" heights Penco RivetRite bulky shelving is designed to provide an economical solution for the storage of retail, wholesale or industrial goods. Installation can be done without special tools in a minimum amount of time. All steel parts are finished in attractive 723 Light Putty baked enamel. v Starter and add-on units are combined to form economical rows of shelving. Each add-on unit includes a pair of tee posts which are used in common between units. This reduces assembly time and the number of parts required. Begin each row with two angle posts from the starter unit and join the desired number of add-on units to complete the row. Finish the last unit with a pair of angle posts from the starter unit.

**Single Rivet High Density Units:** Single Rivet high density shelving uses single rivet beams on intermediate levels, and double rivet beams at the top and bottom for rigidity. For units up to 48" wide. High Density Shelf Beams provide maximum space between shelf levels Common tee posts between starter and add-on unit Shelf levels adjust on 1-1/2" centers Fast easy assembly Optional heavy duty single rivet shelf beams available

for added capacity Penco Single Rivet beam High Density shelving is designed to provide for maximum vertical clearance between shelves. Access to stored item from all sides is possible because side and back cross braces are not necessary for stability. Add-on units assemble quickly without special tools by using a common tee post between units. Finished in 723 Light Putty baked enamel. Starter and add-on units are combined to form economical rows of shelving. Each add-on unit includes a pair of tee posts which are used in common between units. This reduces assembly time and the number of parts required. Begin each row with two angle posts from the starter unit and join the desired number of add-on units to complete the row. Finish the last unit with a pair of angle posts from the starter unit. All intermediate shelves on units that exceed 24" deep utilize single rivet beams for front to back shelf deck support. Units 12", 18" and 24" deep include one pair of single rivet beams for intermediate use front to back.

**Record Storage Units:** RivetRite Record Storage Units aid in records management by providing an organized solution to high density archive storage. Two types of units are available; one that utilizes particle board decking to support the boxes, and an all steel unit with specially designed box supports. (Particle board must be ordered separately). Fire insurance premium savings may be realized by using units with steel box supports. Check with your insurance carrier. Add-on units utilize a common Tee Post between units to save time during assembly. All unit box capacities are based on a standard archive box size of approximately 12-1/2" wide x 16-1/2" deep x 10-1/2" high.

### AUTOMOTIVE PARTS STORAGE UNITS

**Tire Storage Rack:** Penco RivetRite Tire Racks provide for the neat organized storage of standard automobile or light truck tires. Specially designed beams with a 30 degree flange on the top securely cradle the tires. Available in Single-Row, (12" deep units with 9" Wall Ties) and Double-Row, (two 12" deep units separated by 18" Double Row Spacers). Unit depth shown includes wall ties/row spacers.

**Muffler Storage:** Uniform storage of various size mufflers is achieved through the use of RivetRite Muffler Storage Units. As with all RivetRite units, ease of assembly and access from all sides is standard. Add-on units utilize common Tee Posts between units. Particle Board must be ordered separately for each level.

**Hanging Tailpipe Rack:** Designed specifically for the storage of automotive and light truck tailpipes. Assembles in minutes without special tools. Stored items are visible and easily accessible.

**RivetRite Two-Level Storage:** The structural integrity of RivetRite lends itself to the construction of two-level storage facilities for applications where maximum utilization of overhead space is required. Expanding in an upward direction instead of outward keeps your personnel in closer proximity to each other and stored material, for more efficient operation. Using standard components for support, economical units may be constructed with an open deck-over upper level, or additional shelving. In either case, savings are realized because: You virtually double the amount of storage space in a given floor area You utilize existing heat and air conditioning within the building Construction is as uncomplicated as standard single level shelving. Beams and grating supports lock into strong one-piece posts without hardware. Penco Channel-Lock Safety Grating installs easily for a rigid walking surface. The utility of a RivetRite two-level installation has unlimited possibilities. Shelf heights are adjustable on 1-1/2" centers Shelves can be accessed from all four sides RivetRite two level shelving systems are designed to meet your specifications. Contact your representative for assistance in reviewing your two-level shelving requirements.

RivetRite® is a registered trademarks of Penco Products, Inc.

PENCO RESERVES THE RIGHT TO VARY SPECIFICATIONS CONSISTENT WITH A POLICY OF CONTINUOUS PRODUCT IMPROVEMENT.



# Pallet Rack

## Introduction

### Penco Pallet Rack

Penco Pallet Rack is a carefully engineered system designed to provide highly efficient storage of palletized items. Combining design and excellence with the use of high strength steel to achieve a superior strength to weight ratio, Penco Pallet Rack can handle nearly any storage job you can give it.

The basic components of Penco Pallet Rack are Upright Frames and Beams. Each is manufactured to exacting tolerances to provide many years of dependable service at their rated loads.

The following pages detail the wide range of sizes, capacities and accessories that make Penco Rack one of the best values for your storage dollar.

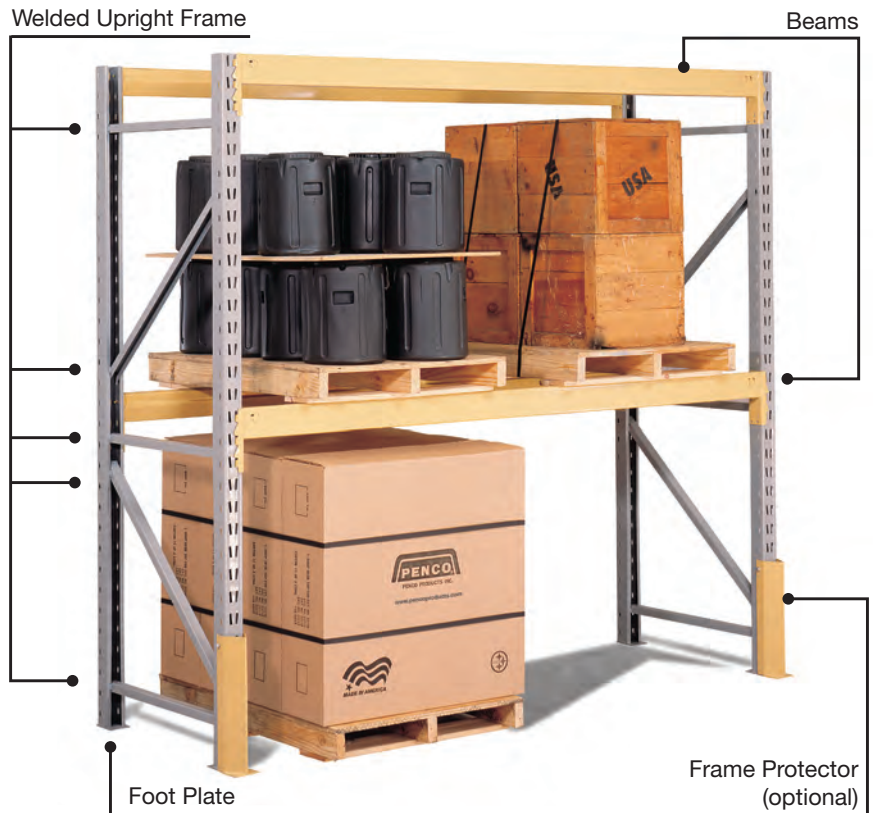

### Design Features

#### Heavy Duty Beam End Connector

Beam ends are made from extra heavy gauge steel. They feature a three prong connection which assures positive beam to post alignment along the 8-1/2" length of the connector, and uniform load distribution. The greater the load, the tighter the connection. Tabs extend along the face of the beam to provide extra protection to the prongs during transit and installation.

#### Upright Column

A continuous post roll formed in 5 different shapes and 3 different metal thicknesses to handle a variety of loads. Slanted slots on the column allow for beam placement on 3" vertical centers. Slots on column sides accept the safety beam locking key. The design allows for beams to be placed flush with the top, or as close as 9" from the floor.

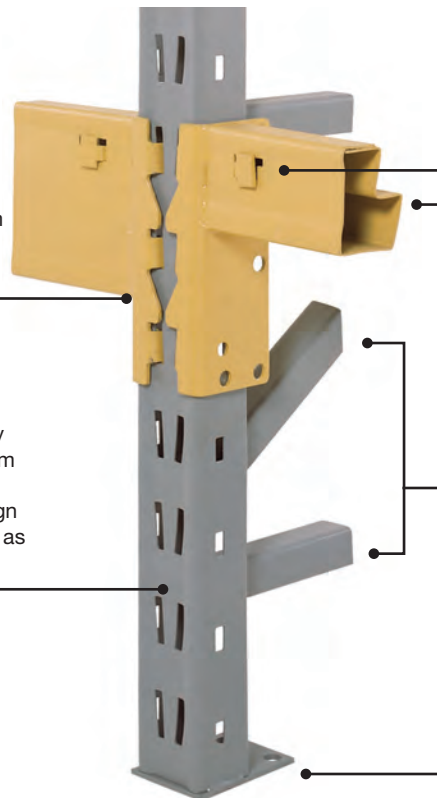

#### Beam Locking Key for Safety

A unique recessed safety key made from heavy gauge steel engages a slot in the side of the post. It resists an upward force from material handling equipment up to 1000 pounds. It is an integral part of the beam assembly, can be engaged easily without tools, and is clearly visible for checking.

#### Step Down Design

All beams have a step for the purpose of accepting accessories. Two step sizes are available: 7/8" and 1-5/8" high.

#### Welded Upright Frame Bracing

Upright frame columns are securely MIG welded together with channel type braces for maximum rigidity.

#### Foot Plate

A heavy gauge foot plate is securely welded to each post to provide load distribution over 13.7 square inches, and two holes allow for floor anchoring from either side of the frame.

# Pallet Rack Design Considerations

## Determining Pallet Rack Needs

- A. Height:** Measure the vertical dimensions of the pallet, pallet load and beam. Add an extra 4" to 6" clearance between bottom of beam above and top of load on pallet. Top beam should be at least 6" lower than the maximum lifting height of your forklift.
- B. Depth:** Measure the depth of the pallet. Pallet should overhang the frame by 3" front and back. (Example: for a 48" deep pallet use a 42" deep frame).
- C. Width:** Measure the width of the load and pallet, and use the greater of the two. Add 3" to 4" between loads, and between loads and upright frames to determine correct beam length. Select beams with a capacity equal to or greater than the total load of each level. (See "How to Order Beams" on the Pallet Rack Beam page).
- D. Frame Capacity:** Add the total weight of all loads for each bay, excluding the pallets on the floor (a bay is the space between two upright frames).
- E. Frame:** A common frame should be used between each bay.

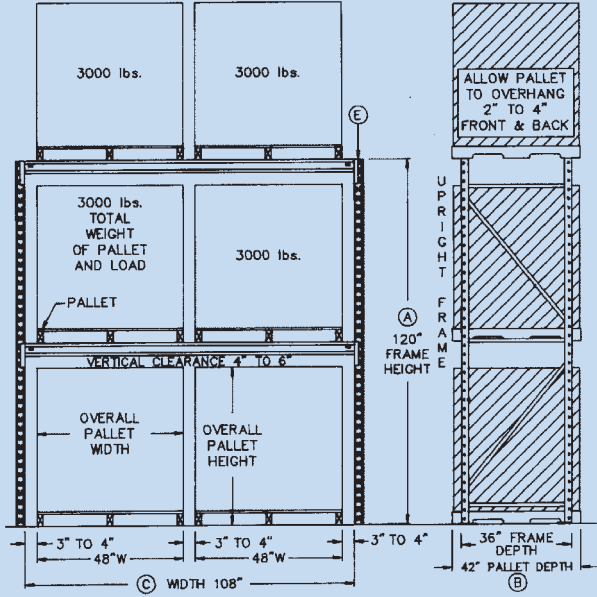

## Pallet Rack Plus - An option for severe conditions or high seismic activity

Penco Pallet Rack Plus is engineered for use in areas where high seismic activity or other severe conditions exist. Load capacities are the same as the standard pallet rack shown in this catalog, however the frames and beams are more resistant to horizontal and vertical forces that could damage standard rack and its load. To learn the seismic rating where your pallet rack will be in use, contact your Penco representative.

of 3 for a stronger connection between the beam and the upright post to resist conditions with higher lateral forces. The beam is welded 3" down from the top of the connector so loading is evenly distributed across all four connector prongs. The beam locking key is the same as used on standard beams.



**Plus Beam End Connectors:**  
The Plus beams have 4 connectors instead

**Plus Upright Frames with Large Footplates:**  
Each Plus upright frame has two 5" x 7" x 3/8" thick footplates with four 9/16" diameter anchoring holes. The extra holes provide the installer with more choices for floor anchoring.

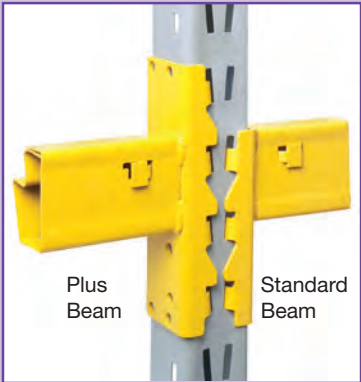
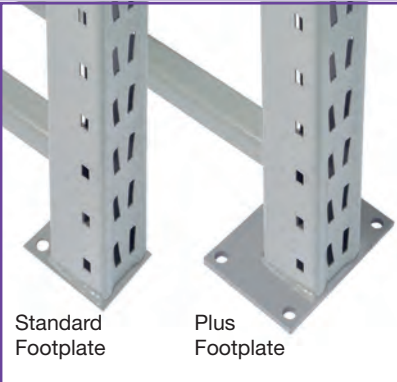
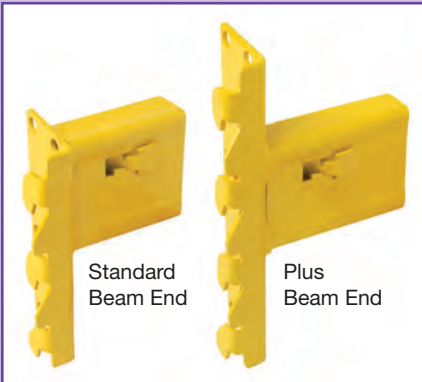

# Pallet Rack Upright Frames

Penco Pallet Rack Upright Frames are available in five load capacities. A letter code stamped into the face of the post indicates the frame type. Depths of 30", 36", 42", 48", 54" and 60" are standard, but other depths and double-posted and cantilever frames are available. Standard heights range from 48" to 240" in 6" increments, but greater heights can be achieved when splices are used.

Beam heights adjust on 3" vertical centers, and are independent on each side of the frame. Beams of any type can be placed along the full height of the post; there are no dead spots on the post, even across a splice. Various load rated frames can be combined in a row of rack for maximum economy.

Penco Pallet Rack Upright Frames are furnished completely fabricated, welded into rigid units.

## Panel Construction:

Four standard types of panel construction are illustrated.

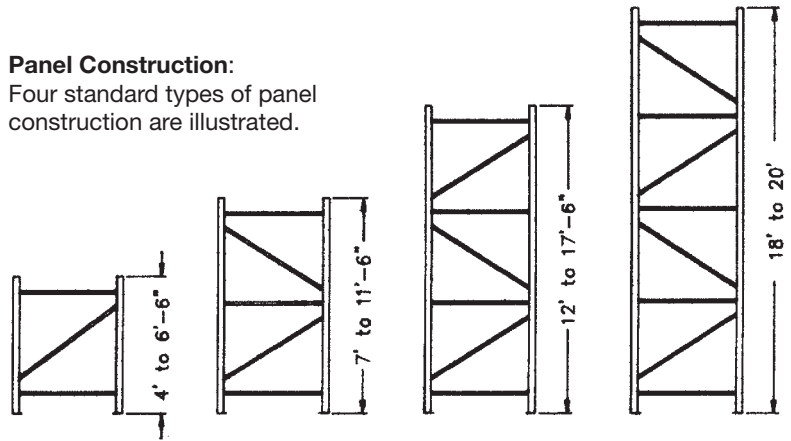

## How To Select Upright Frame Type

1. Determine the maximum vertical opening dimension between pairs of beams or between the lowest beam level and the floor.
2. Calculate the total load imposed on the upright frame.
3. Using the charts below, find the maximum vertical spacing between beams along the bottom scale, and then draw a vertical line to intersect the lines representing the capacities of the five types of upright frames. Select the frame that has a capacity that equals or exceeds the total load imposed upon it by all beam levels.

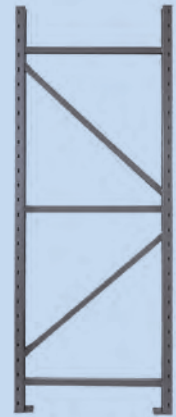

## Upright Frame Types

Frame Types	Post Width	Post Depth	Post Gauge
F	3"	1-3/4"	14
G	3"	2-1/4"	14
P	3"	3"	14
R	3"	3"	13
T	3"	3"	12

## Upright Frame Capacity

Frame Type	Beam Spacing											
	24"	30"	36"	42"	48"	54"	60"	66"	72"	78"	84"	90"
F	22,555	21,213	19,853	18,528	16,929	15,381	13,543	11,773	9,824	8,439	7,216	6,336
G	26,512	25,236	23,839	22,311	20,663	18,904	17,025	15,015	12,864	10,774	9,306	8,110
P	32,751	31,227	29,555	27,932	25,965	24,342	21,871	19,203	17,212	14,630	12,540	11,026
R	39,108	37,264	35,464	33,266	30,891	28,339	25,934	23,043	19,959	17,245	14,796	12,834
T	45,629	43,478	41,102	38,503	35,715	32,703	29,897	26,489	22,875	19,432	16,713	14,527

The table above indicates capacities for various vertical beam spacings for the different Penco upright frame types. Load data shown is for preliminary consideration only. Each installation must be individually evaluated for actual conditions and the use of each element in relation to the entire system with all aspects of the structural function.

# Pallet Rack

## Upright Frame Accessories

### Rigid Row Spacer

Structurally connects and spaces two rows of rack back-to-back. Bolted type. Hardware included.



Rigid Row Spacer	
Space	Cat. No.
6"	5AR506
8"	5AR508
10"	5AR510
12"	5AR512
18"	5AR518
24"	5AR524
30"	5AR530
36"	5AR536
42"	5AR542
48"	5AR548
54"	5AR554
60"	5AR560

### Rigid Wall Spacer

Assures that uniform spacing between pallet rack and building wall is maintained. Frame hardware included.



Rigid Wall Spacer	
Space	Cat. No.
4"	5AR404
6"	5AR406
8"	5AR408
10"	5AR410
12"	5AR412
18"	5AR418

### Reel Holder

Accessorizes rack for reel storage. Max. axle 2-1/2" dia. Cat. No. 5AH000



### Concrete Floor Anchor

To anchor pallet rack upright frames to a concrete floor. 1/2" diameter x 3-3/4". High seismic areas may require other floor anchors. Check with local permitting agency for assistance, if required. Cat. No. 9580



### Frame Protector

Anchors to floor at front of post. Provides protection against damage from material handling vehicles. NOT for use on Pallet Rack PLUS upright frames. Includes hardware to fasten to post only. 18" high. Cat. No. 5AF018



### Frame Deflector

Fastens to post only, usually 1-1/2" above the footplate. Includes hardware to bolt to post. 18" High. Cat. No. 5AF021PC



### Frame Splice

For adding to height of existing frame. Can be supplied welded in top of new frame if specified on order. (Top frame must be ordered without foot plate.) With hardware.



Frame Splice	
Frame Type	Cat. No.
F, G, P	5AU008P
R, T	5AU018P

### Upright Frames - Available Sizes

Frame Height	Frame Depths					
	30"	36"	42"	48"	54"	60"
48"						
54"						
60"						
66"						
72"						
78"						
84"						
90"						
96"						
102"						
108"						
114"						
120"						
126"						
132"						
138"						
144"						
150"						
156"						
162"						
168"						
174"						
180"						
186"						
192"						
198"						
204"						
210"						
216"						
222"						
228"						
234"						
240"						

= Available = Not Available

To add height to an Upright Frame, a splice can be added. For more information on splicing frames see the Frame Splice to the left.

### Upright Frame Catalog # System

Position	1	2	3	4
Cat. No.	5	F	E	096

#### DESCRIPTION OF PART NO. SEQUENCE:

1. Always a 5 2. Capacity code for frame (See Pallet Rack Frame Capacities Table). 3. Depth code for frame (B = 30", E = 36", H = 42", L = 48", P = 54", S = 60") 4. Height of upright frame in inches (for example, 096 = 96 inches).

# Pallet Rack

## Pallet Rack Beams

### One Piece Beam Design

Penco has engineered its roll-formed one piece beams to achieve the highest possible strength-to-weight ratios in the most frequently desired load ratings through the use of efficient design and high strength steel.

Beams are offered in eight basic styles with different vertical profiles and steel gauges. Beam step heights of 7/8" and 1-5/8" are available for a wide variety of accessory use.

Both the overlapping seam and the beam end connector are securely MIG welded for strength.

The face of the beam has an M-design recessed configuration for added strength, protecting the locking key, and to accept pressure sensitive labeling. Each beam is stamped with an identifying letter referring to the load bearing capacity. Beams are shown in 710 Yellow.

### How to Order Beams

**1. Select the Required Clear Span (distance between posts).** Allow for a minimum of 3" between pallet and post, and a minimum of 4" between adjacent pallets. Allow additional separation if load overhangs the pallet. For sizes not shown, contact your Penco representative.

**2. Determine the Required Capacity.** Add up the maximum load to be placed on one pair of beams. Remember that capacities are based on evenly distributed loading, not point loading.

### Beam Selection

Clear Span*	B		D		H		J		N		S		X		Y	
	Capacity Per Pair**	Cat. No. Per Pair	Capacity Per Pair**	Cat. No. Per Pair	Capacity Per Pair**	Cat. No. Per Pair	Capacity Per Pair**	Cat. No. Per Pair	Capacity Per Pair**	Cat. No. Per Pair	Capacity Per Pair**	Cat. No. Per Pair	Capacity Per Pair**	Cat. No. Per Pair	Capacity Per Pair**	Cat. No. Per Pair
48"	8920 lb	5BB048	8380 lb	5BD048	9340 lb	5BH048	10670 lb	5BJ048	12170 lb	5BN048	-	-	-	-	-	-
54"	7920 lb	5BB054	7445 lb	5BD054	8370 lb	5BH054	9480 lb	5BJ054	10810 lb	5BN054	-	-	-	-	-	-
60"	7120 lb	5BB060	6695 lb	5BD060	7530 lb	5BH060	8520 lb	5BJ060	9730 lb	5BN060	-	-	-	-	-	-
66"	6470 lb	5BB066	6080 lb	5BD066	6840 lb	5BH066	7740 lb	5BJ066	8830 lb	5BN066	-	-	-	-	-	-
72"	5920 lb	5BB072	5570 lb	5BD072	6260 lb	5BH072	7090 lb	5BJ072	8090 lb	5BN072	9560 lb	5BS072	-	-	-	-
78"	5460 lb	5BB078	5135 lb	5BD078	5770 lb	5BH078	6540 lb	5BJ078	7460 lb	5BN078	-	-	10220 lb	5BX078	-	-
84"	5070 lb	5BB084	4760 lb	5BD084	5360 lb	5BH084	6060 lb	5BJ084	6920 lb	5BN084	-	-	9480 lb	5BX084	12650 lb	5BY084
90"	4720 lb	5BB090	4430 lb	5BD090	4990 lb	5BH090	5650 lb	5BJ090	6450 lb	5BN090	7630 lb	5BS090	8840 lb	5BX090	11800 lb	5BY090
96"	4420 lb	5BB096	3990 lb	5BD096	4670 lb	5BH096	5290 lb	5BJ096	6040 lb	5BN096	7190 lb	5BS096	8280 lb	5BX096	11050 lb	5BY096
102"	4160 lb	5BB102	3530 lb	5BD102	4390 lb	5BH102	4980 lb	5BJ102	5680 lb	5BN102	6720 lb	5BS102	7790 lb	5BX102	10390 lb	5BY102
108"	3920 lb	5BB108	3150 lb	5BD108	3990 lb	5BH108	4690 lb	5BJ108	5340 lb	5BN108	6340 lb	5BS108	7350 lb	5BX108	9800 lb	5BY108
114"	3540 lb	5BB114	2830 lb	5BD114	-	-	4440 lb	5BJ114	-	-	-	-	6950 lb	5BX114	9280 lb	5BY114
120"	3190 lb	5BB120	2550 lb	5BD120	3230 lb	5BH120	4130 lb	5BJ120	4810 lb	5BN120	5690 lb	5BS120	6600 lb	5BX120	8800 lb	5BY120
126"	2900 lb	5BB126	2310 lb	5BD126	-	-	-	-	4570 lb	5BN126	5410 lb	5BS126	6270 lb	5BX126	8370 lb	5BY126
132"	2840 lb	5BB132	-	-	-	-	-	-	4410 lb	5BN132	5160 lb	5BS132	5980 lb	5BX132	7980 lb	5BY132
138"	2410 lb	5BB138	-	-	-	-	-	-	4030 lb	5BN138	-	-	5710 lb	5BX138	7620 lb	5BY138
144"	2220 lb	5BB144	-	-	2240 lb	5BH144	-	-	-	-	4740 lb	5BS144	5500 lb	5BX144	7340 lb	5BY144

NOTE: Beam Capacity is reduced if loading is on the step only, unless beams are stabilized by some form of front to back tie.

\* Clear span is measured from inside frame to inside frame.

\*\* Capacity of beam pairs in pounds is calculated in compliance with RMI Specifications and AISI Standard. Calculations assume uniform load distribution. Beams of 138" and 144" span require a minimum of two (2) Heavy Duty Cross Bars.

# Pallet Rack Beam Accessories

## Cross Bars 7/8" Step Beams

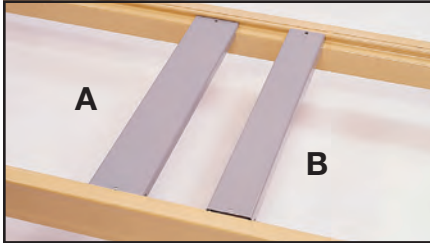

### A. - 1/2" Plywood Support

Supports sheets of 1/2" Plywood.

#### A - 1/2" Plywood Support

Frame Depth	Cat. No.
30"	5AP230C
36"	5AP236C
42"	5AP242C
48"	5AP248C

### B. - General Duty Cross Bar

For supporting loads smaller than unit depth.

#### B - General Duty Cross Bar

Frame Depth	Cat. No.
30"	5AX530C
36"	5AX536C
42"	5AX542C
48"	5AX548C
54"	5AX554C
60"	5AX560C

## Coil Bed

Full depth.  
For proper placement and storage of cylindrical items.



#### Coil Bed

Frame Depth	Cat. No.
30"	5AC030C
36"	5AC036C
42"	5AC042C
48"	5AC048C

## Cross Bars 1-5/8" Step Beams

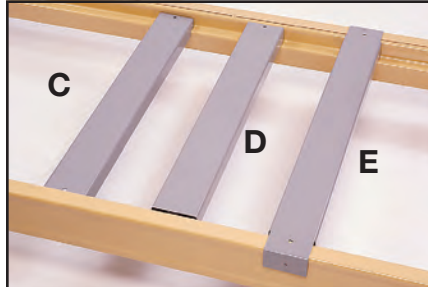

### C. - 3/4" Plywood Support

Supports sheets of 3/4" Plywood.

#### C - 3/4" Plywood Support

Frame Depth	Cat. No.
30"	5AP330
36"	5AP336
42"	5AP342
48"	5AP348
54"	5AP354
60"	5AP360

### D. - General Duty Cross Bar

Supports loads smaller than unit depth on 1-5/8" step beams. Not for plywood.

#### D - General Duty Cross Bar

Frame Depth	Cat. No.
30"	5AX630C
36"	5AX636C
42"	5AX642C
48"	5AX648C
54"	5AX654C
60"	5AX660C

### E. - Heavy Duty Flanged Cross Bar

Supports heavier loads smaller than unit depth on 1-5/8" step beams.

#### E - HD Flanged Cross Bar

Frame Depth	Cat. No.
30"	5AX730C
36"	5AX736C
42"	5AX742C
48"	5AX748C
54"	5AX754C
60"	5AX760C

## Fork Clearance Bar and Heavy Duty Skid Channel

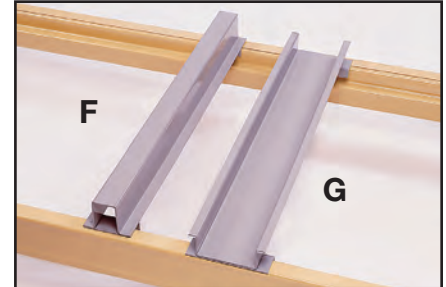

### F. - Fork Clearance Bar

Provides proper fork clearance for un-palletized stock, 2" wide by 2-3/4" high.

#### F - Fork Clearance Bar

Frame Depth	Cat. No.
30"	5AF330C
36"	5AF336C
42"	5AF342C
48"	5AF348C
54"	5AF354C
60"	5AF360C

### G. - Heavy Duty Skid Channel Assembly

Provides a channeled base for skid runners, 4" wide by 2" high.

#### G - HD Skid Channel Assembly

Frame Depth	Cat. No.
30"	5AS230C
36"	5AS236C
42"	5AS242C
48"	5AS248C

### H. - Pallet Stop

Attaches to rear beam with Tek screw. Cat. No. 08822 included. For 1-5/8" step beam only. In Pairs. Cat. No. 5AT00H

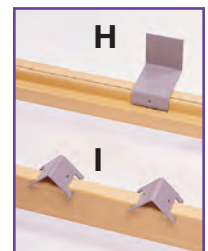

### I. - Drum Wedge

Two loose triangular stops for drum storage. Install on front beam only. In Pairs. Cat. No. 5AW000

# Warehouse Companion Products

## Channel-Lock Safety Grating

### For Multi-Level Shelving, Catwalks & Platforms

Penco shelving has the structural integrity to allow for custom design of multi-level installations in a myriad of configurations. Our Clipper®, Erectomatic®, RivetRite and Wide Span shelving systems along with our Pallet Rack integrate smoothly with multi-level storage situations. Your Penco representative will discuss these options with you to determine which shelving product will work the best with your application.

**Safe.** Penco Safety Grating's standard slip-resistant surface contains hundreds of shoe-gripping nibs formed into the ribs to provide a safe, comfortable walking surface. The open design keeps small debris from accumulating, and allows passage of air and light.

**Strong.** The efficient Channel-Lock design achieves a very high strength-to-weight ratio with double flanges on each rib, and multiple flanges on each side channel for lateral strength. Since each piece is nested in adjacent planks, they actually strengthen one another. Each one-piece rigid plank is manufactured by a continuous roll-forming process capable of producing custom lengths up to 24 feet long.

**Economical.** Easy installation of Penco grating pays off in labor savings. Each plank is light enough for one person to carry. Cutting can be easily done with a hacksaw or power saw. All fastening can be done with standard tools - no welding is required, no special material handling equipment is required.

**The Advantages.** Penco grating is an extremely cost-efficient way to provide an elevated work surface. Its hot dipped galvanized corrosion-resistant coating insures long, safe life for interior or exterior applications.

Penco Channel-Lock Safety Grating is the ideal companion for multilevel installations made from Penco Clipper® or RivetRite® Shelving, or Penco Pallet Rack.

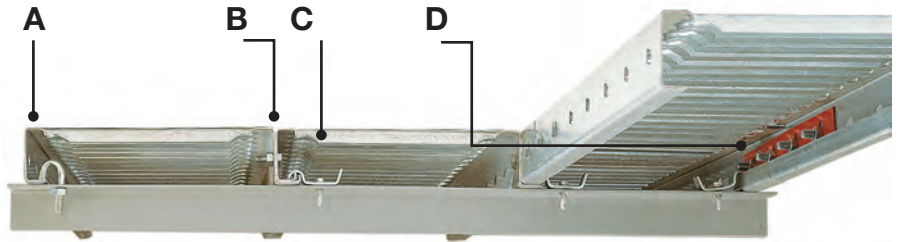

### Grating Accessories

Letter Code	Name	Description	Size	Cat. No.
A	J-Bolt	Bag of 50 - Fastens grating to support structure.	5/16" Dia.	82200
B	Bolts/Nuts	Bag of 50 - hex head bolts & nuts (use 4 per plank)	5/16" x 5/8"	82201
C	Hold Down Clip	Fastens grating to support. Includes self-tapping screw.	-	8HC00H
D	Splice	Holds grating together at outside edge of deck.	12"	8SP012

The grating shown below are the most popular sizes. All are 2" high by 8-7/8" wide, 16 gauge. Other gauges and sizes are available for large applications.

### Most Popular Grating Sizes

Grating Illustration	Grating Name	Application	Length	Cat. No.
	Male/ Female	Interlocks on both sides. Used for most applications.	72"	8AL072C
			108"	8AL108C
			144"	8AL144
	Male/ Male	Interlocks on one side only. For flush fit at edge of deck.	72"	8GL072C
			108"	8GL108C
			144"	8GL144
	Filler	To fill 3" wide gaps.	72"	8FK072C
			108"	8FK108C
			144"	8FK144



### Grating Capacity Table

Measurement	3'	4'	5'	6'	7'	8'	Point Load*	Weight Per Lin. Ft.	Weight Per Sq. Ft.
Uniform Load (U1)	668	374	238	164	119	-			
Deflection (D1)	0.11	0.19	0.29	0.42	0.57	-			
Uniform Load PSF(U2)	668	374	203	116	71	46			
Deflection at Above Load (D2)	0.11	0.19	0.25	0.3	0.35	0.4	110	3.11 lb	4.15 lb

16 gauge x 2" high. Unsupported span in feet. For capacities other than 2" high, 16 ga. grating, contact your local representative.

U1 = Uniform load in pounds per square foot for 9" wide plank (safe stress limit, no restriction on deflection).

D1 = Deflection in inches at load U1.

U2 = Uniform load in pounds per square foot for 9" wide plank (deflection restricted to length/240).

D2 = Deflection in inches at load U2.

\* Point Load = Maximum load in pounds for truck wheels each up to 2" wide by 8" diameter (for other types of concentrated loads, contact your local representative). To convert square feet to 9" wide linear feet: Multiply square feet x 1.35.

To convert 9" wide linear feet to square feet: Multiply linear feet x .74.



# Pallet Rack/Pallet Rack Plus

## Specifications

**PALLET RACK:** The basic components of Standard Penco Pallet Rack are Upright Frames and Beams. Each is manufactured to exacting tolerances to provide many years of dependable service at their rated loads.

**Step Down Design:** All beams have a step for the purpose of accepting accessories. Two step sizes are available: 7/8" and 1-5/8" high.

**Beam Locking Key For Safety:** A unique recessed safety key made from heavy gauge steel engages a slot in the side of the post. As soon as beams are installed, the locking keys should be slid into place. They will resist an upward force from material handling equipment up to 1000 pounds. It is an integral part of the beam assembly, can be engaged easily without tools, and is clearly visible for checking.

**Heavy Duty Beam End Connector:** Beam ends are made from extra heavy gauge steel. They feature a three prong connection which assures positive beam to post alignment along the 8-1/2" length of the connector, and uniform load distribution. Tabs extend along the face of the beam to provide extra protection to the prongs during transit and installation.

**Heavy Duty Beam End Connector (Pallet Rack Plus):** Pallet Rack Plus beams are intended for use in severe conditions or high seismic areas and have four pronged end frame connectors. The beams are centered along the 11 1/2" long connector so all prongs share equally in the live beam load. Any Penco pallet rack beam can be equipped with four-pronged connectors.

**Welded Upright Frame Bracing:** Upright frame columns are securely MIG welded together with channel type braces for maximum rigidity.

**Upright Column:** A continuous post roll formed into an "M" design for added strength. Slanted slots on the column allow for beam placement on 3" vertical centers. The greater the unit load the tighter the beam-upright connection becomes. Slots on column sides accept the safety beam locking key. The design allows for standard beams to be placed flush with the top, or as close as 9" from the floor.

**Upright Column (Pallet Rack Plus):** A continuous post roll formed into an "M" design for added strength. Slanted slots on the column allow for beam placement on 3" vertical centers. The greater the unit load the tighter the beam-upright connection becomes. All Plus pallet rack beams are attached 3" down from the top of the heavy duty connector and cannot be installed flush with the top of the uprights. Plus beams can be placed within 9" above the floor.

**Foot Plate:** A heavy gauge foot plate is securely welded to each post to provide load distribution over 13.7 square inches, and two 9/16" holes allow for floor anchoring on either side of the frame. Standard duty footplates are 7 ga. thick.

**Foot Plate (Pallet Rack Plus):** All pallet rack Plus upright frames have footplates that are 35 square inches and 3/8" thick. Four 9/16" holes are present at the corners for anchoring.

**Pallet Rack Frames:** Penco Pallet Rack Upright Frames are available in five different load carrying ranges. A letter code stamped into the face of the post indicates the frame type. Depths of 30", 36", 42", 48", 54" and 60" are standard, but other depths are available. Standard heights range from 48" to 240" in 6" increments, but greater heights can be achieved when splices are used. Double posted and cantilever leg custom upright configurations are available upon request. Beam heights adjust on 3"

vertical centers, and are independent on each side of the frame. Various load rated frames can be combined in a row of rack for maximum economy. Beams cannot be placed at locations where a splice is positioned. Penco Pallet Rack Upright Frames are furnished completely fabricated, welded into rigid units. Standard finish for upright frames is 028 Gray baked enamel. Other standard Penco colors are available upon request. We recommend that all upright frames be securely anchored to the floor for safety. Seismic conditions and local codes may require anchors other than the Penco 1/2"-13 x 3 3/4" wedge anchor be used. We suggest you check with local code officials about anchoring as many jurisdictions have approved different anchors.

**Pallet Rack Beams:** Penco has engineered its roll-formed one piece beam to achieve the highest possible strength-to-weight ratios in the most frequently desired load ratings through the use of efficient design and high strength steel. Beams are offered in eight basic styles with different vertical profiles and steel gauges. Beam step heights of 7/8" and 1-5/8" are available for a wide variety of accessory use. Both the overlapping seam and the beam end connector are securely MIG welded for strength. The face of the beam has an M-design recessed configuration for added strength, protecting the locking key, and to accept pressure sensitive labeling. Each beam is stamped with an identifying letter referring to the load bearing capacity. Beams are finished in 710 Sagebrush Yellow baked enamel for high visibility. Safety Yellow and any other standard Penco colors are available upon request.

### PALLET RACK ACCESSORIES

**Plywood Supports:** For supporting plywood or other wood decking. Styles are available for 1/2" deck on 7/8" step beams and 3/4" deck on 1-5/8" step beams.

**General Duty Cross Bars:** For supporting loads smaller than unit depth.

**Heavy Duty Flanged Cross Bar:** Supports heavier loads smaller than unit depth on 1-5/8" step beams.

**Fork Clearance Bar:** Provides proper fork clearance for unpalletized stock, 2" wide by 2-3/4" high.

**Heavy Duty Skid Channel Assembly:** Provides a channeled base for skid runners, 4" wide by 2" high.

**Frame Splice:** For adding to height of existing frame. Can be supplied welded in top of new frame if specified on order. (Top frame must be ordered without foot plate.) Hardware provided.

**Frame Protector:** Anchors to floor at front of post. Provides protection against damage from material handling equipment.

**Frame Deflector:** Fastens to front of upright post on 3" increments.

**Rigid Wall Bracket:** Structurally connects racks to wall for additional stability. Frame hardware included.

**Rigid Row Spacer:** Structurally connects and spaces two rows of rack back-to-back to satisfy NFPA requirements. Bolted into place. Hardware included.

**Reel Holder:** Accessorizes rack for elevated reel storage. Capacity is 1,000 lbs./pair and they can hold axels up to 2 1/2" diameter. Hardware included.

**Decking:** Decking for Pallet Rack is available in a number of formats that include wire, steel and wood.

PENCO RESERVES THE RIGHT TO VARY SPECIFICATIONS CONSISTENT WITH A POLICY OF CONTINUOUS PRODUCT IMPROVEMENT.



# WorkSafe™

## QuickShip Barrier Rail



For lead times and warehouse locations, go to:  
[pencoproducts.com/lead-times](http://pencoproducts.com/lead-times)  
[pencoproducts.com/quickship](http://pencoproducts.com/quickship)

### QuickShip Barrier Rail and Posts

Penco's QuickShip Barrier Rail is engineered for strength and durability at an affordable price. Barrier Posts are constructed of a 4" x 4" high-strength ASTM A-36 structural steel on a 10" square x 1/2" thick base plate. The 9.5" high rails are roll formed 11 gauge steel.

Post can be used as a Bollard and flared ends are not available. Protective hard, flat plastic caps are included to close off the top of each post. Anchoring hardware is included. Posts and barrier rail are powder coated in high visibility yellow.

QuickShip Barrier Rail ships in 72 hours from the Philadelphia and Salt Lake City distribution centers.

# WorkSafe™

### QuickShip Barrier Rail

Catalog Number	Length	Weight (lbs.)
BRL-04H	4'	19.2
BRL-05H	5'	24.0
BRL-06H	6'	28.8
BRL-07H	7'	33.5
BRL-08H	8'	38.3
BRL-09H	9'	42.3
BRL-10H	10'	47.9

Note: All barrier rail includes mounting clips and hardware.

### QuickShip Posts

Catalog Number	Description	Height	Weight (lbs.)
PLA-15H	single barrier rail post assembly	15"	26.0
PLA-30H	single or double barrier rail post	30"	38.0
PLA-44H	single, double, or triple barrier rail post assembly	44"	46.0

Note: All posts include plastic cap, concrete floor anchors, and yellow plugs.



# WorkSafe™

## Standard Barrier Rail

Barrier Rail					
Length	Dim. "A"	Dim. "B"	Dim. "C"	Weight (lbs.)	Catalog Number
3'	32"	42"	52"	29.07	<b>WBR3C007</b>
4'	44"	54"	64"	37.65	<b>WBR4C007</b>
5'	56"	66"	76"	46.23	<b>WBR5C007</b>
6'	68"	78"	88"	54.81	<b>WBR6C007</b>
7'	80"	90"	100"	63.39	<b>WBR7C007</b>
8'	92"	102"	112"	71.97	<b>WBR8C007</b>
9'	104"	114"	124"	80.55	<b>WBR9C007</b>
10'	116"	126"	136"	89.13	<b>WBR10C007</b>

Barrier Rail Heights	
	Top of Rail Height from Floor
1st Rail	1'1-3/8"
2nd Rail	2'23-7/8"
3rd Rail	3'6-3/8"

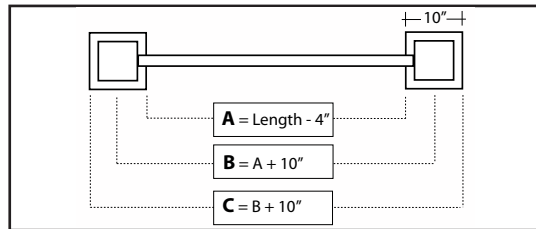

Barrier Rail Options			
Description	Weight (lbs.)	Catalog Number	
pair of barrier rail pockets for lift-out rails	14.77	<b>WBRPC007</b>	
flared end for 15" high post	9.76	<b>WFE-13C007</b>	
flared end for 30" high post	21.02	<b>WFE-28C007</b>	
flared end for 44" high post	31.53	<b>WFE-42C007</b>	

Posts			
Description	Height	Weight (lbs.)	Catalog Number
single barrier rail post	15"	32.86	<b>WP15HC007</b>
single or double barrier rail post	30"	51.06	<b>WP30HC007</b>
single, double, or triple barrier rail post	44"	69.27	<b>WP44HC007</b>
6" x 6" black, plastic cap		0.50	<b>W78605</b>

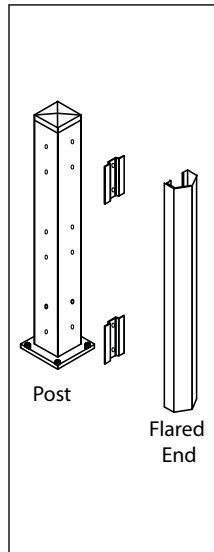

### Barrier Rail

Penco's unique Barrier Rail is constructed of high-strength ASTM A-36 structural steel, providing the added safety that cold-rolled steel products simply can't deliver. Posts are 6" x 6" structural steel tube on a 10" square x 1/2" thick base plate.

The Barrier Rail is designed to protect against a 10,000 lb. load at 4 mph. For added protection, all posts also come with protective plastic caps to eliminate sharp edges.

Barrier Rail and Posts include hardware kits.

# WorkSafe™



### Guide Rail

Protect traffic aisle ways from forklift damage with rugged 3/8" guide rail angle units with pre-drilled mounting holes. Anchoring hardware is included.

The standard size for guide rail is 4" x 3" x 3/8" with a standard length of 10' - 17', unless otherwise specified. Larger angle is available. Schmidt guide rail is available in lengths of up to 20'.



Guide Rail		
Length	Weight (lbs.)	Catalog Number
3'	26.47	WGR03HC007
4'	35.29	WGR04HC007
5'	44.11	WGR05HC007
6'	52.93	WGR06HC007
7'	61.75	WGR07HC007
8'	70.57	WGR08HC007

Guide Rail Ends		
	Weight (lbs.)	Catalog Number
left hand	11.76	WGR30LHC007
right hand	11.76	WGR30RHC007

### Rack End Protectors

Heavy duty formed 6" x 3/8" steel plate with integral round 1/4" post protector, anchoring hardware is included.



Rack End Protectors			
Length	Left Hand/Right Hand	Weight (lbs.)	Catalog Number
3'	left hand	24.53	WREP3LHC007
3'	right hand	24.53	WREP3RHC007
4'	left hand	32.00	WREP4LHC007
4'	right hand	32.00	WREP4RHC007
5'	left hand	39.47	WREP5LHC007
5'	right hand	39.47	WREP5RHC007
6'	left hand	46.94	WREP6LHC007
6'	right hand	46.94	WREP6RHC007
7'	left hand	54.41	WREP7LHC007
7'	right hand	54.41	WREP7RHC007
8'	left hand	61.88	WREP8LHC007
8'	right hand	61.88	WREP8RHC007

# WorkSafe™

### Column and Pallet Rack Post Protectors

Constructed of 1/4" steel plate with four (4) anchoring feet in three standard heights, complete with anchoring hardware.

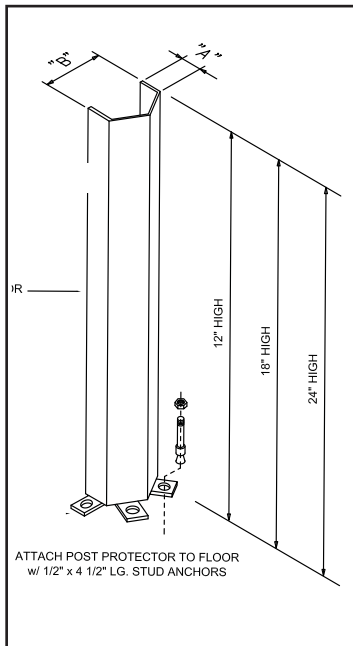

### Column and Pallet Rack Post Protector

Height	Depth ("A")	Width ("B")	Weight (lbs.)	Catalog Number
12"	3"	4"	11.45	WPP1234HC007
12"	3"	6"	14.45	WPP1236HC007
12"	4"	9"	19.36	WPP1249HC007
12"	5"	11"	23.30	WPP12511HC007
12"	6"	13"	26.95	WPP12613HC007
18"	3"	4"	16.47	WPP1834HC007
18"	3"	6"	20.52	WPP1836HC007
18"	4"	9"	27.91	WPP1849HC007
18"	5"	11"	33.82	WPP18511HC007
18"	6"	13"	39.29	WPP18613HC007
24"	3"	4"	21.49	WPP2434HC007
24"	3"	6"	26.60	WPP2436HC007
24"	4"	9"	36.46	WPP2449HC007
24"	5"	11"	44.34	WPP24511HC007
24"	6"	13"	51.64	WPP24613HC007

# WorkSafe™

## Bollards and Guards

Bollards		
Height	Weight (lbs.)	Catalog Number
15"	32.86	WB26HC007
30"	51.07	WB30HC007
44"	69.27	WB44HC007
6" x 6" black plastic cap		W78605

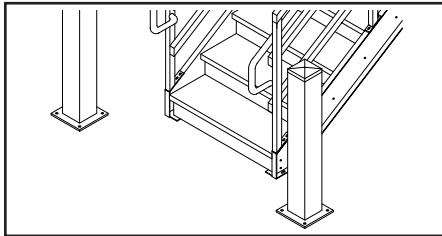

### Bollards

Easy floor mount units-no concrete work needed. Instant protection from aiseways, doors and equipment. Bollards are 6" square x 1/4" steel units and are A500 Grade B with yield strength of 46,000 psi on a 10" x 10" base plate. All bollards also come with protective plastic caps to eliminate sharp edges and are available in three (3) heights. Anchoring hardware is included.

Sprinkler Guards		
Length	Weight (lbs.)	Catalog Number
1'	7.24	WPSX12HC007
1'-6"	8.42	WPSX18HC007
2'	9.60	WPSX24HC007
2'-6"	11.12	WPSX30HC007
3'	12.30	WPSX36HC007
3'-6"	13.82	WPSX42HC007
4'	15.00	WPSX48HC007



### Sprinkler Guards

Commonly installed between racking system, sprinkler guards attach to the top of the racks themselves and protect the sprinklers that run between the racks. Also, the guards can be mounted to mezzanines by attaching them to the deck beams. Strong 5/8" diameter hot-rolled bar stocked with welded 1/4" mounting plates, sprinkler guards can be fabricated as short as 10" up to 5' lengths.

Overhead Door Track Guards				
Catalog Number	Height	Width	Depth	Weight
WDG24HC007	2'	5'3/4"	6'1/4"	21.31 lbs.
WDG48HC007	4'	5'3/4"	6'1/4"	42.63 lbs.

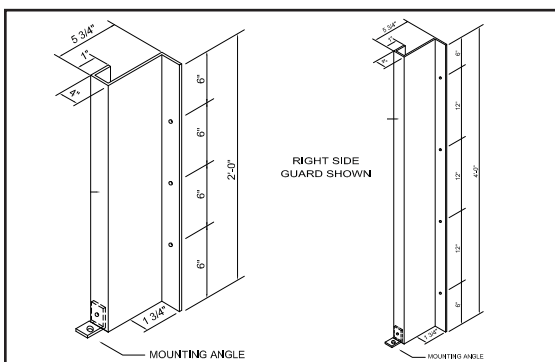

### Overhead Door Track Guards

Guards encase door tracks to protect against damage from skids or pallet jacks.

Easy to install units to protect overhead door operation. Fabricated with rugged 1/4" steel plate, these dock door protectors come complete with floor mounting and wall mounting hardware.

# WorkSafe™

# Lockers

## Introduction

Penco has been building lockers for decades that last for decades and has become a part of the fabric of American life. Look in any school and chances are you'll find Penco's lockers in the athletic department, field house, faculty break room and of course, lining the corridors.

School lockers may be Penco's foundation, but the spectrum of products doesn't end there. Penco has locker solutions for recreation centers, health clubs, hospitals, back office and industry break rooms, while at the same time delivering the widest range of solutions to serve first responders in the military, law enforcement and fire and rescue professions.

Locker specifications can be found in the Penco Lockers catalog or on [pencoproducts.com](http://pencoproducts.com).

### Terms Used in This Catalog

**KD:** Knocked Down, or lockers that are shipped unassembled for assembly and installation at their destination.

**GA:** Gauge of steel - indicates the thickness. The lower the number the thicker the steel.

**LH & RH:** Left Hand and Right Hand side of a locker, as seen standing in front of a locker.

**Tier:** A "level" of a locker defined by the number of doors in a vertical row. This can range from 1 to 9 tiers.

**Opening & Frame:** Opening is what is behind a door. A frame is the unit that holds the doors. There can be multiple doors per frame.

**Double Row:** "Back-to-back" lockers.

**Double Door Locker:** A locker with two full length doors that open in the center.

**W, D & H:** Width, Depth & Height dimensions (inches).

Single Tier Lockers include a shelf

Classic III Recessed Handle

Continuous Hinge, available on all lockers (except QuickShip lockers)

Standard full-loop 5-knuckle design hinge

Vanguard Die-Cast Handle

Defiant II Single Point Latch

Friction Catch Door Pull



Vanguard Single Tier

Guardian Double Tier

Invincible II Triple Tier

Invincible II Six Tier

NOTE: All-Welded, Angle Iron, Stadium and Patriot lockers are not shown above.



# Lockers

## Construction Variations

### Ventilation Options

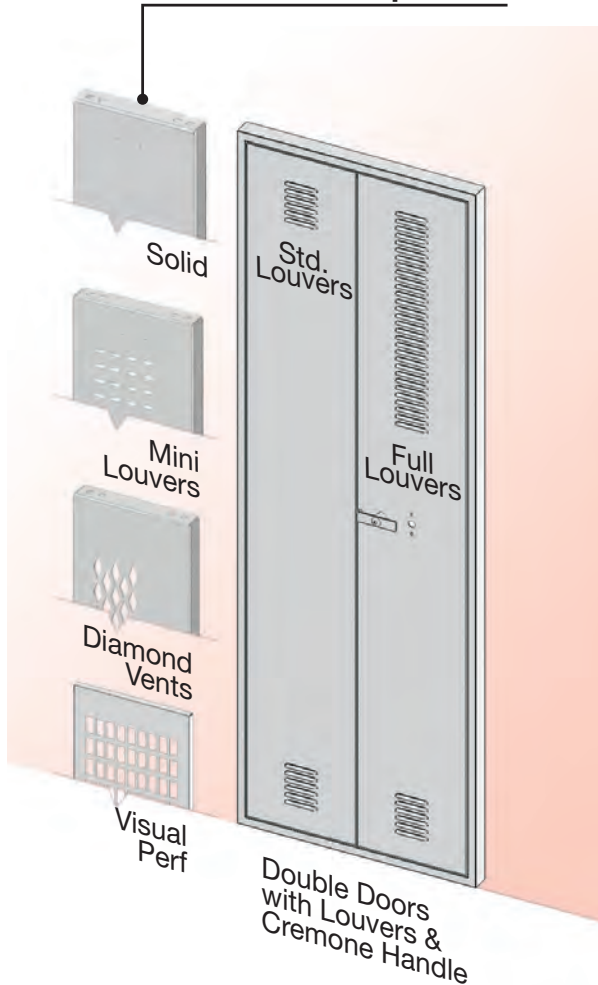

#### Cremone Multi-Point Handle.

An unbreakable steel handle securely bolted to a 3 point latching system.

A 3/8" diameter latching rod engages at the top and bottom of the door frame. A 1/8" thick center latch locks the center of the door to the frame. The cremone handle is available on a variety of KD and welded heavy duty locker doors; it is standard on Patriot Gear and Duty lockers.

3 views at right: top, middle and bottom of inside of door with cremone handle.



### Handles & Latching



**Die-Cast Handle.** This patented die-cast handle opens multi-point latch lockers with one simple motion. Standard on 1, 2 & 3 tier, 2-Person and Duplex Vanguard lockers.



**Automatic Multi-Point Latching.** Allows the door to be closed without locking. Standard on all multi-point doors except box lockers, Single Point Latch doors and Cremone Handle lockers.



#### Classic III Stainless Steel Recessed Handle.

Seamless deep drawn design is attractive as well as strong. Utilizes the Automatic Multi-Point Latching feature.



Standard on all 1, 2 & 3 tier 2-Person and Duplex, Vanguard Recessed, Guardian & Guardian PLUS lockers. Also standard on Invincible II and All-Welded 1, 2 and 3 tier lockers. This is the preferred handle for ADA lockers.



**Defiant II Single Point Latch.** Stainless steel deep drawn pocket with no moving parts (single point latch). Used with a vertical or horizontal pan welded to door. Standard on 1, 2 and 3 tier Defiant II Locker models.



**Anti Pry Lug.** Defeats prying attempts by capturing the door flange and preventing separation from the door channel.

See Defiant II details on page 88.

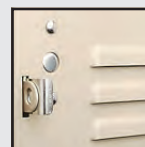

#### Friction Catch Door Pull.

All box lockers come standard with this friction catch door pull handle with padlock hasp.



**Spring Loaded Positive Latch.** This latch, also known as a "Slam Latch", is available as an option on heavy duty box lockers.

# Vanguard™ Steel Lockers

## At a Glance

- Knock Down Construction
- Standard louvers for ventilation
- Classic III handle standard on QuickShip multi-point latch models
- 24 ga. body painted to match door frame
- Many sizes available through QuickShip

## Ventilation Options



Standard Louvers (S)



Full Louvers (O)



Mini Louvers (O)



Solid Door (O)

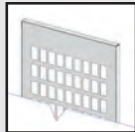

Visual Perf (O)

## Door Handle Options



Die-Cast (S)



Classic III Recessed (O)



Friction Catch (SB)

S = Standard  
O = Optional\*

SB = Standard on Box Lockers



Vanguard™

The Vanguard line is the embodiment of what it takes to withstand the daily use and abuse typically dealt to a locker. The powder coat baked enamel finish is extremely durable, and body parts are finished the same color as the doors, as standard. Each latch hook features a noise-reducing rubber bumper for quieter operation.

The welded door frames have mortise and tenon construction and are spot welded for lifetime rigidity. Every door has a continuous door strike. All hinges are full loop, 5-knuckle design.

Larger Vanguard locker doors have a multi-point latch that holds the door closed securely in 2 or 3 locations. Lockers with multi-point latches are available with either a die-cast pull-out handle or a Classic III stainless steel recessed pocket handle. Smaller 'box locker' doors have friction catch door pulls. All handles accept locks, which are ordered separately.

The Vanguard line has more variations than any other Penco locker type. The catalog numbers for the first group shown below are on the following page. All production Vanguard lockers are available in 24 colors. Quick shipment from stock is available from multiple warehouses for our most popular models and sizes in 2 colors (see pages 58-59).

Vanguard lockers perform many jobs. The 16-Person locker is 69" W x 18" D x 78" H (with legs) and stores personal belongings of 16 people plus space for hangers. Our Wall Mount locker has 4 compartments and is 45" W x 18" D x 13-5/8" H and can be set on counters (without coat rod).

The 'Executive' locker can be custom outfitted in a number of ways for spacious storage. Accessories can include lockable inner compartment, extra shelves, combination comb & brush tray with towel bar, golf ball tray and acrylic mirror. Dual lockers have a vertical partition to separate the interior below the shelf into two sections and can be made from most 15" or 18" W x 18" or 21" D 1-tier lockers.

Where space is tight, Half Height lockers (30.5", 36.5" or 48.5" H and 12", 15" or 18" D) often will do the job. The 48.5" high models have an interior shelf. 1 Tier Box lockers (12" W x 13-5/8" H x 12, 15 or 18" D) can provide mini-storage.

Box Over Lockers (see next page) have an independent lockable box locker door above a 60" standard door. If a shelf is required in the lower compartment, it must be ordered separately.

For multiple-user applications such as gym locker rooms, 7 and 8 Person lockers make the most use of space (next page). The box compartments (18" W x 12" H) are for permanent storage of athletic gear. When a user is present, the large locker (18"W x 60"H) is used for street clothes.

\*additional charges may apply



1 Tier    2 Tier    3 Tier    4 Tier    5 Tier    6 Tier    2 Person    Duplex



16 Person (No. 6579V)    The Executive    Dual    Half Height & 1 Tier Box (No. 68242)



# Vanguard™

## Sizes and Dimensions

Vanguard 1, 2 & 3 Tier Lockers															
		1 Tier				2 Tier						3 Tier			
Overall Height*		60"	72"	60"	72"	60"	72"	84"	60"	72"	84"	60"	72"	60"	72"
Opening Height*		60"	72"	60"	72"	30"	36"	42"	30"	36"	42"	20"	24"	20"	24"
Width	Depth	Die-Cast Handle		Classic III Handle		Die-Cast Handle			Classic III Handle			Die-Cast Handle		Classic III Handle	
9"	12"	6101V	6151V	6101R	6151R	6201V	6221V	-	6201R	6221R	-	-	-	6401R	6413R
	15"	6103V	6153V	6103R	6153R	6203V	6223V	-	6203R	6223R	-	-	-	6403R	6415R
	18"	6105V	6155V	6105R	6155R	6205V	6225V	-	6205R	6225R	-	-	-	6405R	6417R
12"	12"	6111V	6161V	6111R	6161R	6211V	6231V	6251V	6211R	6231R	6251R	6407V	6419V	6407R	6419R
	15"	6113V	6163V	6113R	6163R	6213V	6233V	6253V	6213R	6233R	6253R	6409V	6421V	6409R	6421R
	18"	6115V	6165V	6115R	6165R	6215V	6235V	6255V	6215R	6235R	6255R	6411V	6423V	6411R	6423R
	21"	6117V	6167V	6117R	6167R	6217V	6218V	-	6217R	6218R	-	6449V	-	6449R	6499R
15"	12"	6118V	6168V	6118R	6168R	6200V	6220V	-	6200R	6220R	-	-	-	-	-
	15"	6119V	6179V	6119R	6169R	6227V	6239V	-	6227R	6239R	-	-	6472V	-	6472R
	18"	6121V	6171V	6121R	6171R	6229V	6241V	6261V	6229R	6241R	6261R	-	6494V	-	6494R
	21"	6123V	6173V	6123R	6173R	6237V	6243V	6263V	6237R	6243R	6263R	-	6496V	-	6496R
18"	15"	6125V	6175V	6125R	6175R	6257V	6245V	-	6257R	6245R	-	-	-	-	-
	18"	6126V	6177V	6126R	6177R	6258V	6246V	-	-	6246R	-	-	-	-	-
	21"	6134V	6180V	6134R	6180R	-	6259V	-	-	6259R	-	-	-	-	-
	24"	6131V	6181V	6131R	6181R	-	6247V	-	-	6247R	-	-	-	-	-
24"	15"	6133V	6183V	6133R	6183R	-	6249V	-	-	6249R	-	-	-	-	-
	18"	6135V	6185V	6135R	6185R	-	6250V	-	-	6250R	-	-	-	-	-
	21"	6149V	6196V	6149R	6196R	-	-	-	-	-	-	-	-	-	-
	24"	6158V	6198V	6158R	6198R	-	-	-	-	-	-	-	-	-	-
24"	18"	6160V	6199V	6160R	6199R	-	6274V	-	-	6274R	-	-	-	-	-

Vanguard 2 Person and Duplex Lockers									
		2 Person				Duplex			
Overall Height*		60"	72"	60"	72"	60"	72"	60"	72"
Width	Depth	Die-Cast Handle		Classic III Handle		Die-Cast Handle		Classic III Handle	
15"	12"	6510V	6500V	6510R	6500R	-	-	-	-
	15"	6506V	6501V	6506R	6501R	6519V	6531V	6519R	6531R
	18"	6437V	6503V	6437R	6503R	6521V	6533V	6521R	6533R
	21"	-	6505V	-	6505R	-	6535V	-	6535R
18"	15"	-	6509V	-	6509R	-	-	-	-
	18"	-	6515V	-	6515R	-	-	-	-
	21"	-	6525V	-	6525R	-	-	-	-

\* All dimensions are in inches. Overall Height is the overall height of the locker frame, NOT including legs. Opening Height is the nominal height of the individual door opening. Opening Height for 2 Person Lockers: for 60" high models, bottom doors are nominal 42" high; for 72" high models, bottom doors are nominal 54" high. Book compartment doors are nominal 9" high each.

Vanguard Box Lockers - 3, 4, 5 & 6 Tier								
		3 Tier		4 Tier		5 Tier		6 Tier
Overall Ht.*		60"	72"	60"	72"	60"	72"	72"
Opening Ht.*		20"	24"	15"	18"	12"	14-2/5"	12"
Width	Depth	Cat. No.	Cat. No.	Cat. No.	Cat. No.	Cat. No.	Cat. No.	Cat. No.
9"	12"	6301V	6313V	-	-	-	-	-
	15"	6303V	6315V	-	-	-	-	-
	18"	6305V	6317V	-	-	-	-	-
12"	12"	6307V	6319V	6325V	6331V	6343V	6353V	6365V
	15"	6309V	6321V	6327V	6337V	6345V	6355V	6367V
	18"	6311V	6323V	6329V	6339V	6347V	6357V	6369V
	21"	6349V	6399V	6393V	6395V	-	6435V	6371V
15"	12"	-	6372V	-	-	-	-	6363V
	15"	-	6394V	6333V	6431V	6351V	6359V	6373V
	18"	-	6396V	-	6433V	6397V	6361V	6375V
	21"	-	-	-	-	-	-	6377V
18"	18"	-	6335V	-	-	-	-	6379V
	21"	-	-	-	-	-	-	6378V



Box Over

Box Over Lockers - 72" High		
Unit Width	Unit Depth	Cat. No.
12"	12"	6439V
12"	15"	6441V
12"	18"	6443V
15"	15"	6436V
18"	18"	6445V
18"	21"	6447V



7 Person

7 Person Locker			
Width	Depth	Height	Cat. No.
36"	18"	72"	6573V
36"	21"	72"	6575V

8 Person Locker			
Width	Depth	Height	Cat. No.
54"	18"	72"	6577V



8 Person

# Vanguard™ QuickShip Lockers



For lead times and warehouse locations, go to:  
[pencoproducts.com/lead-times](http://pencoproducts.com/lead-times)  
[pencoproducts.com/quickship](http://pencoproducts.com/quickship)

## QuickShip Vanguard 1 Tier

Grp.	Illustration	Width	Depth	Opn.Ht.*	028 Gray	073 Champagne
1-Wide		12" 12" 60"	12"	60"	68001R028	68001R073
		12" 15" 60"	15"	60"	68011R028	68011R073
		12" 18" 60"	18"	60"	68021R028	68021R073
		12" 12" 72"	12"	72"	68051R028	68051R073
		12" 15" 72"	15"	72"	68061R028	68061R073
		12" 18" 72"	18"	72"	68071R028	68071R073
		15" 18" 72"	15"	18"	72"	68091R028
18" 18" 72"	18"	18"	72"	68101R028	68101R073	
2-Wide		12" 12" 60"	12"	60"	68002R028	68002R073
		12" 15" 60"	15"	60"	68012R028	68012R073
		12" 18" 60"	18"	60"	68022R028	68022R073
		12" 12" 72"	12"	72"	68052R028	68052R073
		12" 15" 72"	15"	72"	68062R028	68062R073
		12" 18" 72"	18"	72"	68072R028	68072R073
		15" 18" 72"	15"	18"	72"	68092R028
18" 18" 72"	18"	18"	72"	68102R028	68103R073	
3-Wide		12" 12" 60"	12"	60"	68003R028	68003R073
		12" 15" 60"	15"	60"	68013R028	68013R073
		12" 18" 60"	18"	60"	68023R028	68023R073
		12" 12" 72"	12"	72"	68053R028	68053R073
		12" 15" 72"	15"	72"	68063R028	68063R073
		12" 18" 72"	18"	72"	68073R028	68073R073
		15" 18" 72"	15"	18"	72"	68093R028
18" 18" 72"	18"	18"	72"	68103R028	68103R073	

## QuickShip Vanguard 2 Tier

Grp.	Illustration	Width	Depth	Opn.Ht.*	028 Gray	073 Champagne	
1-Wide		12" 12" 30"	12"	30"	68111R028	68111R073	
		12" 12" 36"	12"	36"	68121R028	68121R073	
		12" 15" 36"	15"	36"	68131R028	68131R073	
		12" 18" 36"	18"	36"	68141R028	68141R073	
		15" 18" 36"	15"	18"	36"	68261R028	68261R073
2-Wide		12" 12" 30"	12"	30"	68112R028	68112R073	
		12" 12" 36"	12"	36"	68122R028	68122R073	
		12" 15" 36"	15"	36"	68132R028	68132R073	
		12" 18" 36"	18"	36"	68142R028	68142R073	
3-Wide		15" 18" 36"	15"	18"	36"	68262R028	68262R073
		12" 12" 30"	12"	30"	68113R028	68113R073	
		12" 12" 36"	12"	36"	68123R028	68123R073	
		12" 15" 36"	15"	36"	68133R028	68133R073	
		12" 18" 36"	18"	36"	68143R028	68143R073	
15" 18" 36"	15"	18"	36"	68263R028	68263R073		

## QuickShip Vanguard 3 Tier

Grp.	Illustration	Width	Depth	Opn.Ht.*	028 Gray	073 Champagne
1-Wide		12" 12" 24"	12"	24"	68331R028	68331R073
		12" 15" 24"	15"	24"	68341R028	68341R073
		12" 18" 24"	18"	24"	68351R028	68351R073
2-Wide		12" 12" 24"	12"	24"	68332R028	68332R073
		12" 15" 24"	15"	24"	68342R028	68342R073
		12" 18" 24"	18"	24"	68352R028	68352R073
3-Wide		12" 12" 24"	12"	24"	68333R028	68333R073
		12" 15" 24"	15"	24"	68343R028	68343R073
		12" 18" 24"	18"	24"	68353R028	68353R073

## For lockers in a hurry!

- KD lockers ship in 72 hours
- Many QuickShip accessories are available (see next pages)
- Assembly available by request
- Number plates included
- 1, 2 and 3-Wide groupings
- 1, 2 and 3 tier models have recessed handles
- 6" legs standard (available with no legs by request)

## QuickShip Vanguard 5 Tier

Grp.	Illustration	Width	Depth	Opn.Ht.*	028 Gray	073 Champagne
1-Wide		12" 12" 12"	12"	12"	68161X028	68161X073
		12" 15" 12"	15"	12"	68171X028	68171X073
2-Wide		12" 12" 12"	12"	12"	68162X028	68162X073
		12" 15" 12"	15"	12"	68172X028	68172X073
3-Wide		12" 12" 12"	12"	12"	68163X028	68163X073
		12" 15" 12"	15"	12"	68173X028	68173X073

## QuickShip Vanguard 6 Tier

Grp.	Illustration	Width	Depth	Opn.Ht.*	028 Gray	073 Champagne
1-Wide		12" 12" 12"	12"	12"	68191X028	68191X073
		12" 15" 12"	15"	12"	68201X028	68201X073
		12" 18" 12"	18"	12"	68211X028	68211X073
2-Wide		12" 12" 12"	12"	12"	68192X028	68192X073
		12" 15" 12"	15"	12"	68202X028	68202X073
		12" 18" 12"	18"	12"	68212X028	68212X073
3-Wide		12" 12" 12"	12"	12"	68193X028	68193X073
		12" 15" 12"	15"	12"	68203X028	68203X073
		12" 18" 12"	18"	12"	68213X028	68213X073

## QuickShip Vanguard Specialty Lockers

### 16 Person

Illustration	Width	Depth	Frame Ht.*	028 Gray	073 Champagne
	69"	18"	72"	68231X028	68231X073

### Wall Mount

	45"	18"	13-5/8"	68242X028	68242X073
--	-----	-----	---------	-----------	-----------

\* Height shown is the nominal opening height for 1 through 6 tier, and overall frame height for others, not including 6" legs which are standard on all except the Wall Mount Locker. Width is the nominal outside dimension for 1 frame.

\*\* Shaded area in illustrations indicates the unit of sale; i.e. Cat. No. 68003R028 is for one frame of a 12" x 12" x 60" 1 tier locker, but since it is packaged in a group of 3, it must be ordered in multiples of 3.

# Vanguard™

## QuickShip Locker Accessories

### QuickShip Slope Top Kits

1- Wide					
	Width	Depth	Height	028 Gray	073 Champagne
	12"	12"	4	60229H028	60229H073
	12"	15"	5	60231H028	60231H073
	12"	18"	6	60233H028	60233H073
	15"	18"	6	60239H028	60239H073
	18"	18"	6	60243H028	60243H073

3-Wide					
	Width	Depth	Height	028 Gray	073 Champagne
	12"	12"	4	60230H028	60230H073
	12"	15"	5	60232H028	60232H073
	12"	18"	6	60234H028	60234H073
	15"	18"	6	60240H028	60240H073
	18"	18"	6	60244H028	60244H073

### QuickShip Locker Bases, 6" High

Front Bases					
	Width	Depth	Height	028 Gray	073 Champagne
	12"		6	60217-028	60217-073
	15"		6	60218-028	60218-073
	18"		6	60219-028	60219-073

End Bases					
	Width	Depth	Height	028 Gray	073 Champagne
		12"	6	60204-028	60204-073
		15"	6	60205-028	60205-073
		18"	6	60206-028	60206-073

### QuickShip Fillers

Vertical Angles					
	Width	Depth	Height	028 Gray	073 Champagne
	12"	-	60"	66113-028	66113-073
	12"	-	66"	661221-028	661221-073
	12"	-	72"	661141-028	661141-073
	12"	-	78"	66116-028	66116-073

Wall Angles (Slip Joint)					
	Width	Depth	Height	028 Gray	073 Champagne
	-	-	60"	66118-028	66118-073
	-	-	66"	66120-028	66120-073
	-	-	72"	66119-028	66119-073
	-	-	78"	66121-028	66121-073

Flat Top Fillers (Overlaps Standard Tops)					
	Width	Depth	Height	028 Gray	073 Champagne
	15"	12"	-	661321C028	661321C073
	15"	15"	-	661322C028	661322C073
	15"	18"	-	661323C028	661323C073

Flat Top Corner Fillers					
	Width	Depth	Height	028 Gray	073 Champagne
	12"	12"	-	66138-028	66138-073
	15"	15"	-	66139-028	66139-073
	18"	18"	-	66140-028	66140-073

Slope Top Fillers					
	Width	Depth	Height	028 Gray	073 Champagne
	15"	12"	-	661371-028	661371-073
	15"	15"	-	661372-028	661372-073
	15"	18"	-	661373-028	661373-073

Slope Top Corner Fillers					
	Width	Depth	Height	028 Gray	073 Champagne
	12"	12"	-	66100-028	66100-073
	15"	15"	-	66101-028	66101-073
	18"	18"	-	66102-028	66102-073

This is a partial overview of available accessories through QuickShip. Consult a Penco representative for a complete list.

### QuickShip Locker Room Benches & Accessories

	Width	Depth	Height	Cat. No.	Description
<b>Hardwood Bench Tops</b>					
	36"	9-1/2"	1-1/4"	9611	Finished with clear lacquer. Use 2 pedestals per bench through 96".
	48"	9-1/2"	1-1/4"	9600	
	72"	9-1/2"	1-1/4"	9602	
	96"	9-1/2"	1-1/4"	9604	

Steel Tube Heavy Duty Pedestals					
	Width	Depth	Height	Cat. No.	Description
	028 Gray		16-1/4"	60822H028	Includes hardware to mount to bench. Pedestal must be anchored to floor for safety - see concrete floor anchor.
	073 Champagne		16-1/4"	60822H073	

Stainless Steel Pedestal					
	Width	Depth	Height	Cat. No.	Description
	-		16-1/4"	60827H	Includes hardware to fasten to bench. See non-skid kit below.

Non-Skid Pedestal Kit for Stainless Pedestal					
	Width	Depth	Height	Cat. No.	Description
	-		-	68420	Set of 4 rubber feet and hardware for Stainless Steel Pedestals. Order 1 set per pedestal.

Concrete Floor Anchor 1/4" Diameter					
	Width	Depth	Height	Cat. No.	Description
	-		2"	9680	

### ADA Benches/Bracket/Shelves/Logo

Hardwood Benches for ADA Applications					
	Width	Depth	Height	Cat. No.	Description
	48	18	1-1/4"	9628	These benches are used with the Bench Bracket (below).
	48	24	1-1/4"	9623	

Bench Bracket for ADA Bench - 073 Champagne					
	Width	Depth	Height	Cat. No.	Description
	-	20	20	6ACXHP61H073	To provide back support with 18" bench and 24" seat.

ADA Logo Label					
	Width	Depth	Height	Cat. No.	Description
	-	-	-	8690	

Locker Shelves for ADA Applications						
	Width	Depth	Height	028 Gray	073 Champagne	Description
	12	12	-	60400-028	60400-073	Extra shelves must be installed in the field - may require drilling.
	12	15	-	60402-028	60402-073	
	12	18	-	60404-028	60404-073	
	15	18	-	60408-028	60408-073	
	18	18	-	60412-028	60412-073	

### QuickShip Zee Bases (949 Black)

Illustration	Width	Depth	Height	Cat. No.
	<b>Front Zee Base (14 Ga.)</b>			
	72"	-	4	66700H949
	<b>Splice/End Base</b>			
	-	12"	4	66701H949
	-	15"	4	66702H949
	-	18"	4	66703H949
	<b>Zee Inside Corner Splice</b>			
	-	-	4	66709H949
	<b>Rear Leg (for use with 4" H Zee)</b>			
	-	-	13"	60092-949

# Guardian™

## Steel Lockers

### At a Glance

- Knock Down Construction
- Standard solid 16 ga. door and Classic III handle
- 14 ga. door available
- Optional Defiant II single point latching

### Ventilation Options



Solid Door (S)



Standard Louvers (O)



Full Louvers (O)



Mini Louvers (O)



Diamond Shaped (A)

### Door Options

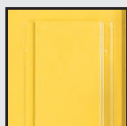

Medallion (O)

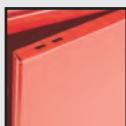

Guardian PLUS (A)

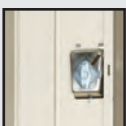

Guardian Defiant II (A)

### Door Handle Options

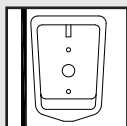

Classic III Recessed (S)

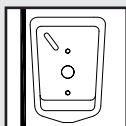

Defiant II Recessed (A)

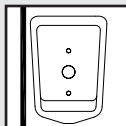

Defiant II Rotary Recessed (A)

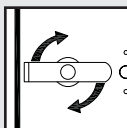

Cremone Turn Handle  
(A - On most Guardian "Plus" models)

S = Standard  
O = Optional\*

A = Available with 14 gauge door only\*  
\*additional charges may apply

# GUARDIAN™

Specifications can be found in the Penco Lockers catalog or on [pencoproducts.com](http://pencoproducts.com).



**Standard Guardian** lockers build upon the design features of the Vanguard series with several enhancements and options that give it a distinctive look.

Our one piece deep drawn Classic III stainless steel recessed pocket is part of every Guardian. It eliminates protrusions from the locker front and accepts a padlock or a built-in lock.

The 16 gauge door front has a solid exterior, aiding quiet operation. Ventilation is achieved by slots in the top and bottom flanges of the door.

**Medallion Option:** This upgrade has a sound damping panel welded to the door reducing noise levels when doors are slammed.

**Guardian PLUS:** This upgrade increases the thickness of the door to 14 gauge. The Guardian PLUS locker is ideally suited for corridors and situations where the locker is likely to encounter harsher than normal usage.

**Guardian Defiant II:** This combines a 14 gauge door with a single point latch stainless steel pocket and a reinforcing pan that stiffens the door. See page 96 for more information.



1 Tier



2 Tier



3 Tier



2 Person



Duplex

# Guardian™

## Sizes and Dimensions

### Guardian 1 Tier Lockers

		Standard Door 16 ga.*		Medallion Door 16 ga.*		Guardian PLUS 14 ga.		Defiant II Latch- 14 ga.	
Opening Height		60"	72"	60"	72"	60"	72"	60"	72"
Width	Depth	Cat. No.	Cat. No.	Cat. No.	Cat. No.	Cat. No.	Cat. No.	Cat. No.	Cat. No.
9"	12"	6101G	6151G	6101M	6151M	6C101	6C151	-	-
	15"	6103G	6153G	6103M	6153M	6C103	6C153	-	-
	18"	6105G	6155G	6105M	6155M	6C105	6C155	-	-
12"	12"	6111G	6161G	6111M	6161M	6C111	6C161	6E111	6E161
	15"	6113G	6163G	6113M	6163M	6C113	6C163	6E113	6E163
	18"	6115G	6165G	6115M	6165M	6C115	6C165	6E115	6E165
	21"	6117G	6167G	6117M	6167M	6C117	6C167	6E117	6E167
	24"	6144G	6168G	-	6168M	6C144	6C168	-	-
15"	12"	6119G	6169G	6119M	6169M	6C119	6C169	6E119	6E169
	15"	6121G	6171G	6121M	6171M	6C121	6C171	6E121	6E171
	18"	6123G	6173G	6123M	6173M	6C123	6C173	6E123	6E173
	21"	6125G	6175G	6125M	6175M	6C125	6C175	6E125	6E175
18"	18"	6131G	6181G	-	6181M	6C131	6C181	6E131	6E181
	21"	6133G	6183G	-	6183M	6C133	6C183	6E133	6E183
	24"	6135G	6185G	-	6185M	6C135	6C185	6E135	6E185

### Guardian 2 Tier Lockers

		Standard Door 16 ga.*		Medallion Door 16 ga.*		Guardian PLUS 14 ga.		Defiant II Latch - 14 ga.	
Overall Height		60"	72"	60"	72"	60"	72"	60"	72"
Opening Height		30"	36"	30"	36"	30"	36"	30"	36"
Width	Depth	Cat. No.	Cat. No.	Cat. No.	Cat. No.	Cat. No.	Cat. No.	Cat. No.	Cat. No.
12"	12"	6211G	6231G	6211M	6231M	6C211	6C231	6E211	6E231
	15"	6213G	6233G	6213M	6233M	6C213	6C233	6E213	6E233
	18"	6215G	6235G	6215M	6235M	6C215	6C235	6E215	6E235
	21"	6217G	6218G	6217M	6218M	6C217	6C218	6E217	6E218
	24"	-	6220G	-	6220M	-	-	-	6E220
15"	12"	6227G	6239G	-	6239M	6C227	6C239	6E227	6E239
	15"	6229G	6241G	-	6241M	6C229	6C241	6E229	6E241
	18"	6237G	6243G	-	6243M	6C237	6C243	6E237	6E243
	21"	6257G	6245G	-	6245M	6C257	6C245	6E257	6E245
	24"	-	6246G	-	6246M	-	-	-	-
18"	18"	-	6247G	-	-	-	6C247	6E281	6E247
	21"	-	6249G	-	-	-	6C249	6E283	6E249

### Guardian 3 Tier Lockers

		Standard 16 ga.		Medallion 16 ga.	Guardian PLUS 14 ga.		Defiant II Latch 14 ga.	
Overall Height		60"	72"	72"	60"	72"	60"	72"
Opening Height		20"	24"	24"	20"	24"	20"	24"
Width	Depth	Cat. No.	Cat. No.	Cat. No.	Cat. No.	Cat. No.	Cat. No.	Cat. No.
12"	12"	6407G	6419G	6419M	6C407	6C419	6E407	6E419
	15"	6409G	6421G	6421M	6C409	6C421	6E409	6E421
	18"	6411G	6423G	6423M	6C411	6C423	6E411	6E423
	21"	6449G	6499G	6499M	6C449	6C499	6E449	6E499
15"	12"	-	6425G	-	-	6C425	-	6E425
	15"	6451G	6427G	-	-	6C427	6E451	6E427
	18"	6453G	6429G	-	-	6C429	6E453	6E429
	21"	6455G	6437G	-	-	6C437	6E455	6E437

### Guardian 2 Person Lockers

		Standard 16 ga.	Medallion 16 ga.
Overall Height		72"	72"
Opening Height		52"	52"
Width	Depth	Cat. No.	Cat. No.
15"	15"	6501G	6501M
	18"	6503G	6503M

### Guardian Duplex Lockers

		Standard 16 ga.
Opening Height		72"
Width	Depth	Cat. No.
15"	15"	6531G
	18"	6533G

\* Standard Guardian & Medallion Option doors less than 12" wide are 18 gauge.

NOTE: 1, 2 & 3 Tier, 2 Person and Duplex lockers are ordered by the FRAME. Overall heights do NOT include legs.

# Invincible II™

## Steel Lockers

### At a Glance

- Knock Down Construction
- Diamond perforations on door and sides
- 14 ga. door, 16 ga. body & 18 ga. back
- Classic III or Defiant II pocket available on 1, 2 and 3 tier
- Friction or spring latch on 4 through 9 tier

### Ventilation Options



Diamond Shaped (S)



Standard Louvers (O)



Full Louvers (O)



Mini Louvers (O)



Solid Door (O)

### Door Handle Options

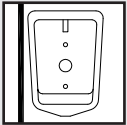

Classic III Recessed (S)

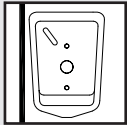

Defiant II Recessed (O)

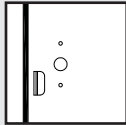

Friction Catch (SB)

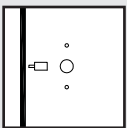

Slam Latch (OB)

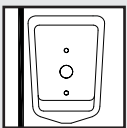

Defiant II Rotary Recessed (A)

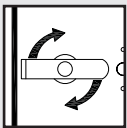

Cremone Turn Handle  
(A - On most 1, 2 and 3 Tier models)

A = Available\*

S = Standard

O = Optional\*

SB = Std. on Box Lockers\*

OB = Optional on Box Lockers\*

\*additional charges may apply

## Invincible II™

Specifications can be found in the Penco Lockers catalog or on [pencoproducts.com](http://pencoproducts.com).



Penco's Invincible II athletic lockers are an exceptionally attractive and durable choice for gym lockers. Ideal for applications that require a high degree of ventilation and strength, or where visual inspection of locker contents is desired.

Doors are made from heavy 14 gauge steel. Sides, tops, bottoms and shelves are 16 gauge steel. Backs are 18 gauge. Doors and sides are perforated with a diamond-shaped pattern allowing maximum air circulation while maintaining security. Solid doors are an option.

Invincible II lockers come in a variety of styles: 1 tier, 2 tier and 3 tier all have as standard the Classic III stainless steel recessed pocket and multi-point latching. Standard 4, 5, 6, 8 and 9 tier box lockers doors have a padlock hasp and a friction catch, and will accept built-in locks. Available at extra cost is a spring-loaded catch.

Both 2 & 3 tier lockers have horizontal frame members welded between the doors for added strength and security. 24" wide lockers have full width doors. If slope tops are required, use hoods. All lockers accept built-in locks or padlocks and have rubber bumpers on the latch hooks to reduce noise.



1 Tier

2 Tier

3 Tier

4 Tier

5 Tier

6 Tier

8 Tier

9 Tier

# Invincible II™

## Sizes and Dimensions

Invincible II 1 Tier Lockers					
		Std. Cat. No.		Defiant II	
Overall Ht.		-	-	-	-
Opening Ht.		60"	72"	60"	72"
Width	Depth	Cat. No.	Cat. No.	Cat. No.	Cat. No.
9"	12"	6A101	6A107	-	-
	15"	6A103	6A109	-	-
	18"	6A105	6A111	-	-
12"	12"	6A129	6A157	6P129	6P157
	15"	6A131	6A159	6P131	6P159
	18"	6A135	6A161	6P135	6P161
	21"	6A133	6A163	-	-
15"	15"	6A143	6A169	6P143	6P169
	18"	6A145	6A171	6P145	6P171
	21"	6A147	6A173	6P147	6P173
	24"	-	6A172	-	-
18"	15"	6A149	6A175	6P149	6P175
	18"	6A151	6A177	6P151	6P177
	21"	6A153	6A179	6P153	6P179
	24"	6A155	6A181	6P155	6P181
24"	15"	-	6A182	-	-
	18"	6A117	6A123	6P117	6P123
	21"	6A119	6A125	6P119	6P125
	24"	6A121	6A127	6P121	6P127

Invincible II 2 Tier Lockers					
		Std. Cat. No.		Defiant II	
Overall Ht.		60"	72"	60"	72"
Opening Ht.		30"	36"	30"	36"
Width	Depth	Cat. No.	Cat. No.	Cat. No.	Cat. No.
9"	12"	-	-	-	-
	15"	-	-	-	-
	18"	-	-	-	-
12"	12"	6A213	6A245	6P213	6P245
	15"	6A215	6A247	6P215	6P247
	18"	6A217	6A249	6P217	6P249
	21"	-	6A251	-	-
15"	15"	6A225	6A257	6P225	6P257
	18"	6A239	6A259	6P239	6P259
	21"	6A241	6A261	6P241	6P261
	24"	-	6A253	-	-
18"	15"	6A223	6A263	6P223	6P263
	18"	6A227	6A265	6P227	6P265
	21"	6A229	6A267	6P229	6P267
	24"	6A231	6A269	6P231	6P269
24"	15"	-	-	-	-
	18"	6A233	6A271	6P233	6P271
	21"	6A235	6A273	6P235	6P273
	24"	6A237	6A275	6P237	6P275

Invincible II 3 Tier Lockers					
		Std. Cat. No.		Defiant II	
Overall Ht.		60"	72"	60"	72"
Opening Ht.		20"	24"	20"	24"
Width	Depth	Cat. No.	Cat. No.	Cat. No.	Cat. No.
9"	12"	-	-	-	-
	15"	-	-	-	-
	18"	-	-	-	-
12"	12"	6A287	6A281	6P287	6P281
	15"	6A289	6A283	6P289	6P283
	18"	6A291	6A285	6P291	6P285
	21"	-	-	-	-
15"	15"	6A293	6A301	6P293	6P301
	18"	6A295	6A303	6P295	6P303
	21"	6A297	6A305	6P297	6P305
	24"	-	-	-	-
18"	15"	-	-	-	-
	18"	6A220	6A221	-	-
	21"	-	-	-	-
	24"	-	-	-	-
24"	15"	-	-	-	-
	18"	-	-	-	-
	21"	-	-	-	-
	24"	-	-	-	-

### Invincible II 4, 5, 6, 8 & 9 Tier Box Lockers

		4 Tier		5 Tier		6 Tier	8 Tier	9 Tier
Overall Height		60"	72"	60"	72"	72"	72"	72"
Opening Height		15"	18"	12"	14-2/5"	12"	9"	8"
Width	Depth	Cat. No.	Cat. No.	Cat. No.	Cat. No.	Cat. No.	Cat. No.	Cat. No.
12"	12"	6A307	6A319	6A351	6A363	6A375	6A393	6A407
	15"	6A309	6A321	6A353	6A365	6A377	6A395	6A409
	18"	6A311	6A323	6A355	6A367	6A379	6A397	6A411
	21"	-	-	-	-	6A381	-	-
15"	15"	6A313	6A331	6A357	6A369	6A383	6A401	6A413
	18"	6A315	6A335	6A359	6A371	6A385	6A403	6A415
	21"	-	-	6A361	6A373	6A389	6A405	6A417
18"	18"	-	-	6A419	6A445	6A423	-	-
	21"	-	-	6A421	6A447	6A425	-	-

### Group Ends for Invincible II Lockers

		Perforated Single Row		Solid Single Row	
Height	Depth	1 - 6 Tier Cat. No.	8 & 9 Tier Cat. No.	1 - 6 Tier Cat. No.	8 & 9 Tier Cat. No.
36-1/2"	12"	603600V	-	603601S	-
	15"	603602V	-	603603S	-
	18"	603704V	-	603605S	-
48-1/2"	12"	603606V	-	603607S	-
	15"	603608V	-	603609S	-
	18"	603700V	-	603701S	-
60"	12"	602100V	-	602101S	-
	15"	602102V	-	602103S	-
	18"	602104V	-	602105S	-
	21"	602106V	-	602107S	-
72"	12"	602108V	-	602109S	-
	12"	602110V	602120V	602111S	602121S
	15"	602112V	602122V	602113S	602123S
	18"	602114V	602124V	602115S	602125S
	21"	602116V	602126V	602117S	602127S
24"	602118V	-	602119S	-	

### Ordering Group Ends for Invincible II Lockers

You must order a Group End to finish each group of Invincible II lockers, regardless of length of each group or row. Specify Perforated or Solid.

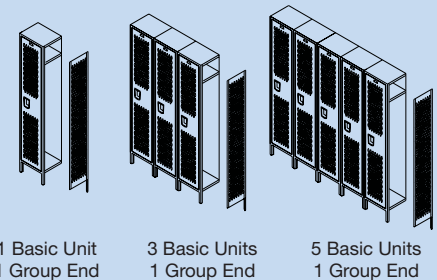

# All-Welded Steel Lockers

## At a Glance

- 16 ga. body & 18 ga. back for durability
- 14 ga. door and Classic III handle standard
- Optional Defiant II single point latching
- Ships fully assembled

## Ventilation Options



Diamond Shaped (S)



Standard Louvers (O)



Full Louvers (O)



Mini Louvers (O)



Solid Door (O)

## Base Options



No Legs or Base (S)



4" Legs (O)



Channel Base (O)

## Door Handle Options

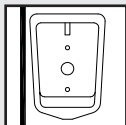

Classic III Recessed (S)

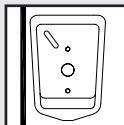

Defiant II Recessed (O)

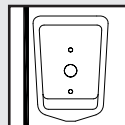

Defiant II Rotary Recessed (O)

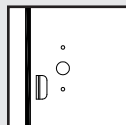

Friction Catch (SB)

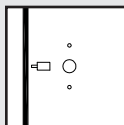

Slam Latch (OB)

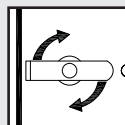

Cremone Turn Handle (A-On most 1, 2 and 3 Tier models)

A = Available  
S = Standard  
O = Optional\*

SB = Standard on Box Lockers  
OB = Optional on Box Lockers  
\*additional charges may apply

## All-Welded

Specifications can be found in the Penco Lockers catalog or on [pencoproducts.com](http://pencoproducts.com).

## The All-Welded Alternative

Penco's All-Welded Lockers give you a choice between our traditional K.D. locker lines, and our All-Welded setup lockers.

All-Welded lockers offer superior resistance to hard use and abuse. All body parts are welded into a single rigid unit to resist damage for the life of the product. The door frame and locker side are 16 gauge. The backs, tops and bottoms of each group of lockers are made from single pieces of steel that span multiple lockers. The doors are made from 14 gauge steel and include a continuous hinge. Sides, tops, bottoms and shelves are 16 gauge steel. Backs are 18 gauge.

Since All-Welded lockers are shipped pre-assembled, the time and expense of on-site installation is greatly

reduced. This is a great help where labor is either extremely expensive, or hard to find. Groupings will be determined by Penco based upon the floor plan layout drawings submitted with the order (not to exceed 54").

All-Welded lockers are available as standard in ventilated models with diamond-shaped perforations in the doors and sides for maximum visibility and ventilation, or with solid door and side construction, with or without door louvers. The perforated models are ideal for heavy duty athletic use, where ventilation is important to aid the drying of athletic gear.

Standard construction is flat top without legs. Lockers can be ordered with 4" high legs or 4" high 16 gauge integral Channel Bases, as options.





# All-Welded Sizes and Dimensions

## All-Welded 1 Tier Lockers

		Standard Cat. No.		Defiant II Latch	
Opening Height		60"	72"	60"	72"
Unit Width	Unit Depth	Cat. No.	Cat. No.	Cat. No.	Cat. No.
9"	12"	6WP100	6WP120	-	-
	15"	6WP101	6WP121	-	-
	18"	6WP102	6WP122	-	-
12"	12"	6WP103	6WP123	6WD103	6WD123
	15"	6WP104	6WP124	6WD104	6WD124
	18"	6WP105	6WP125	6WD105	6WD125
	21"	6WP106	6WP126	-	-
	24"	6WP107	6WP127	-	-
15"	12"	6WP108	6WP128	-	6WD128
	15"	6WP109	6WP129	6WD109	6WD129
	18"	6WP110	6WP130	6WD110	6WD130
	21"	6WP111	6WP131	6WD111	6WD131
	24"	6WP112	6WP132	-	-
18"	12"	6WP172	6WP182	6WD172	-
	15"	6WP173	6WP183	6WD173	-
	18"	6WP113	6WP133	6WD113	6WD133
	21"	6WP114	6WP134	6WD114	6WD134
	24"	6WP115	6WP135	6WD115	6WD135
24"	18"	6WP116	6WP136	6WD116	6WD136
	21"	6WP117	6WP137	6WD117	6WD137
	24"	6WP118	6WP138	6WD118	6WD138

## All-Welded 2 Tier Lockers

		Standard Cat. No.		Defiant II Latch	
Overall Height		60"	72"	60"	72"
Opening Height		30"	36"	30"	36"
Unit Width	Unit Depth	Cat. No.	Cat. No.	Cat. No.	Cat. No.
12"	12"	6WP203	6WP223	6WD203	6WD223
	15"	6WP204	6WP224	6WD204	6WD224
	18"	6WP205	6WP225	6WD205	6WD225
	21"	6WP206	6WP226	-	-
15"	24"	6WP207	6WP227	-	-
	12"	6WP208	6WP228	6WD208	6WD228
	15"	6WP209	6WP229	6WD209	6WD229
	18"	6WP210	6WP230	6WD210	6WD230
18"	21"	6WP211	6WP231	6WD211	6WD231
	24"	6WP212	6WP232	-	6WD232
	12"	-	6WP282	-	-
	15"	6WP273	6WP283	-	-
24"	18"	6WP213	6WP233	6WD213	6WD233
	21"	6WP214	6WP234	6WD214	6WD234
	24"	6WP215	6WP235	6WD215	6WD235
	18"	6WP216	6WP236	-	-
24"	21"	6WP217	6WP237	-	-
	24"	6WP218	6WP238	-	-

## All-Welded 3 Tier Lockers

		Std. Cat. No.		Defiant II Latch	
Overall Height		60"	72"	60"	72"
Opening Height		20"	24"	20"	24"
Unit Width	Unit Depth	Cat. No.	Cat. No.	Cat. No.	Cat. No.
12"	12"	6WP303	6WP323	6WD303	6WD323
	15"	6WP304	6WP324	6WD304	6WD324
	18"	6WP305	6WP325	6WD305	6WD325
	21"	6W9306	6WP326	-	-
	24"	6WP307	6WP327	-	-
15"	12"	6WP308	6WP328	-	-
	15"	6WP309	6WP329	6WD309	6WD329
	18"	6WP310	6WP330	6WD310	6WD330
	21"	6WP311	6WP331	6WD311	6WD331
18"	24"	6WP312	6WP332	-	-
	12"	-	-	-	-
	15"	-	-	-	-
	18"	6WP313	6WP333	-	6WD333
	21"	6WP314	6WP334	-	6WD334
24"	6WP315	6WP335	-	6WD335	

## All-Welded 4, 5, 6, 8 & 9 Tier Box Lockers

		4 Tier		5 Tier		6 Tier	8 Tier	9 Tier
Overall Ht.		60"	72"	60"	72"	72"	72"	72"
Opening Ht.		15"	18"	12"	14-2/5"	12"	9"	8"
Unit Width	Unit Depth	Cat. No.	Cat. No.	Cat. No.	Cat. No.	Cat. No.	Cat. No.	Cat. No.
12"	12"	6WP403	6WP423	6WP503	6WP523	6WP623	6WP823	6WP923
	15"	6WP404	6WP424	6WP504	6WP524	6WP624	6WP824	6WP924
	18"	6WP405	6WP425	6WP505	6WP525	6WP625	6WP825	6WP925
	21"	6WP406	6WP426	6WP506	6WP526	6WP626	-	-
	24"	6WP407	6WP427	6WP507	6WP527	6WP627	-	-
15"	12"	6WP408	6WP428	6WP508	6WP528	6WP628	6WP828	6WP928
	15"	6WP409	6WP429	6WP509	6WP529	6WP629	6WP829	6WP929
	18"	6WP410	6WP430	6WP510	6WP530	6WP630	6WP830	6WP930
	21"	6WP411	6WP431	6WP511	6WP531	6WP631	-	-
18"	24"	6WP412	6WP432	6WP512	6WP532	6WP632	-	-
	18"	-	-	6WP513	-	6WP633	-	-
	21"	-	-	6WP514	-	6WP634	-	-

# Angle Iron Steel Lockers

## At a Glance

- Fully welded angle frame construction
- Continuous piano-style hinges standard (or optional 3" butt hinges)
- Diamond, solid or expanded metal sides
- Bottom reinforced with a 16 gauge channel

## Ventilation Options



Diamond Shaped (S)



Standard Louvers (O)



Full Louvers (O)



Mini Louvers (O)



Solid Door (O)

## Base Options



No Legs or Base (S)



Channel Base (O)

## Door Handle Options

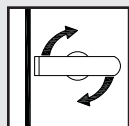

Cremone 3 Point (O)

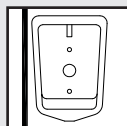

Classic III Recessed (O)

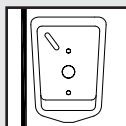

Defiant II Recessed (O)

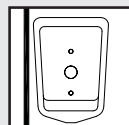

Defiant II Rotary Recessed (O)

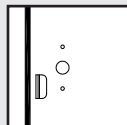

Friction Catch (SB)

S = Standard  
O = Optional\*

SB = Standard on Box Lockers

\*additional charges may apply

# Angle Iron

Specifications can be found in the Penco Lockers catalog or on [pencoproducts.com](http://pencoproducts.com).

## Rugged Welded Angle Iron Framework

The Penco Angle Iron Locker is built within a 1" x 1" x 1/8" angle iron frame. This 1/8" thick angle iron exoskeleton creates extra strong locker edges and provides a solid framework. Diamond perforated doors and sides offer a high degree of air flow.

Lockers are built in groups with the top, bottom and back panels spanning multiple lockers, which reduces seams and adds rigidity.

### Options and Accessories:

- Multiple handle/latch types
- Continuous Slope Hoods
- Padlocks and built-in locks
- Optional 4" high 14 gauge welded base
- Optional Expanded Metal Sides

### Angle Iron Advantages:

- Excellent for Athletic Applications
- Rugged Welded Angle Iron Framework
- Durable Continuous Hinges or Optional 3" butt Hinges
- Two Multi-Point Latch Options on 1 & 2 Tier



# Angle Iron

## Sizes and Dimensions

Angle Iron 1 Tier					
		Defiant II Latch		Cremone Turn Handle	
Opening Height		60"	72"	60"	72"
Width	Depth				
12"	12"	6WA103	6WA123	6WAT103	6WAT123
	15"	6WA104	6WA124	6WAT104	6WAT124
	18"	6WA105	6WA125	6WAT105	6WAT125
15"	12"	-	6WA128	-	6WAT128
	15"	6WA109	6WA129	6WAT109	6WAT129
	18"	6WA110	6WA130	6WAT110	6WAT130
18"	15"	6WA173	6WA183	6WAT173	6WAT183
	18"	6WA113	6WA133	6WAT113	6WAT133
	21"	6WA114	6WA134	6WAT114	6WAT134
	24"	6WA115	6WA135	6WAT115	6WAT135
24"	18"	6WA116	6WA136	6WAT116	6WAT136
	21"	6WA117	6WA137	6WAT117	6WAT137
	24"	6WA118	6WA138	6WAT118	6WAT138

Angle Iron 2 Tier					
		Defiant II Latch		Cremone Turn Handle	
Overall Height		60"	72"	60"	72"
Opening Height		30"	36"	30"	36"
Width	Depth	Cat. No.	Cat. No.	Cat. No.	Cat. No.
12"	12"	6WA203	6WA223	6WAT203	6WAT223
	15"	6WA204	6WA224	6WAT204	6WAT224
	18"	6WA205	6WA225	6WAT205	6WAT225
15"	12"	6WA208	6WA228	6WAT208	6WAT228
	15"	6WA209	6WA229	6WAT209	6WAT229
	18"	6WA210	6WA230	6WAT210	6WAT230
18"	15"	6WA273	6WA283	6WAT273	6WAT283
	18"	6WA213	6WA233	6WAT213	6WAT233
	21"	6WA214	6WA234	6WAT214	6WAT234

Angle Iron 3 Tier					
		Defiant II Latch		Cremone Turn Handle	
Overall Height		60"	72"	60"	72"
Opening Height		20"	24"	20"	24"
Width	Depth	Cat. No.	Cat. No.	Cat. No.	Cat. No.
12"	12"	6WA303	6WA323	6WAT303	6WAT323
	15"	6WA304	6WA324	6WAT304	6WAT324
	18"	6WA305	6WA325	6WAT305	6WAT325
15"	12"	6WA308	6WA328	6WAT308	6WAT328
	15"	6WA309	6WA329	6WAT309	6WAT329
	18"	6WA310	6WA330	6WAT310	6WAT330
18"	18"	6WA313	6WA333	6WAT313	6WAT333
	21"	6WA314	6WA334	6WAT314	6WAT334
	24"	6WA315	6WA335	6WAT315	6WAT335



The Angle Iron locker frame is highlighted in blue in this photo.

Angle Iron 6 Tier Box Locker		
		Friction Catch
Overall Height		72"
Opening Height		12"
Width	Depth	Cat. No.
12"	12"	6WA623
	15"	6WA624
	18"	6WA625
	21"	6WA626
	24"	6WA627
15"	12"	6WA628
	15"	6WA629
	18"	6WA630
	21"	6WA631
	24"	6WA632

# Stadium®

## Team Room Lockers

### At a Glance

- Knocked down or welded construction
- Open fronts and smooth frame channels
- 2 lockable compartment options
- 18", 24" and 33" wide models
- Tops, bottoms, sides, shelf and frames are 16 gauge
- Back is 18 gauge

### Ventilation



Mini Louvers

Diamond perforated sides. Lockers equipped with a footlocker have Mini Louvers punched in the front panel.

### Door Handle Options

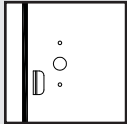

Friction Catch (O)

On models equipped with a Security Box

### Accessories



Locking Security Box (O)

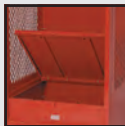

Footlocker (O)

O = Optional\*  
\*additional charges may apply

# Stadium®

Specifications can be found in the Penco Lockers catalog or on [pencoproducts.com](http://pencoproducts.com).

### The Right Locker for Athletes and Their Equipment

Penco's Stadium lockers are ideally suited for athletic team rooms, fire fighter's equipment or any other application where easy access to uniforms and/or equipment is required.

They are available in different configurations: the minimum configuration has a full width shelf, 2 coat hooks and a coat rod. You can add a lockable security box, a lockable foot locker that doubles as a bench, or both. The open front and diamond perforated sides create full ventilation while allocating a specific storage space to each individual.

Fully accessorized, Stadium lockers are outfitted with a security box fastened to a full width shelf, and a footlocker with a hinged, reinforced seat at the base. Both compartments are lockable to secure valuable items. The front of the footlocker is recessed for an external padlock, and a stainless steel strike plate protects the finish. The footlocker design saves floor space by eliminating the clutter of open locker doors and the need for separate locker room benches.

Stadium lockers are available in Welded construction or K.D.

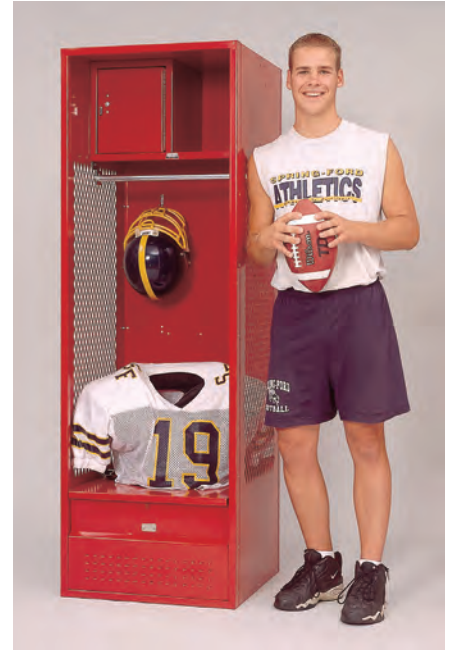

(knocked down or unassembled). They are available in 18", 24" or 33" widths and 18", 21" or 24" depths. K.D. lockers are 72" high; All-Welded models have an integral 4" base, bringing the total height to 76".

Color selection is from any one of Penco's 24 designer colors.



# Stadium®

## Sizes and Dimensions

### K.D. Stadium Lockers with Perforated Sides

Width	Depth	Height	With Shelf	With Shelf & Security Box	With Shelf & Footlocker	With Shelf, Footlocker & Security Box
18"	18"	72"	6KFD01	6KFD09	6KFD02	6KFD03
24"	18"	72"	6KFD10	6KFD11	6KFD12	6KFD13
	21"	72"	6KFD20	6KFD21	6KFD22	6KFD23
	24"	72"	6KFD30	6KFD31	6KFD32	6KFD33
33"	18"	72"	6KFD40	6KFD41	6KFD42	6KFD43
	21"	72"	6KFD50	6KFD51	6KFD52	6KFD53
	24"	72"	6KFD60	6KFD61	6KFD62	6KFD63

### Welded Stadium Lockers with Perforated Sides

Width	Depth	Height	With Shelf	With Shelf & Security Box	With Shelf & Footlocker	With Shelf, Footlocker & Security Box
18"	18"	76"	6WFD01	6WFD09	6WFD02	6WFD03
24"	18"	76"	6WFD10	6WFD11	6WFD12	6WFD13
	21"	76"	6WFD20	6WFD21	6WFD22	6WFD23
	24"	76"	6WFD30	6WFD31	6WFD32	6WFD33
33"	18"	76"	6WFD40	6WFD41	6WFD42	6WFD43
	21"	76"	6WFD50	6WFD51	6WFD52	6WFD53
	24"	76"	6WFD60	6WFD61	6WFD62	6WFD63



All-Welded  
With 4" Base



KD  
w/ Shelf



KD w/ Shelf  
& Security Box



KD w/ Shelf  
& Footlocker



KD w/ Shelf,  
Security Box & Footlocker

# Patriot®

## First Responder Lockers

Penco Patriot® lockers are designed exclusively for first responders of all types: police, fire, military, EMS, etc. They are available in three basic versions: *Gear*, *Turnout* and *Duty*, all of which can be accessorized to suite your specific needs. See below and the following pages for detailed information, sizes and accessories.



**Patriot specifications can be found in the Penco Lockers catalog or on [pencoproducts.com](http://pencoproducts.com).**

### Patriot Gear Lockers

**See Page 71**

When storing bulky protective or tactical gear, the size of the locker you select quickly becomes a factor. Gear models range from a big 24 inches wide to a massive 48 inches. All come standard with full height 14 gauge doors, beefy coat hooks and a 1" diameter coat rod.

- Construction – Welded or KD
- Height Available – 72". Welded Models Are 76" With Integral Base
- Widths Available – 24, 30, 36, 42 or 48"
- Ventilation – Louvered Doors. Diamond Perforated Sides.
- Lockable Compartments – Main doors, optional security box, drawer or footlocker
- Hanging – Heavy Duty Coat Rod and Hanging Hooks
- Latching – Cremone Handle



### Patriot Turnout Lockers

**See Page 72**

Seconds count when it's your job to be the first to respond. The Patriot Turnout locker shares the same heavy gauge steel construction as the Gear and Duty lockers, but its open front and smooth frame mean you can retrieve your equipment in a flash.

- Construction – Welded or KD
- Heights Available – 72" Welded Models Are 76" With Integral Base.
- Widths Available – 24, 30, 36, 42 or 48"
- Ventilation – Open Front. Diamond Perforated Sides.
- Lockable Compartments – Optional security box, drawer or footlocker
- Hanging – Heavy Duty Coat Rod and Hanging Hooks
- Latching – Open Front



### Patriot Duty Lockers

**See Page 74**

Duty lockers answer the call with law enforcement and security professionals in mind. A fully equipped interior featuring preconfigured compartments and additional private storage means what you need is where you need it when you need it.

- Construction – Welded or KD
- Heights Available – 60 or 72"
- Widths Available – 18 or 24"
- Ventilation – Perforated Top, Hat Shelf. Louvered Doors and Drawer
- Lockable Compartments – Main doors, drawer and interior side compartment
- Hanging – Heavy Duty Coat Rod and Hanging Hooks
- Latching – Cremone Handle
- Electrical Access – Single Gang Duplex Knockout In Top Panel



# Patriot® Gear Lockers

## Patriot Gear Lockers

A properly equipped double door Patriot Gear locker can be the ideal solution for a variety of specialized storage challenges. The ample storage areas at both top and bottom of the 24" wide model shown on this page still leave almost 4 feet between the shelves for hanging uniforms and other gear.

### Distinguishing Features:

- All sizes are offered in welded or knocked down construction
- Integral channel base is standard on welded models
- Factory assembly available on KD models
- Double doors require less clear area in front of the locker to open
- 24 inch deep locker available in 24, 30, 36, 42 or 48 inch widths
- 18 inch deep locker available up to 36 inches wide
- Optional centered divider allows shelves and coat rods to be placed on either side during assembly
- Cremone handle standard on all Gear Lockers

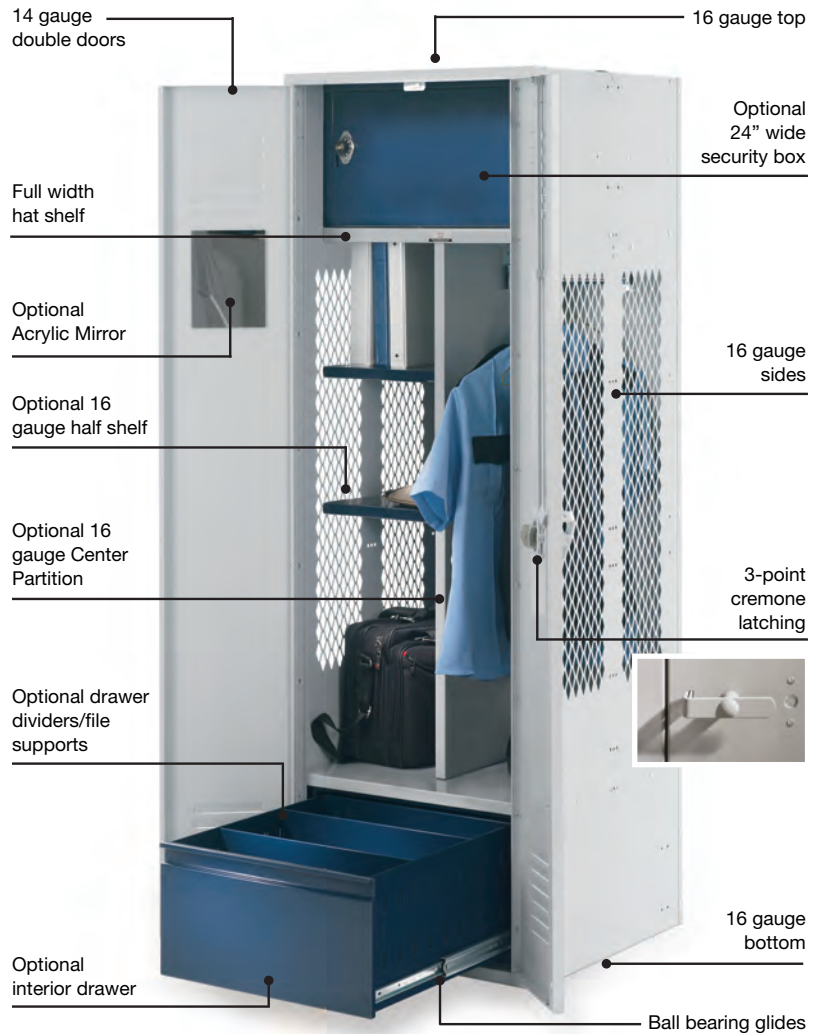

### Patriot® Gear Lockers – 18" and 24" Deep

W x D		KD (Knocked Down) Construction		All-Welded Construction	
W	D	H	Cat. No.	H	Cat. No.
With 15" Deep Shelf					
18 (SD)	18	72	6KGDA84	76	6WGDA84C
24 (SD)	18	72	6KGDA94	76	6WGDA94C
24	18	72	6KGDA04	76	6WGDA04C
30	18	72	6KGDA14	76	6WGDA14C
36	18	72	6KGDA24	76	6WGDA24C
24	24	72	6KGDA00	76	6WGDA00C
30	24	72	6KGDA10	76	6WGDA10C
36	24	72	6KGDA20	76	6WGDA20C
42	24	72	6KGDA30	76	6WGDA30C
48	24	72	6KGDA40	76	6WGDA40C
With 21" Deep Shelf					
18 (SD)	24	72	6KGDA82	76	6WGDA82C
24 (SD)	24	72	6KGDA92	76	6WGDA92C
24	24	72	6KGDA02	76	6WGDA02C
30	24	72	6KGDA12	76	6WGDA12C
36	24	72	6KGDA22	76	6WGDA22C
42	24	72	6KGDA32	76	6WGDA32C
48	24	72	6KGDA42	76	6WGDA42C

NOTE: "(SD)" denotes Single Door. All others have Double Doors.



# Patriot® Turnout Lockers

## Patriot Turnout Locker

The key to any turnout locker is the ability to grab and go. The Patriot Turnout locker puts everything from flight gear to EMS equipment within reach. The open front and perforated sides aid in drying gear while available security boxes, drawers and footlockers provide a secure space for personal items.

### Distinguishing Features:

- All sizes are offered in welded or knocked down construction
- Integral channel base is standard on welded models.
- Factory assembly available on KD models
- Open front and hemmed frame.
- 24 inch deep locker available in 24, 30, 36, 42 or 48 inch widths
- 18 inch deep locker available up to 36 inches wide.
- Number plates mount to the shelf face for easy visibility
- Sides are pre-punched on 12 inch vertical centers to accept additional shelves.

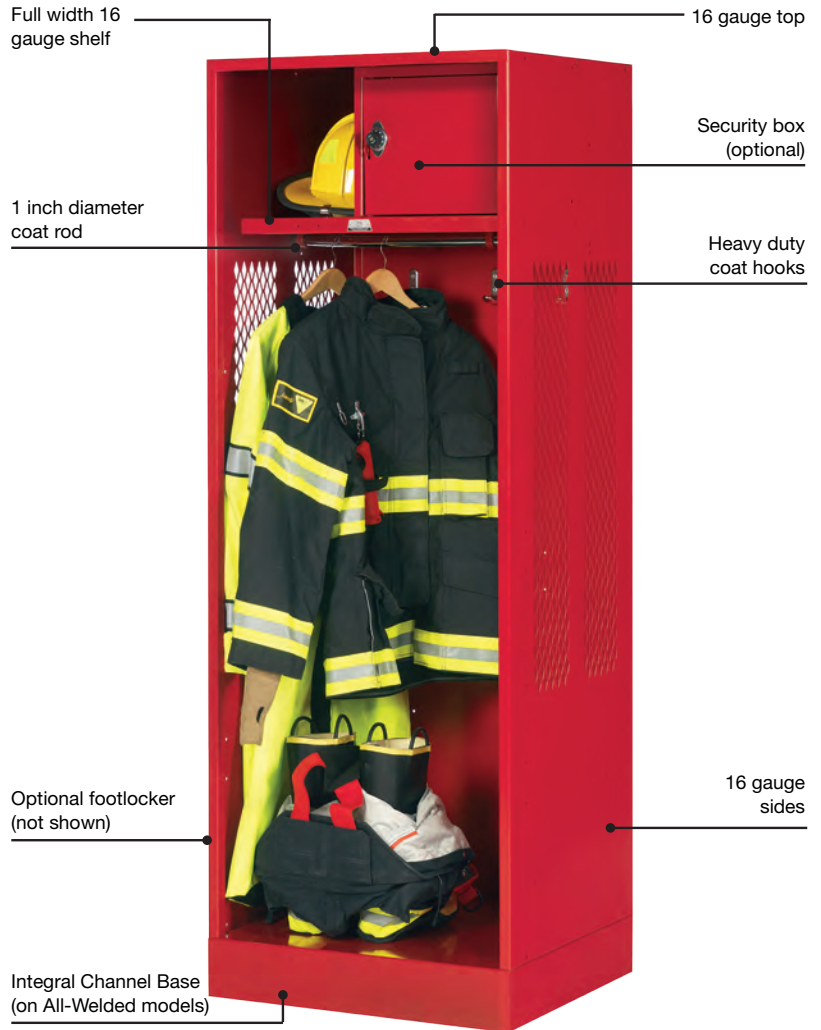

### Patriot® Turnout Lockers – 18” and 24” Deep

W x D		KD (Knocked Down) Construction		All-Welded Construction	
With 15” Deep Shelf					
W	D	H	Cat. No.	H	Cat. No.
18	18	72	6KTDA84	76	6WTDA84C
24	18	72	6KTDA04	76	6WTDA04C
30	18	72	6KTDA14	76	6WTDA14C
36	18	72	6KTDA24	76	6WTDA24C
24	24	72	6KTDA00	76	6WTDA00C
30	24	72	6KTDA10	76	6WTDA10C
36	24	72	6KTDA20	76	6WTDA20C
42	24	72	6KTDA30	76	6WTDA30C
48	24	72	6KTDA40	76	6WTDA40C
With 21” Deep Shelf					
18	24	72	6KTDA82	76	6WTDA82C
24	24	72	6KTDA02	76	6WTDA02C
30	24	72	6KTDA12	76	6WTDA12C
36	24	72	6KTDA22	76	6WTDA22C
42	24	72	6KTDA32	76	6WTDA32C
48	24	72	6KTDA42	76	6WTDA42C





## Gear and Turnout Locker Variations

One of the key strengths of the Patriot is its flexibility and modular accessories. Each Patriot accessory is designed for use in any of the four Patriot locker bodies.

### **PATRIOT®**

### Configure and Build to Suit

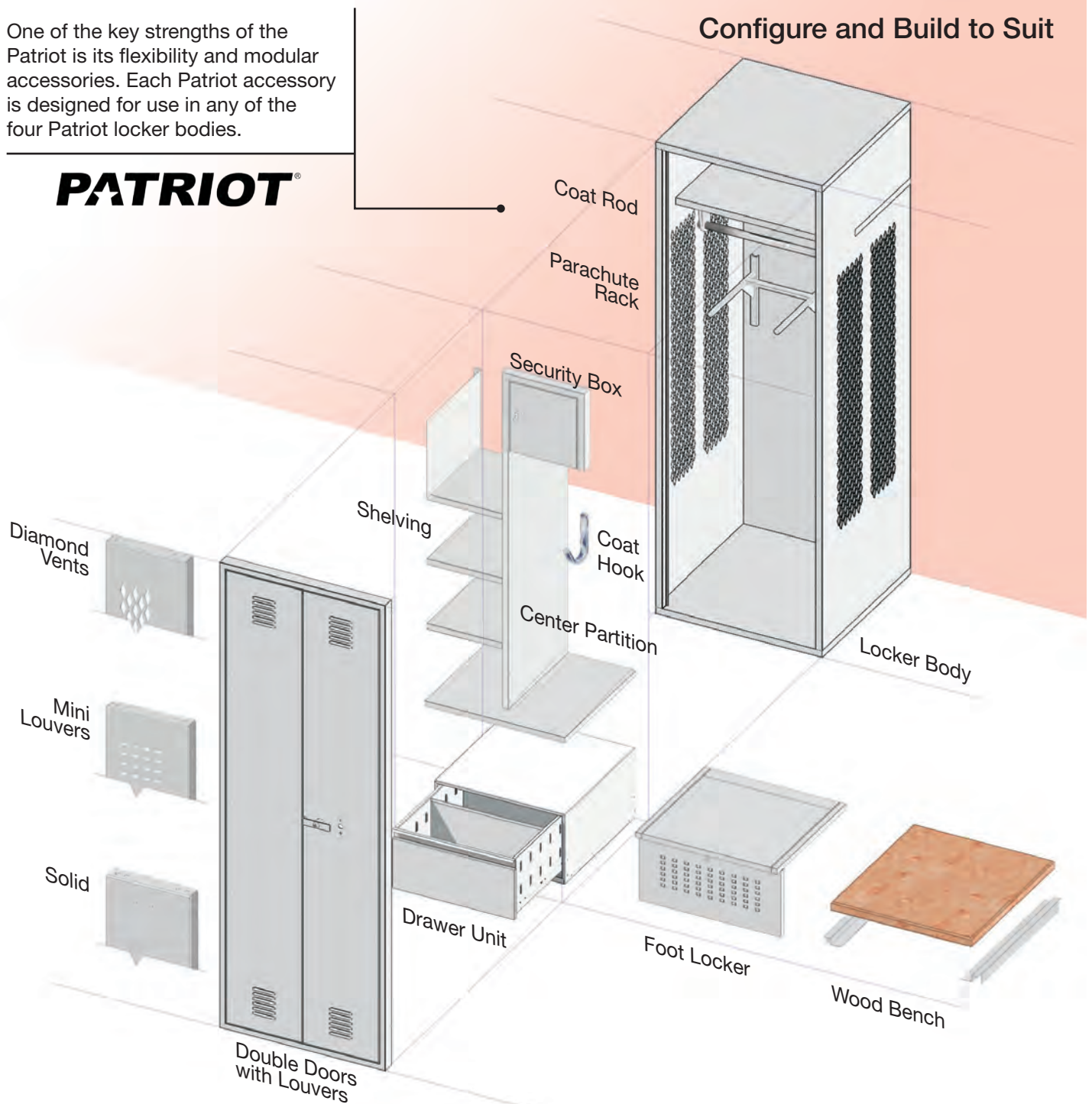

Cell Phone/Key Tray



Heavy Duty 1" Coat Rod with Brackets

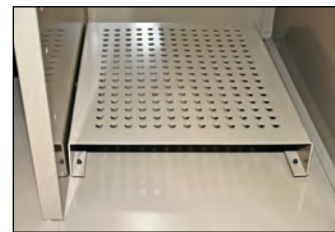

Boot Tray

# Patriot® Duty Lockers

## Patriot Duty Lockers

Built for law enforcement applications, the big story behind the Duty locker is actually under it. A 14 gauge welded shell, 16 gauge drawer and ball bearing glides provide at no less than 3.4 cubic feet of usable storage in the Patriot Duty Locker's drawer base. The 33" deep base also accepts individual or continuous lengths of hardwood locker benches for seating.

### Distinguishing Features:

- All sizes offered in welded or KD construction
- Factory assembly available on KD models
- 16 gauge Interior Divider and Side Shelf
- Ventilation slots on Locker Top
- Hat Shelf Ventilated on Garment Side
- Heavy Duty Coat Rod and Hooks on Garment Side
- Lockable Security Compartment
- Duplex knockout on locker top
- 24 inch deep Locker with 21 inch deep accessories
- 60 inch and 72 inch heights available
- Available with or without the drawer base

### Duty Locker Quick Facts

18" W Duty lockers have single doors; 24" W have double doors.  
Drawer bases are welded and bolted to the lockers.  
All Part numbers represent 1-wide units.  
Cremone handles are standard on all models.

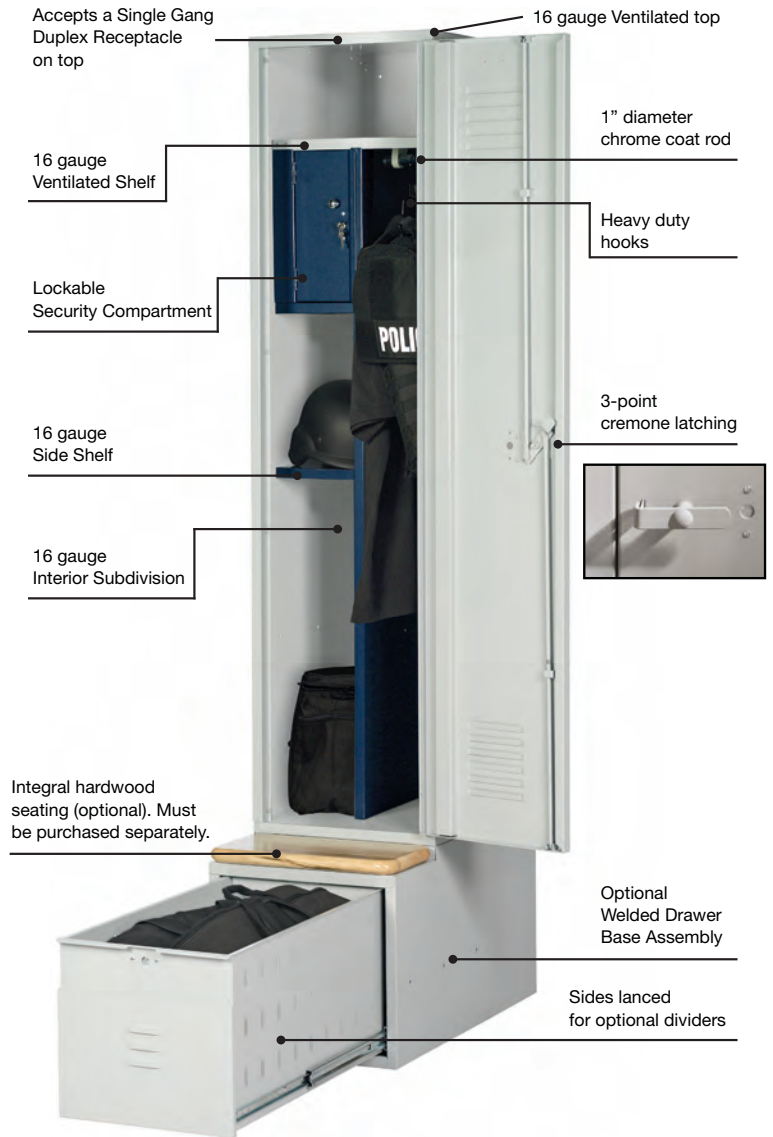

Patriot® Duty Lockers				
Size			KD (Knocked Down) Construction	All-Welded Construction
With 18" High Drawer Base				
W	D	H	Cat. No.	Cat. No.
18	24	60/78	64KD182478	64WD182478C
24	24	60/78	64KD242478	64WD242478C
18	24	72/90	64KD182490	64WD182490C
24	24	72/90	64KD242490	64WD242490C
With NO Base and NO Legs				
W	D	H	Cat. No.	Cat. No.
18	24	60	64KN182460	64WN182460C
24	24	60	64KN242460	64WN242460C
18	24	72	64KN182472	64WN182472C
24	24	72	64KN242472	64WN242472C
With 4" High Integral Channel Base				
W	D	H	Cat. No.	Cat. No.
18	24	64	-	64WCB182464C
24	24	64	-	64WCB242464C
18	24	76	-	64WCB182476C
24	24	76	-	64WCB242476C



# Patriot® Duty Locker Variations

Duty Lockers have pre-configured interiors for storing and organizing a wide range of equipment. The optional drawer base not only supports an integral seating surface but provides several additional cubic feet of storage. (Wood bench must be purchased separately.)

**PATRIOT®**

Configure and Build to Suit

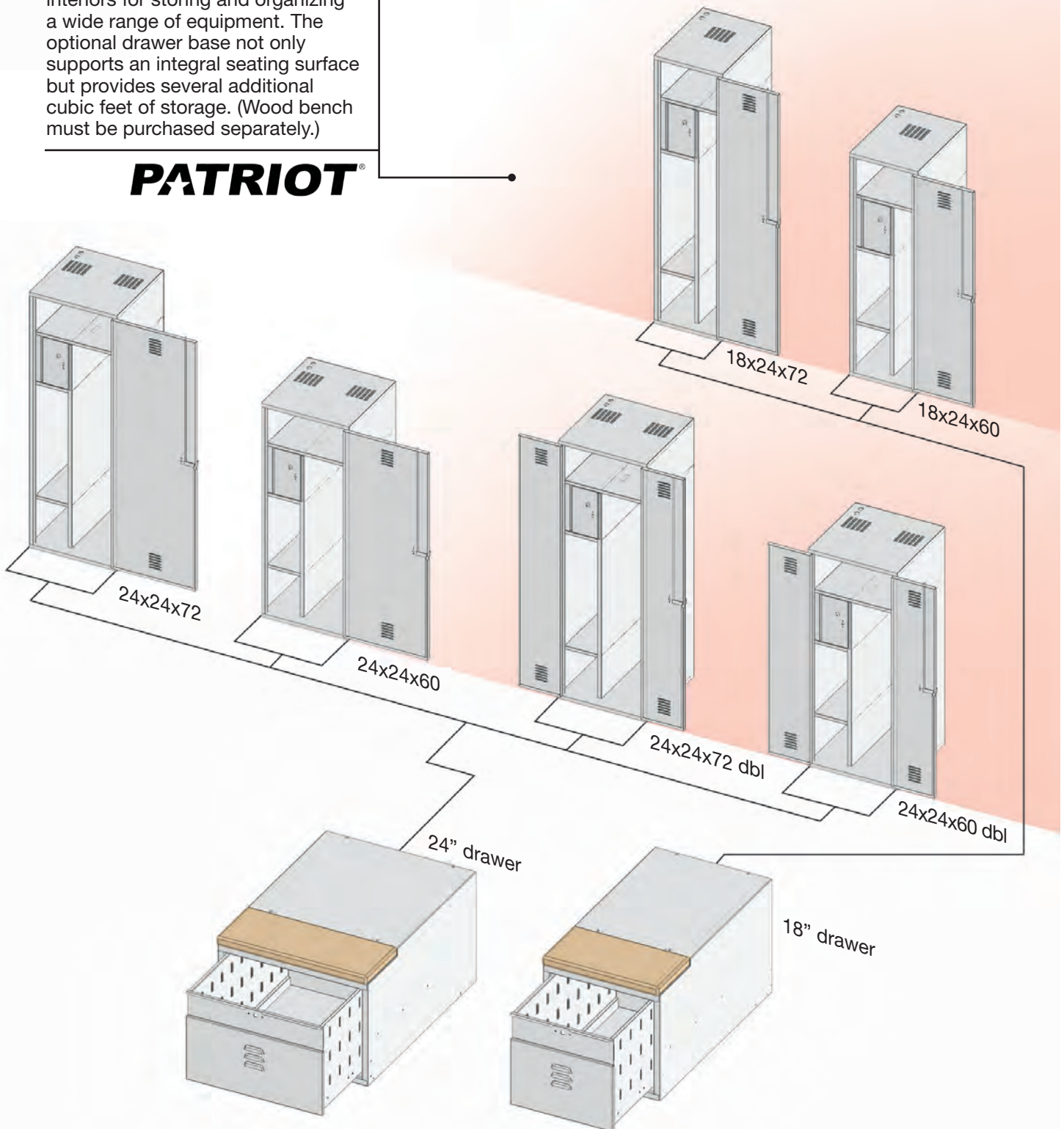

# Patriot®

## Duty Locker Details & Accessories

### Duty Locker Details

There is more to the Duty locker than hand-picked features and a range of popular sizes.

Aside from continuous hinges, turn handles and heavy gauge bodies, they stand apart from their Gear and Turnout counterparts with features standard only on Duty models.

We've perforated the hat shelf over the garment side of the locker so you get air flow where it's needed without sacrificing storage.

The tops of all Duty lockers are punched with special 1/8 x 1 inch slots to provide ventilation without compromising security.

If you need power for charging radios, phones and laptops, your local electrician can remove the factory knockouts, mount receptacles and tie them into your building's electrical service.

The use of standard locker benches to span multiple drawer bases is recommended to provide smooth and continuous seating. Your installer can field cut as necessary, or we can provide custom lengths with field joints, mitered corners, and right or left hand ends based upon your layout drawing.

# PATRIOT®

Specifications can be found in the Penco Lockers catalog or on [pencoproducts.com](http://pencoproducts.com).

### Accessories for Patriot DUTY Lockers Only

Description	W	D	H	Cat. No.
Extra Side Shelves (Duty Only)	10	21	-	6SHX297C
Drawer Dividers (Duty Only)	18	-	18	64DD1818C
	24	-	18	64DD2418C
Individual Hardwood Seat (Duty Only)	18	9-1/2	1-1/4	6RQ1242
	24	9-1/2	1-1/4	6RQ0575
Bulk Length Hardwood Bench	-	9-1/2	1-1/4	Varies

For more Patriot accessories, see the next page.



Duty Locker top with single gang duplex electrical knockout and ventilation slots



1" diameter coat rod and brackets fastened beneath ventilated shelf on garment side



Duty Locker with drawer base and optional continuous hardwood bench and extra half shelves

### -- Duty Locker Elevations --

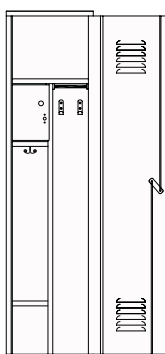

18" Wide/No Base  
Welded or KD

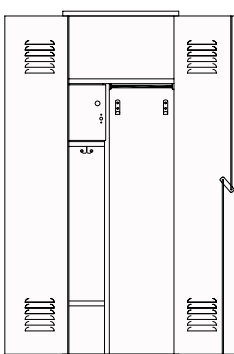

24" Wide/No Base  
Welded or KD

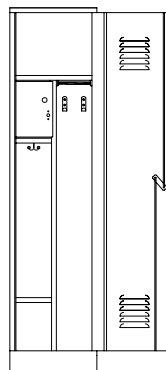

18" Wide/4" Base  
Welded

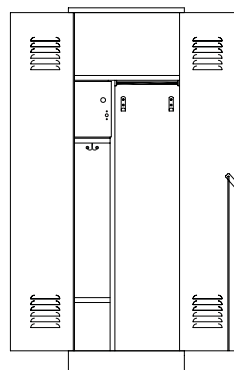

24" Wide/4" Base  
Welded

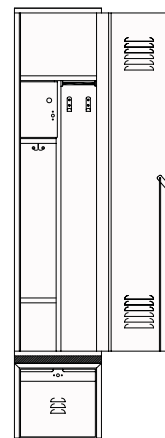

18" Wide/Drawer Base  
Welded or KD

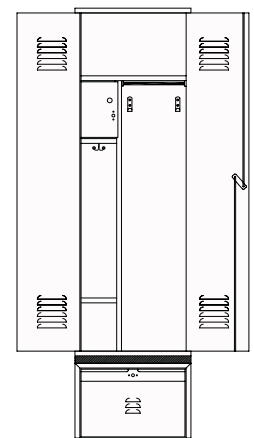

24" Wide/Drawer Base  
Welded or KD

# Patriot® Locker Accessories

Letter Codes below indicate where used: D=Duty, G=Gear, T=Turnout

Description		W	D	H	Cat. No.
<b>Center Partitions (G, T)</b>	Hat Shelf to Locker Bottom	-	15	58	6CPX269C
	Hat Shelf to Optional Bottom Shelf At 12 In.	-	15	45	6CPX270C
	Hat Shelf to Locker Bottom	-	21	58	6CPX300C
	Hat Shelf to Optional Bottom Shelf At 12 In.	-	21	45	6CPX301C
<b>Full Width Bottom Shelf (G, T)</b> (Required with Drawers)	18	18	-	6SHX695C	
	24	18	-	6SHX575C	
	30	18	-	6SHX576C	
	36	18	-	6SHX577C	
	18	24	-	6SHX696C	
	24	24	-	6SHX530C	
	30	24	-	6SHX531C	
	36	24	-	6SHX532C	
<b>Full Width Intermediate Shelf (G, T)</b> (Punched for Center Partition. Face is NOT punched for number plate.)	42	24	-	6SHX533C	
	48	24	-	6SHX534C	
	18	15	-	6SHX700C	
	24	15	-	6SHX708C	
	30	15	-	6SHX709C	
	36	15	-	6SHX710C	
	42	15	-	6SHX803C	
	48	15	-	6SHX804C	
	18	21	-	6SHX699C	
	24	21	-	6SHX703C	
<b>Half Shelves for use with Center Divider (G, T)</b> (Match Half Shelf and Divider to Hat Shelf depth)	30	21	-	6SHX704C	
	36	21	-	6SHX705C	
	42	21	-	6SHX706C	
	48	21	-	6SHX707C	
	9	15	-	6SHX697C	
	12	15	-	6SHX521C	
	15	15	-	6SHX522C	
	18	15	-	6SHX523C	
	21	15	-	6SHX524C	
	24	15	-	6SHX525C	
<b>Footlocker (G, T)</b> (Not for use with Center Dividers)	9	21	-	6SHX698C	
	12	21	-	6SHX561C	
	15	21	-	6SHX562C	
	18	21	-	6SHX563C	
	21	21	-	6SHX564C	
	24	21	-	6SHX565C	
	18	18	12	6ACXHK58H	
	24	18	12	6ACXHK90H	
<b>Security Box (G, T)</b> (Select by Hat Shelf depth)	30	18	12	6ACXHK91H	
	36	18	12	6ACXHK92H	
	18	24	12	6ACXHK59H	
	24	24	12	6ACXAB93H	
	30	24	12	6ACXAB94H	
	36	24	12	6ACXAB95H	
	42	24	12	6ACXAB96H	
	48	24	12	6ACXAB97H	
<b>Drawer Unit - Requires Bottom Shelf (G, T)</b>	12	15	12	6ACXAB98H	
	24	15	12	6ACXAB99H	
	12	21	12	6ACXHM53H	
	24	21	12	6ACXHM54H	
<b>Drawer Unit for 18" Wide</b> Used when ordering an 18" wide Patriot locker and one 18" drawer unit is required.	18	18	12	6ACXHN70C	
	18	24	12	6ACXHN10C	
	18	18	15	6ACXHN80C*	
	18	24	15	6ACXHN20C*	
<b>18" Drawers for 36" &amp; 42" Wide</b> Used when ordering a 36" wide Patriot locker & either one 18" drawer or two 18" drawer units are required.	18	18	12	6ACXFF82C	
	18	24	12	6ACXFF60C	
	18	18	15	6ACXFF87C*	
	18	24	15	6ACXFF20C*	
<b>Drawer Unit for 24", 30", 42" &amp; 48" Wide</b> 48" wide drawer units consist of two 24" wide drawers. A 24" wide drawer can be combined with an 18" wide drawer (above) in a 42" wide Patriot locker. If a 45" high Center Partition & Metal Bottom Shelf are used, select the 12" high drawer.	24	18	12	6ACXFF83C	
	30	18	12	6ACXFF84C	
	24	18	15	6ACXFF88C*	
	30	18	15	6ACXFF89C*	
	24	24	12	6ACXFF61C	
	30	24	12	6ACXFF62C	
	24	24	15	6ACXFF21C*	
	30	24	15	6ACXFF22C*	

\* 15" high Drawer Units are not for use with Center Divider

Description		W	D	H	Cat. No.
<b>Drawer Divider (G, T)</b> (Two required for Hanging File Folders)	18	-	12	6ACXAB80C	
	24	-	12	6ACXAB81C	
	30	-	12	6ACXAB82C	
	18	-	15	6ACXAB83C	
	24	-	15	6ACXAB84C	
<b>Document Sleeves (G, T, D)</b>	30	-	15	6ACXAB85C	
	12	3	8	6ACXFF54C	
<b>Parachute / Body Armor Rack (G, T)</b>	10	3	8	6ACXAB32C	
	-	18	-	6ACXAB33C	
<b>Adhesive Acrylic Mirror (G, T, D)</b>	6	-	8	96370	
<b>Cell Phone/Key Tray (G, T, D)</b>	8	2	2	60830H	
<b>Heavy Duty Coat Hook (G, T, D)</b>	-	2	3	6ACXAB37H	
<b>Coat Rods (G, T)</b> 1" Diameter, shelf mount only (with light gray brackets)	9	-	-	6ACXHM50H	
	12	-	-	6ACXAB38H	
	15	-	-	6ACXAB39H	
	18	-	-	6ACXAB40H	
	21	-	-	6ACXAB41H	
	24	-	-	6ACXAB42H	
	30	-	-	6ACXAB43H	
	36	-	-	6ACXAB44H	
	42	-	-	6ACXAB45H	
	48	-	-	6ACXAB46H	
<b>Garment Separators (G, T)</b>	12	-	5	6ACXFF00H	
	15	-	5	6ACXFF01H	
	18	-	5	6ACXFF02H	
	21	-	5	6ACXFF03H	
	24	-	5	6ACXFF04H	
	30	-	5	6ACXFF05H	
	36	-	5	6ACXFF06H	
	42	-	5	6ACXFF07H	
<b>Boot Tray ** (G, T, D)</b>	48	-	5	6ACXFF08H	
	14	12	-	6ACXFF09H	
<b>Accessory Mounting Plate (G, D)</b> (To mount accessories to left side door)	12	-	24	6ACXFF10H	
	15	-	24	6ACXFF11H	
	18	-	24	6ACXFF12H	
	21	-	24	6ACXFF13H	
<b>Hardwood Bench Seat, must be purchased separately (G, T)</b> (Not for use with Center Divider)	24	-	24	6ACXFF14H	
	18	18	-	6RQ1317BH	
	24	18	-	6RQ1305BH	
	30	18	-	6RQ1306BH	
	36	18	-	6RQ1307BH	
	18	24	-	6RQ1318BH	
	24	24	-	6RQ1232BH	
	30	24	-	6RQ1233BH	
<b>Metal Seat (G, T)</b> (Not for use with Center Divider)	36	24	-	6RQ1234BH	
	42	24	-	6RQ1235BH	
	48	24	-	6RQ1236BH	
	18	18	-	6ACXHM51H	
	24	18	-	6ACXHK97AH	
	30	18	-	6ACXHK98AH	
	36	18	-	6ACXHK99AH	
	18	24	-	6ACXHM52H	
<b>Name Card Holder (G, D)</b>	24	24	-	6ACXFF49AH	
	30	24	-	6ACXFF50AH	
	36	24	-	6ACXFF51AH	
	42	24	-	6ACXFF52AH	
	48	24	-	6ACXFF53AH	

\*\* When a Boot Tray is used in a DUTY locker, it must be a 24 inch wide locker ONLY.



# Rapid Response Duffel Lockers™

## First Responder Lockers

### At a Glance

- Knocked Down construction, shipped unassembled, assembly available
- Heavy duty 14 gauge doors with continuous hinges, 16 gauge body, 18 gauge back
- Heavy duty Cremone handle with 3-point latching
- Door and Frames 30", 36", 42" and 48" wide, the doors ship separate from frame to be field installed with rivets
- On 48" wide lockers, backs supplied as two 24" wide backs

### Ventilation Options



Diamond Shaped (S)



Solid Door (O)



Full Louvers (O)

### Door Handle Options



Cremone 3 Point (S)

S = Standard  
O = Optional\*

\*additional charges may apply

Specifications can be found in the Penco Lockers catalog or on [pencoproducts.com](http://pencoproducts.com).

### When Every Second Counts™

The Rapid Response Duffel Locker is designed to meet the needs of first responders for the secure and economical storage of their gear. Whether called to action or waiting for their return, these lockers will keep users' belongings and gear safe and ready for that critical first response.

- Individually locked compartments for quick user access
- Sized to fit pre-loaded and oversized TA-50 duffel bags and backpacks and cases
- Lockers will be provided as individual units for ease of mobility and relocation as the mission demands

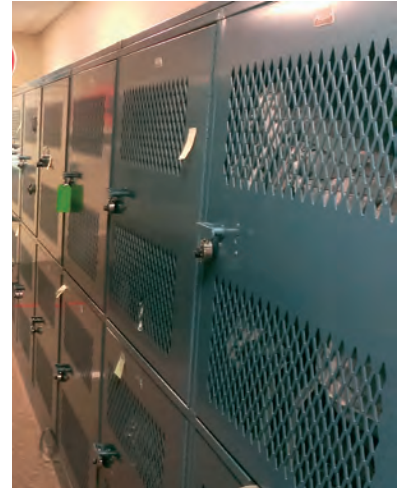

Two Tier



Three Tier



Four Tier

# Rapid Response Duffel Lockers™

## First Responder Lockers

Rapid Response Duffel Lockers												
Overall Height				2 Tier			3 Tier			4 Tier		
				72"	78"	84"	72"	78"	84"	72"	78"	84"
W	D	Division	Door	Cremone Handle			Cremone Handle			Cremone Handle		
24"	24"	Solid	Solid	6KF2A2472	6KF2A2478	6KF2A2484	6KF3A2472	6KF3A2478	6KF3A2484	6KF4A2472	6KF4A2478	6KF4A2484
30"	24"	Solid	Solid	6KF2A3072	6KF2A3078	6KF2A3084	6KF3A3072	6KF3A3078	6KF3A3084	6KF4A3072	6KF4A3078	6KF4A3084
36"	24"	Solid	Solid	6KF2A3672	6KF2A3678	6KF2A3684	6KF3A3672	6KF3A3678	6KF3A3684	6KF4A3672	6KF4A3678	6KF4A3684
42"	24"	Solid	Solid	6KF2A4272	6KF2A4278	6KF2A4284	6KF3A4272	6KF3A4278	6KF3A4284	6KF4A4272	6KF4A4278	6KF4A4284
48"	24"	Solid	Solid	6KF2A4872	6KF2A4878	6KF2A4884	6KF3A4872	6KF3A4878	6KF3A4884	6KF4A4872	6KF4A4878	6KF4A4884
24"	24"	Solid	Louver	6KF2B2472	6KF2B2478	6KF2B2484	6KF3B2472	6KF3B2478	6KF3B2484	6KF4B2472	6KF4B2478	6KF4B2484
30"	24"	Solid	Louver	6KF2B3072	6KF2B3078	6KF2B3084	6KF3B3072	6KF3B3078	6KF3B3084	6KF4B3072	6KF4B3078	6KF4B3084
36"	24"	Solid	Louver	6KF2B3672	6KF2B3678	6KF2B3684	6KF3B3672	6KF3B3678	6KF3B3684	6KF4B3672	6KF4B3678	6KF4B3684
42"	24"	Solid	Louver	6KF2B4272	6KF2B4278	6KF2B4284	6KF3B4272	6KF3B4278	6KF3B4284	6KF4B4272	6KF4B4278	6KF4B4284
48"	24"	Solid	Louver	6KF2B4872	6KF2B4878	6KF2B4884	6KF3B4872	6KF3B4878	6KF3B4884	6KF4B4872	6KF4B4878	6KF4B4884
24"	24"	Solid	Diamond	6KF2C2472	6KF2C2478	6KF2C2484	6KF3C2472	6KF3C2478	6KF3C2484	6KF4C2472	6KF4C2478	6KF4C2484
30"	24"	Solid	Diamond	6KF2C3072	6KF2C3078	6KF2C3084	6KF3C3072	6KF3C3078	6KF3C3084	6KF4C3072	6KF4C3078	6KF4C3084
36"	24"	Solid	Diamond	6KF2C3672	6KF2C3678	6KF2C3684	6KF3C3672	6KF3C3678	6KF3C3684	6KF4C3672	6KF4C3678	6KF4C3684
42"	24"	Solid	Diamond	6KF2C4272	6KF2C4278	6KF2C4284	6KF3C4272	6KF3C4278	6KF3C4284	6KF4C4272	6KF4C4278	6KF4C4284
48"	24"	Solid	Diamond	6KF2C4872	6KF2C4878	6KF2C4884	6KF3C4872	6KF3C4878	6KF3C4884	6KF4C4872	6KF4C4878	6KF4C4884
24"	24"	Diamond	Solid	6KF2D2472	6KF2D2478	6KF2D2484	6KF3D2472	6KF3D2478	6KF3D2484	6KF4D2472	6KF4D2478	6KF4D2484
30"	24"	Diamond	Solid	6KF2D3072	6KF2D3078	6KF2D3084	6KF3D3072	6KF3D3078	6KF3D3084	6KF4D3072	6KF4D3078	6KF4D3084
36"	24"	Diamond	Solid	6KF2D3672	6KF2D3678	6KF2D3684	6KF3D3672	6KF3D3678	6KF3D3684	6KF4D3672	6KF4D3678	6KF4D3684
42"	24"	Diamond	Solid	6KF2D4272	6KF2D4278	6KF2D4284	6KF3D4272	6KF3D4278	6KF3D4284	6KF4D4272	6KF4D4278	6KF4D4284
48"	24"	Diamond	Solid	6KF2D4872	6KF2D4878	6KF2D4884	6KF3D4872	6KF3D4878	6KF3D4884	6KF4D4872	6KF4D4878	6KF4D4884
24"	24"	Diamond	Louver	6KF2E2472	6KF2E2478	6KF2E2484	6KF3E2472	6KF3E2478	6KF3E2484	6KF4E2472	6KF4E2478	6KF4E2484
30"	24"	Diamond	Louver	6KF2E3072	6KF2E3078	6KF2E3084	6KF3E3072	6KF3E3078	6KF3E3084	6KF4E3072	6KF4E3078	6KF4E3084
36"	24"	Diamond	Louver	6KF2E3672	6KF2E3678	6KF2E3684	6KF3E3672	6KF3E3678	6KF3E3684	6KF4E3672	6KF4E3678	6KF4E3684
42"	24"	Diamond	Louver	6KF2E4272	6KF2E4278	6KF2E4284	6KF3E4272	6KF3E4278	6KF3E4284	6KF4E4272	6KF4E4278	6KF4E4284
48"	24"	Diamond	Louver	6KF2E4872	6KF2E4878	6KF2E4884	6KF3E4872	6KF3E4878	6KF3E4884	6KF4E4872	6KF4E4878	6KF4E4884
24"	24"	Diamond	Diamond	6KF2F2472	6KF2F2478	6KF2F2484	6KF3F2472	6KF3F2478	6KF3F2484	6KF4F2472	6KF4F2478	6KF4F2484
30"	24"	Diamond	Diamond	6KF2F3072	6KF2F3078	6KF2F3084	6KF3F3072	6KF3F3078	6KF3F3084	6KF4F3072	6KF4F3078	6KF4F3084
36"	24"	Diamond	Diamond	6KF2F3672	6KF2F3678	6KF2F3684	6KF3F3672	6KF3F3678	6KF3F3684	6KF4F3672	6KF4F3678	6KF4F3684
42"	24"	Diamond	Diamond	6KF2F4272	6KF2F4278	6KF2F4284	6KF3F4272	6KF3F4278	6KF3F4284	6KF4F4272	6KF4F4278	6KF4F4284
48"	24"	Diamond	Diamond	6KF2F4872	6KF2F4878	6KF2F4884	6KF3F4872	6KF3F4878	6KF3F4884	6KF4F4872	6KF4F4878	6KF4F4884

# Steel Lockers

## Accessories

The illustration below shows several locker groups with frequently ordered accessories.

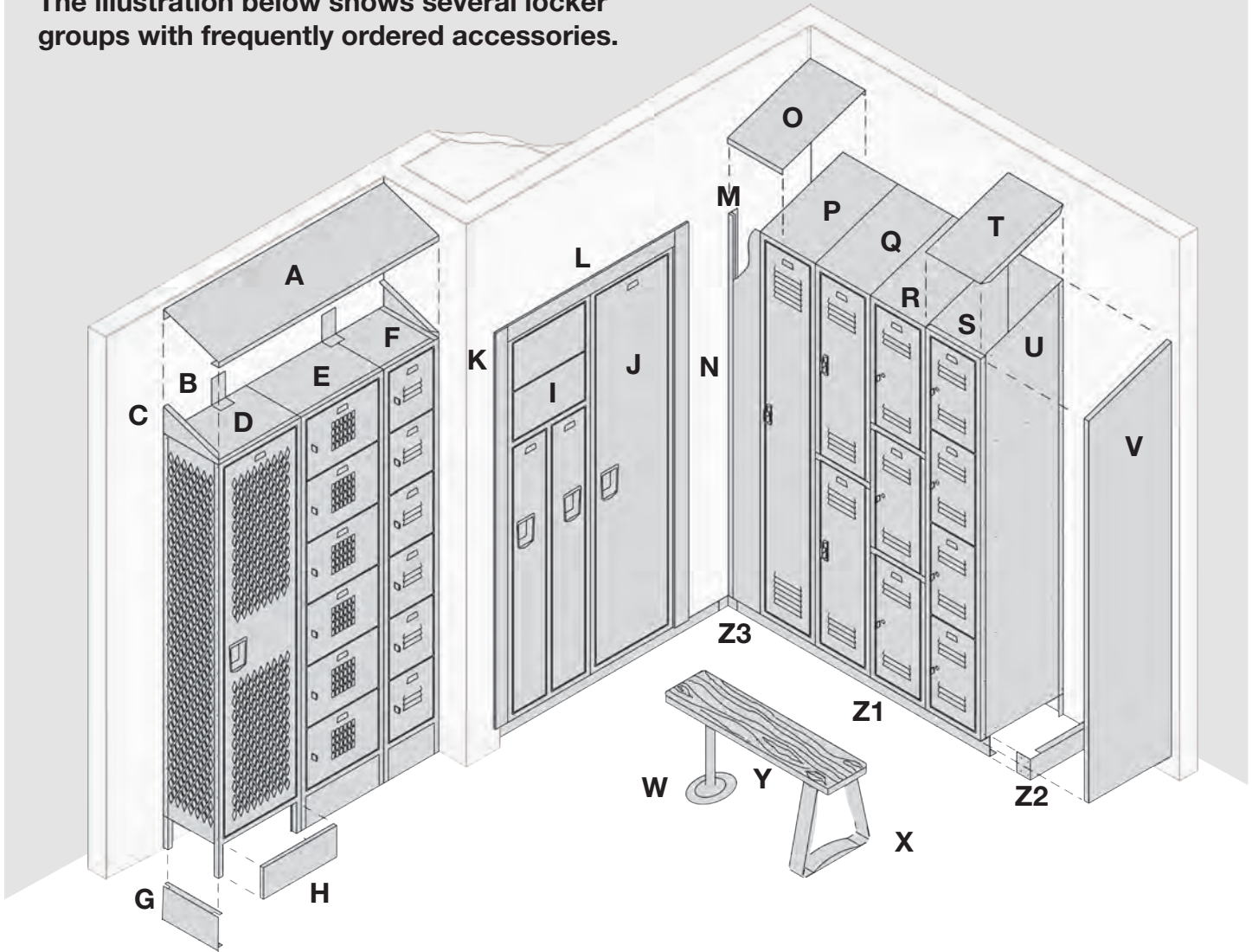

### Key for Illustration

- |   |                                 |   |
|---|---------------------------------|---|
| <b>A.</b> Slope Hood                          | <b>J.</b> Single Tier Guardian  | <b>T.</b> Slope Top, Unit Construction    |
| <b>B.</b> Universal Rear Hood Support         | <b>K.</b> Side Recess Trim      | <b>U.</b> Slope Top Division (Side)       |
| <b>C.</b> Slope End for Hood L.H. (Left Hand) | <b>L.</b> Top Recess Trim       | <b>V.</b> Finished End Panel (Right Hand) |
| <b>D.</b> Single Tier Invincible              | <b>M.</b> Wall Angle Slip Joint | <b>W.</b> Heavy Duty Bench Pedestal       |
| <b>E.</b> 6 Tier Box Locker w/Visual Doors    | <b>N.</b> Vertical Filler       | <b>X.</b> Stainless Steel Bench Pedestal  |
| <b>F.</b> 6 Tier Box Locker w/Std. Louvers    | <b>O.</b> Filler, Slope Top     | <b>Y.</b> Hardwood Bench                  |
| <b>G.</b> End Base, 6" High                   | <b>P.</b> Single Tier Vanguard  | <b>Z1.</b> Zee Base, 4" high              |
| <b>H.</b> Front Base, 6" High                 | <b>Q.</b> Double Tier Vanguard  | <b>Z2.</b> Zee End Base/Splice            |
| <b>I.</b> Two Person Guardian                 | <b>R.</b> Three Tier Vanguard   | <b>Z3.</b> Zee Inside Corner Splice       |
|   | <b>S.</b> Four Tier Vanguard    |   |

### Locker "Growth"

When planning an installation of KD lockers, allow an additional 1/16" for each frame. When planning an installation of Welded lockers, allow an additional 1/16" per group. For Angle Iron lockers, contact your Penco representative.



# Steel Lockers

## Accessories

### Slope Top Construction

Slope tops are often used instead of flat tops to prevent the accumulation of dust and debris, and to discourage the use of locker tops as storage areas. There are three different types of slope top construction: Unit Slope Tops, Slope Hoods, and Slope Top Kits. Each is explained below.

### Unit Slope Tops



Unit Slope Tops cover the width of one locker frame only. Lockers with Unit Slope Tops have sides with mitered top ends with a rise equal to 1/3 of the locker depth, plus longer backs

that meet the rear edge of the slope top. Unit slope tops are used in place of the standard flat tops. Order the appropriate locker plus the proper slope top size. Not for use on Invincible II, Welded, Stadium or Patriot lockers.

### Slope Top Kits



Designed to convert stock flat top lockers into slope top lockers in groups of 3 wide. Each kit contains 3 tops, 3 backs and 4 ends. Not for use on Invincible II, Welded, Stadium or

Patriot lockers.

### Universal Rear Hood Support

Used with 12", 15" 18", 21" and 24" deep hood only.

### Continuous Slope Hoods

Continuous slope hoods fit on top of flat top lockers. They can be used on new lockers or on a retrofit basis. All hoods are furnished in 72" lengths and must be cut to length during installation. Intermediate splices and hood ends complete the installation and must be ordered separately. Hoods comes with 2 rear supports, if extra supports are needed, order separately.

Unit Slope Tops		
Unit Width	Unit Depth	Cat. No.
9"	12"	60332C
	15"	60334C
	18"	60336C
12"	12"	60338C
	15"	60340C
	18"	60342C
15"	21"	60344C
	12"	603450C
	15"	60346C
	18"	60348C
18"	21"	60350C
	18"	60352C
	21"	60354C
24"	24"	60356C
	18"	60364C
	21"	60366C
	24"	60368C

Slope Top Kits - 3 Wide			
Unit Width	Unit Depth	Unit Height	Cat. No.
12"	12"	4"	60230H
	15"	5"	60232H
	18"	6"	60234H
15"	15"	5"	60238H
	18"	6"	60240H
18"	18"	6"	60244H

Slope Hoods*			
Unit Depth	Unit Height	Unit Width	Cat. No.
12"	5"	72"	66144H
15"	6"	72"	66147H
18"	7"	72"	66150H
21"	8"	72"	66153H
24"	9"	72"	66156H

\*Includes 1 piece of hood and 2 hood supports.

Slope Ends			
Unit Depth	Unit Height	Left Hand Cat. No.	Right Hand Cat. No.
12"	5"	66158H	66159H
15"	6"	66160H	66161H
18"	7"	66162H	66163H
21"	8"	66164H	66165H
24"	9"	66166H	66167H

Hood Splice		
Unit Depth	Unit Height	Cat. No.
12"	5"	66168C
15"	6"	66169C
18"	7"	66170C
21"	8"	66171C
24"	9"	66172C

Continuous Slope Hoods			
Unit Length	Unit Depth	Unit Height	Cat. No.
72"	13"	5.3"	6HDX330H
	16"	6.3"	6HDX124H
	19"	7.3"	6HDX471H

Use only when lockers need to be 1 inch away from wall. Includes 1 piece of hood and 2 hood supports. Do NOT use with STANDARD size Slope Ends, Slope Top Corner Fillers, Hip Fillers or Finished End Panels. See special Splices & Hood Supports for these hoods below.

Continuous Slope Splice	
Unit Depth	Cat. No.
13"	6HDX484C
16"	6HDX127C
19"	6HDX473C

Continuous Slope Supports	
Unit Height	Cat. No.
5.3"	6HDX480C
6.3"	6HDX481C
7.3"	6HDX474C

Continuous Hood Ends			
Left/Right	Unit Depth	Unit Height	Cat. No.
LH	13"	5.3"	6HDX642H
RH	13"	5.3"	6HDX643H
LH	16"	6.3"	6HDX125H
RH	16"	6.3"	6HDX126H
LH	19"	7.3"	6HDX694H
RH	19"	7.3"	6HDX695H

### Typical Slope Hood Installation

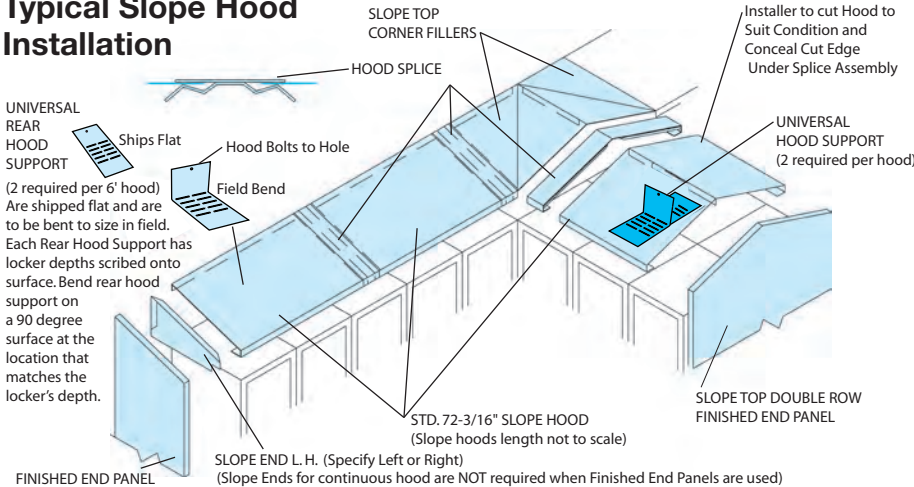

# Steel Lockers

## Accessories

### Individual Closed Bases

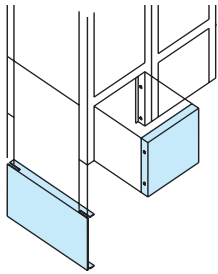

Front and end bases are designed to fit between standard Penco 6" legs. They present a clean flush appearance and prevent the accumulation of dust and dirt under the lockers. Front Base snaps in; End Base slips over legs during locker assembly. Only available for knocked down lockers with 6" legs.

### Zee Bases

Zee bases raise lockers without legs 4" off the floor when there is no concrete or wood base. They provide a toe space in the front and a concealed flange for floor anchoring at the rear. A special 4" high rear leg can be ordered to support the back of the locker. (6" high zee bases are also available.)

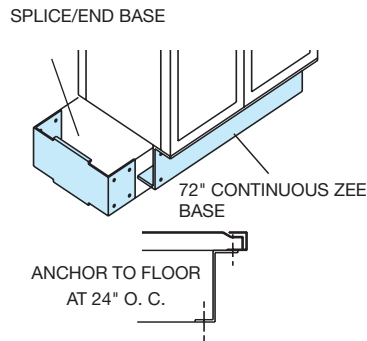

Zee bases are available only in 72" lengths, and may need to be cut to fit at the time of installation. Splices/End Bases are used at ends of rows, and where the front sections join. Not for use on Welded, Stadium or Patriot lockers.

### Fillers

Penco provides standard fillers to adapt lockers to a wide range of field conditions and provide a professional, finished appearance. Fillers can be used to cover columns, pipes or other obstacles in a row of lockers, or fill the gap between the lockers and a wall.

**Vertical Fillers.** These come in three widths and are designed to be used in conjunction with Wall Angle Slip Joints for a solid fit and smooth finish. The slip joint conceals any raw edges caused by field cutting. Additional sizes are available. (Illustration at right.)

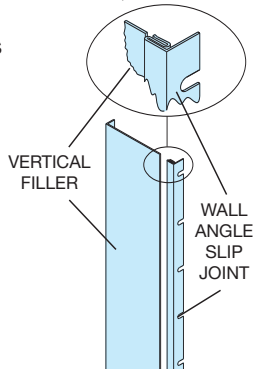

**Top Fillers.** Top Fillers cover gaps between tops of lockers. They overlap the locker tops and can be field cut to allow for pipes, etc. There are separate designs for flat top and slope top, and in-line vs. corner applications (illustration below).

Slope Top Fillers are not to be used with slope hoods. Slope Top Corner fillers can be used with Slope Hoods or Unit Slope Tops

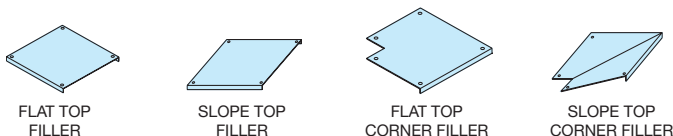

### Individual Closed Bases - 6" High

Unit Width	Unit Depth	Cat. No.
<b>Front Bases</b>		
9"	-	60216C
12"	-	60217C
15"	-	60218C
18"	-	60219C
24"	-	60220C
<b>End Bases Single Row</b>		
-	12"	60204C
-	15"	60205C
-	18"	60206C
-	21"	60207C
-	24"	60208C
<b>End Bases Double Row</b>		
-	24"	60209C
-	30"	60210C
-	36"	60211C

### Zee Bases - 72" Width

Unit Depth	Unit Height	Cat. No.
<b>Front Zee Bases</b>		
-	4"	66700H
<b>Splice/End Base Single Row</b>		
12"	4"	66701H
15"	4"	66702H
18"	4"	66703H
21"	4"	66704H
24"	4"	66705H
<b>Splice/End Base Double Row</b>		
30"	4"	66707H
24"	4"	66706H
36"	4"	66708H
<b>Zee Inside Corner Splice</b>		
-	4"	66709H
<b>Rear Leg for Zee Base</b>		
-	4"	60092C

### Vertical Fillers

Unit Width	Unit Height	Cat. No.
<b>Vertical Angles</b>		
5"	60"	66112C
	72"	66115C
9"	60"	66114C
	72"	66117C
	78"	66127C
12"	60"	66113C
	72"	661141C
	78"	66116C
<b>Wall Angle Slip Joints</b>		
-	60"	66118C
-	72"	66119C
-	78"	66121C

### Top Fillers

Unit Width	Unit Depth	Cat. No.
<b>Flat Top Fillers</b>		
15"	12"	661321C
	15"	661322C
	18"	661323C
<b>Slope Top Fillers</b>		
15"	12"	661371C
	15"	661372C
	18"	661373C
<b>Flat Top Corner Fillers</b>		
12"	12"	66138C
15"	15"	66139C
18"	18"	66140C
<b>Slope Top Corner Fillers</b>		
12"	12"	66100C
15"	15"	66101C
18"	18"	66102C

# Steel Lockers

## Accessories

### Extra Steel Locker Shelves



Extra locker shelves can be added to K.D. lockers to meet special user requirements. Most lockers have extra holes already punched into side panels for mounting. In some cases shelf mounting holes may need to be drilled. Please consult your Penco sales representative for shelf mounting requirements.

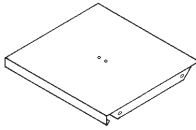

Pictured: Single Tier Vanguard Locker with 5 shelves.

### Recess Trim

Recess trim is 3" wide and bridges the gap between lockers and wall and/or soffits when the lockers are recessed into a wall. Side trim for left hand (LH) and right hand sides (RH) are different. Side Trim comes in three types: 1) for use with lockers with no legs, 2) with 6" legs and 3) for use with Bottom Recess Trim.

The soffit is to be constructed by general contractor. Face of soffit must be flush with face of locker. There should be 1" between top of locker and bottom of soffit. The recessed trim extends 3/8" from face of soffit.

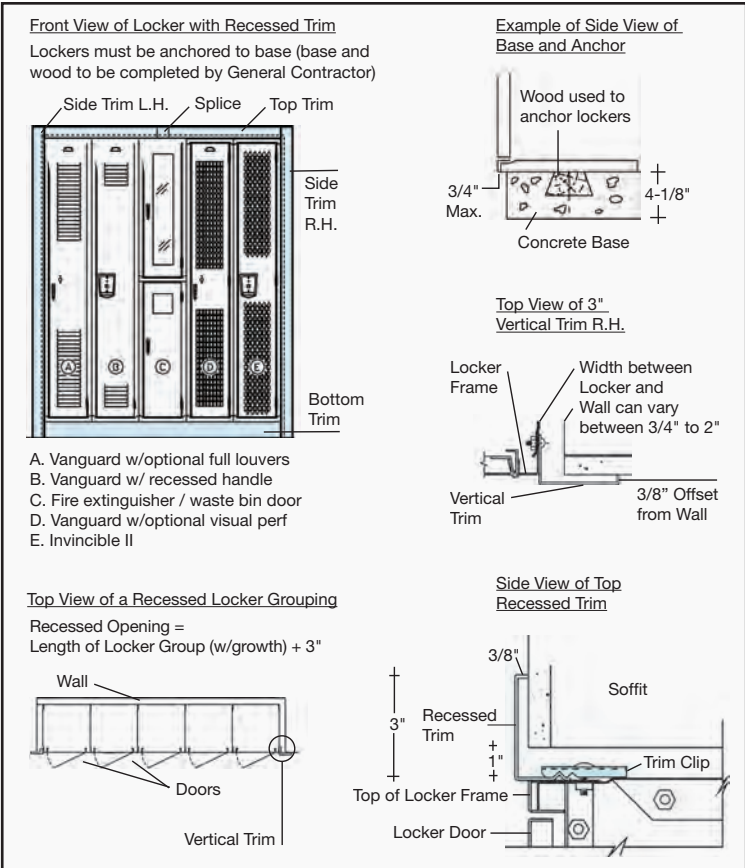

Recess Trim - 3" High		
Unit Width	Unit Depth	Cat. No.
Top Trim		
74"	-	60456H
Splice		
2"	-	66105C
Outside Corner Splice		
2"	2"	66108C
Bottom Trim		
72"	-	60458C

Recess Side Trim - 3" Wide	
Unit Height	Cat. No.
Side Trim - LH (Use with lockers that have No Legs)	
63"	60465C
75"	60469C
87"	60473C
Side Trim - RH (Use with lockers that have No Legs)	
63"	60466C
75"	60470C
87"	60474C
Side Trim - LH (Use with Top Trim & 6" Legs)	
69"	60467C
81"	60471C
93"	60475C
Side Trim - RH (Use with Top Trim & 6" Legs)	
69"	60468C
81"	60472C
93"	60476C
Side Trim - LH (Use with Top & Bottom Trim)	
66"	60477C
78"	60479C
90"	60481C
Side Trim - RH (Use with Top & Bottom Trim)	
66"	60478C
78"	60480C
90"	60482C

# Steel Lockers

## Accessories

### Locking System Options

**Built-in Key Locks.** Available in flat key or grooved key models. Dead bolt and spring bolt construction. Reversible for LH & RH applications.

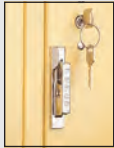

**Built-in Combination Locks.** Available with five combination changes for security year to year. Master key controlled. Stainless steel escutcheon plate. Use dead bolt models for all but box lockers, which use spring bolt. Available in LH & RH.



**Combination Padlocks.** Available with and without master keying. 3 number dialing. Rust resistant. Fits box lockers, Die-Cast Handles, recessed handles, cremone handles and basket racks.

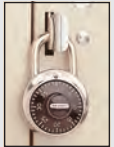

**Note:** For proper fit and security, padlock shackle must have a diameter of 9/32" or 5/16" and a distance of .75" to .81" between the top of the case and the underside of the shackle when in the locked position.

**Coin Operated.** Ideal for public or private applications that require security with the assurance that keys will be returned, or as a revenue producer. Fits most Penco lockers. Available in 3 types: coin return, coin collect and token operation. Not available for Defiant lockers.



### ADA Compliant Locks

**Key Lock Model No. 9707.** Just insert key (turning not required) and lift latch pull to open door.



**Key Lock Model No. 9676A.** Has an oversized keyhead to facilitate turning.

**Battery Powered Lock.** ADA compliant lock that opens by touching a Button Key to the lock. When opened, an LED light flashes and audio indicator sounds. Lock uses programming key to set user access and a master key for administrative or management use.



### Benches and Pedestals

A natural accessory for any locker room. Benches add permanent comfort and order to the floor plan arrangement.

Penco offers a choice of bench pedestal styles. Order two pedestals for standard benches 96" long or less; order three pedestals for benches over 96" long. The seat portion of ADA benches require a minimum of 4 pedestals, placed as shown in the photo of the Bench Bracket.

### Hardwood Bench Tops

Exceptionally strong wood locker room benches finished with clear lacquer.

For ADA (Americans With Disabilities Act) compliant benches, use 16" or 18" deep bench backs and 20" or 24" deep seats plus Bench Brackets to support the backs. Order Pedestals separately.

Wood Bench Tops			
Width	Depth	Thickness	Cat. No.
Standard Bench Tops			
36"	9-1/2"	1-1/4"	9611
48"	9-1/2"	1-1/4"	9600
48"	12"	1-1/4"	9622
60"	9-1/2"	1-1/4"	9601
72"	9-1/2"	1-1/4"	9602
84"	9-1/2"	1-1/4"	9603
96"	9-1/2"	1-1/4"	9604
108"	9-1/2"	1-1/4"	9605
120"	9-1/2"	1-1/4"	9606
132"	9-1/2"	1-1/4"	9607
144"	9-1/2"	1-1/4"	9608
ADA Compliant Benches			
42"	16"	1-1/4"	9634
48"	16"	1-1/4"	9635
42"	18"	1-1/4"	9625
48"	18"	1-1/4"	9628
42"	20"	1-1/4"	9636
48"	20"	1-1/4"	9632
42"	24"	1-1/4"	9624
48"	24"	1-1/4"	9623

### A. Heavy Duty Bench Pedestal

16-1/4" high pedestal consists of a heavy duty steel tube welded to top and bottom flanges. Hardware for fastening to the bench only is included. Pedestal must be anchored to the floor. Order two or more per standard bench; four or more for ADA compliant bench. Available for quick shipment in 028 Gray and 073 Champagne. Available on production schedules in all standard colors. Cat. No. 60822H

### B. Stainless Steel Free Standing Pedestal

This pedestal has a 14" wide base which allows for moveable free standing use. Holes in the bottom are provided for optional floor anchoring or for attachment of non-skid bumpers (see below). Hardware is supplied for fastening to the bench top. Height is 16-1/4". Cat. No. 60827H each.



### Non-Skid Pedestal Kit for Stainless Steel Pedestal

Rubber non-skid bumpers to prevent damage to floors. Consists of set of 4 non marking rubber feet and fastening hardware. Order 1 kit per pedestal. Cat. No. 68420

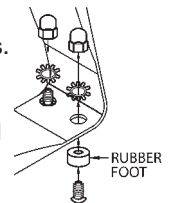

### Bench Bracket for Back of ADA Benches

For attaching 16" or 18" backrest to 20" or 24" deep benches for ADA use. Sturdy steel construction.



Order a minimum of 2 per back. Size is 19" x 19" x 2". Hardware included. Cat. No. 6ACXHP61H

### Mirror

Made of acrylic plastic that will not break in normal usage. Mirror has an adhesive backing for easy installation. Size is 6" wide x 8" high. Cat. No. 96370



# Lockers & Basket Racks

## Basket Racks/Special Purpose Lockers

### Basket Racks



An economical shelving rack specially designed to accommodate wire baskets for storage of athletic apparel, swimming trunks, etc. Ideal for schools, YMCA's, clubs and other organizations with swimming pools and gym facilities.

Penco basket racks' open type construction with 13 ga. posts and 20 gauge shelves permits free circulation of air and easy visual inspection. Stability is achieved through the use of 12 ga. cross braces. 3" high 20 ga. dividers

between baskets and at ends of rows make basket contents inaccessible from adjacent openings.

Backs of shelves are turned down to form a backstop to prevent baskets from being removed from the rear. Aluminum number plates with 3/8" high black letters and 14 gauge padlock hasp are furnished for each opening and fasten to the front edge of the shelf. Number plate sequence must be specified when ordering. Units may be bolted together to form a double faced rack. Racks are 40" wide x 13-3/16" deep. Units can be equipped with casters. Order baskets separately.

### Baskets

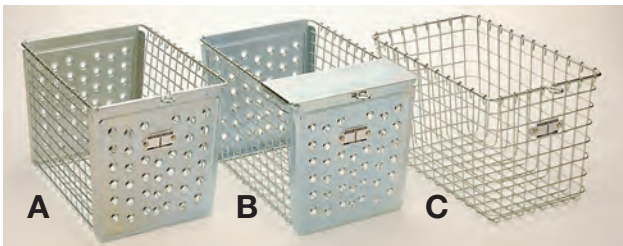

Three styles of baskets are available: **A.** Perforated plate front and rear with wire on sides and bottom; **B.** Same as above, except with "Pilfer Guard", and extra plate that covers the top front of the basket; **C.** All plated wire construction. All are nominally 13" D x 8" H. Baskets can be supplied with number plates corresponding to shelf position. Number sequence must be furnished with the order.

### Food Industry Lockers



For ease of cleaning beneath lockers. Leg extensions increase the 6" height to 16". Order as piece parts or in a kit specially designed for 18" deep lockers. Kits include supports for a hardwood bench (order bench separately). Lockers must have standard 6" legs. Not for use with Welded, Stadium or Patriot lockers.

### Fire Extinguisher Door and Waste Bin door



Lockers can be designated to contain a fire extinguisher door and/or a waste receptacle. The opening on the fire extinguisher door is glazed with wire-reinforced glass.

Waste bin doors have a cut-out with an internal flap and a top spring-loaded hinge to keep the opening closed when not being used. There is a small metal chute inside the door to direct the waste to a waste container (container is not included).

These items are typically ordered in 12" or 15" wide 1 and 2 tier lockers. If recessed handles are used, the width must be a minimum of 15" wide. Locks should not be used on fire extinguisher doors or waste bin doors.

#### Basket Racks

Levels/ Basket Capacity	Unit Width	Unit Depth	Unit Height	Cat. No.
<b>9" Wide Baskets, 4 Baskets Wide</b>				
7/28	40"	13"	70"	65910
8/32	40"	13"	79"	65930
<b>12" Wide Baskets, 3 Baskets Wide</b>				
7/21	40"	13"	70"	65800
8/24	40"	13"	79"	65830

#### Baskets

Unit Width	Unit Depth	Unit Height	Cat. No.
<b>A. Perforated Front</b>			
9"	13"	8"	9646
12"	13"	8"	9641
<b>B. Perforated Front w/ Pilfer Guard</b>			
9"	13"	8"	9642
12"	13"	8"	9643
<b>C. All Wire</b>			
9"	13"	8"	9621
12"	13"	8"	9620

#### Food Industry Locker Conversion

Unit Width	Unit Depth	Unit Height	Cat. No.
<b>Kits, 18" Depth</b>			
1 Wide	-	16"	64001
3 Wide	-	16"	64003
<b>Rear Leg</b>			
-	-	16"	65540H
<b>Bench Support</b>			
-	18"	-	65541H
<b>End Front Leg</b>			
-	-	16"	65542H
<b>Intermediate Front Leg</b>			
-	-	16"	65543H

# Lockers

## Defiant™ II Single Point Latch (SPL)/ADA

### The Single Point Alternative

- Greater tamper resistance
- Increased rigidity
- Improved Performance with built-in locks



The Defiant II Single Point Latch (SPL) option is for those desiring a heavy gauge door offering improved security with the low maintenance inherent in a door with no moving parts.

Each door has a patented deep drawn stainless steel pocket handle with an integral door pull. The doors can be locked with a conventional padlock, using the padlock staple protruding through the recessed handle (recommended) or with a built-in lock.

Doors are stiffened with either a vertical or horizontal pan, as shown at the right.

**Bracket Support.** The padlock hasp is strengthened for greater tamper resistance on KD and Welded lockers as shown below.



For KD Lockers



For Welded Lockers



Vertical Pan



Horizontal Pan

### Anti-Pry/Lock Alignment Bracket

Defeats prying attempts by capturing the door flange and preventing separation from the door channel.



### Side Stiffener

This full-depth stiffener prevents frame channel and side-sheet torquing during break-in attempts. For use at left ends of 24 gauge Guardian K.D. bodies of 1 & 2 tier lockers with combination locks only.



Defiant II 1-tier lockers with built-in combination locks, finished end panels and custom flat tops.



Defiant II 2-tier All-Welded lockers with slope hoods, finished end panels and custom bases & benches.

### Americans with Disabilities Act Information (ADA) and Lockers

Penco lockers commonly accepted for ADA or barrier-free assignments are single tier and double-tier (lower tier only) when equipped with the Classic III recessed handle with multi-point latching: Vanguard, Guardian, Invincible II, All-Welded and Angle Iron (with available modifications). Other handle types and certain lock selections may not be recognized as ADA compliant without modification.

Single tier 60" or 72" high lockers with the Classic III recessed multi-point latch handles must have shelves relocated and/or added to accommodate ADAAG mandated reach ranges. Two tier 36" high openings with the Classic III recessed handle may be used by designating the lower tier for ADA compliance. An extra shelf should be ordered to bring the lowest reach point within the prescribed ADAAG range based upon side or forward reach. We recommend field drilling for these shelf locations on smaller requirements. The owner or architect may also require a handicapped access sign be placed on the door.



Other handles and configurations may sometimes be specified, but those above are the most appropriate based upon a literal interpretation. Attention should also be paid to the clear area in front of the lockers to meet other separate but related guidelines. Contact your factory representative for assistance, or go to [www.access-board.gov](http://www.access-board.gov) for a complete text of the ADA Accessibility guidelines.



ADA locker can optionally be marked with a decal.



ADA locker has shelf at least 15 inches from floor.

# Color Chart

## 24 Designer Colors



NOTE: Colors shown are as close to actual finishes as the printing process allows. Do not make your final color selection based on the color shade shown on this page. Penco Color Charts are available for a more accurate color match. Exposure to high humidity, chlorine salts, abrasive cleaners, germicidal cleaners and acids can damage the finish and will void the guarantee. For outdoor applications or other harsh environmental conditions, contact your Penco Representative.

### Standard Colors

To assure rust resistance and paint adhesion, all Penco steel products receive a state of the art pre-paint conditioning that includes a thorough cleansing by a hot spray washing process, then a specially formulated coating is applied creating a surface that resists corrosion and improves paint adhesion. Virtually all steel products are available in the 24 colors shown above.

All Penco locker doors, frames and body parts are painted the same color, as standard.

Two-tone color combinations are also available. Contact your Penco sales representative for complete information.



### Standard Powder Coat Finish

Penco's standard 1 mil thick paint finish is perfect for most applications. The paint surface is tough and durable and offers a beautiful drip-free surface, excellent edge coverage and environmentally friendly application.

### PowderCoatPlus™

PowderCoatPlus is an optional cost-effective way of improving the durability and rust resistance. After a specialized cleaning and pre-treatment of the steel, a 2 mil thick coating of powder coat enamel is applied and baked onto the steel surface.

### X-Off™ Anti-Graffiti Paint

Penco's optional X-Off Anti-Graffiti Paint for lockers provides a surface coating that allows easy removal of graffiti with alcohol and water. This specially formulated paint has a tight molecular structure that completely seals the locker surface, preventing graffiti and corrosive agents from penetrating the finish.



Supplies needed:  
99% isopropyl alcohol, water, cleaning cloths, eye and hand protection.





www.pencoproducts.com

Every customer's first choice to transform space into safe, secure and effective storage.



Lockers



Multi-Level & High Rise Shelving



Wide Span Shelving



RivetRite® Shelving



Garment Lockers • Hygiene Products



Pallet Racks

Textile Rental Industry Products



Cover photo: Clipper® Shelving with Hi-Performance Shelves, page 4

Back cover photo: Guardian™ Defiant II, page 60



This catalog was printed on paper made in the USA.



© Copyright 2016 Penco Products, Inc. StorageCatalog2016.indd/pdf