



STORAGE PRODUCTS

PENCO'S FULL LINE OF STORAGE PRODUCTS



About Penco

The need for storage products is universal and Penco has a broad selection of solutions to fill that need. In doing so, Penco has become one of America's largest and most trusted suppliers of storage and work-area products. With state-of-the-art US manufacturing facilities and QuickShip Distribution Centers strategically located throughout the United States and Canada, Penco is positioned to best serve your needs.

Market sectors served by Penco include educational, healthcare, and government facilities, as well as offices, manufacturing companies, distribution warehouses, retail outlets, sports arenas and community parks.

Shelving and pallet rack products are popular with warehousing and manufacturing applications, ranging from a few units to multi-level and high rise applications.

Lockers are widely used in educational facilities, fitness centers, healthcare, military, emergency response, commercial and industrial locations.

Penco's History

In 1869, a man named L. Lewis Sagendorph fulfilled his ambition to begin his own company that would produce the finest metal products in America. He called his fledgling business the Penn Metal Corporation of Pennsylvania, and began by making steel culvert pipe on Oregon Avenue in South Philadelphia.



Over the years, Penn Metal's product lines broadened to include lockers, shelving and even aircraft landing mats. A reputation for quality fabrication spread, and the company's influence became nationwide. In the 1950's, the name was shortened to Penco Products and the plant and offices were expanded to a modern facility in Oaks, Pennsylvania, near Valley Forge.

In 2001, the manufacturing facility was moved from Oaks to a 475,000 square foot manufacturing facility in Hamilton, North Carolina, allowing significant room for expansion. In 2013, the corporate headquarters was moved from Skippack, Pennsylvania to Greenville, North Carolina.

Headquarters in Greenville, NC



Customer Service

Penco's Customer Service staff is a customer friendly, knowledgeable team that is dedicated to excellence in service delivery and communication. The team is based at Penco's Greenville, NC headquarters.

Our goal is to provide professional, courteous, timely and accurate service to every customer in a fair, consistent and accessible manner. Penco's distributor partners and customers are our number one priority and focus.

pencoproducts.com | 800.562.1000

LEEDS Environmental Information

- Based upon the most recent information from our source mills, the recycled content of our steel lockers can range from 25% to over 50%. Because the percentage of recycled content may vary from project to project based on a number of variables, please contact our offices for detailed information on your specific requirement.
- Powder coating drastically reduces waste through high efficiency application & recovery methods.
- Penco's powder coat paint contains no solvents and as a result releases no Volatile Organic Compounds (VOC's) normally associated with wet paint processes.
- Our packaging contains at least 20% post-consumer recycled content.
- Approximately 34% of the U.S. population lives within a 500 mile radius of our manufacturing facility, requiring less fuel to ship our products to many destinations.



★ Mfg. Plant

Shelving

Clipper Shelving	4
QuickShip Clipper Shelving	17
Wide Span Shelving	19
RivetRite Shelving.....	24
QuickShip RivetRite Shelving	34

Ask for Penco's Erectomatic Shelving catalog

Pallet Rack

Pallet Rack.....	38
------------------	----

Work Platforms

Stairs / Stair Towers	46
Ladders / Handrails.....	47

Lockers

Introduction	48
Vanguard Lockers	50
QuickShip Vanguard Lockers	53
Guardian Lockers	56
Invincible II Lockers.....	58
Welded GEN2 Lockers	60
Stadium Lockers	62
Patriot Lockers.....	64
Locker Accessories	86
Special Purpose Lockers.....	91
Locker Specifications	92
ADA Lockers	114
Color Information	115
Garment Dispensers	116

QuickShip Clipper Shelving.....	17
QuickShip RivetRite Shelving.....	34-35
QuickShip Vanguard Lockers.....	55-57



Locker Program

4 STRATEGIC LOCATIONS



Penco Products leads the industry with its comprehensive QuickShip program. Penco's QuickShip Distribution Centers have been strategically located throughout North America to best serve customer needs with prompt delivery of products from the shortest distance possible. Penco's QuickShip program saves time, delivery cost and energy, thus reducing the impact on our environment.

Visit pencoproducts.com/penco-programs/quickship for a listing of which products are available at each warehouse location shown.



GREENGUARD

All products manufactured by Penco Products are GREENGUARD Gold Certified through UL Environment's GREENGUARD Certification Program. This certification signifies that Penco's products are in compliance with the stringent chemical emissions guidelines set by UL Environment.

Accredited courses are available to design professionals and fulfill credit requirements for AIA, GBCI, IDCEC. Contact a Penco Sales Manager for more information.

Defined

Clipper Hi-Performance Shelving Systems

At the heart of the Clipper Shelving System is the ingenious Penco Clipper Clip. It is easily installed, holds the shelf firmly in place, can be repositioned at any time, and actually helps make the shelving more rigid.

Clipper Shelving features Hi-Performance® Box Beam Shelves, which offer an exceptional strength to weight ratio. Clipper Shelving offers a wide variety of sizes and capacities too. This gives you the flexibility to provide top quality storage for a simple back room area up to a sophisticated multi-level or high-rise application.

Growth with Penco Hi-Performance® Shelves

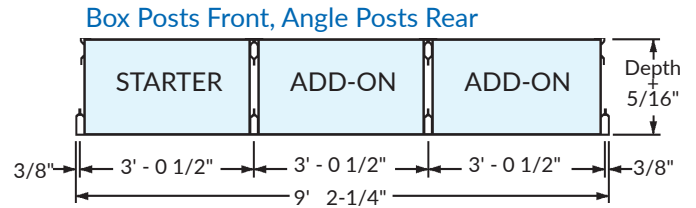

Angle Posts Front & Rear

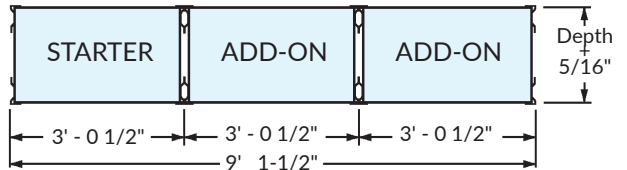

Growth with Clipper Conventional Flange Shelves

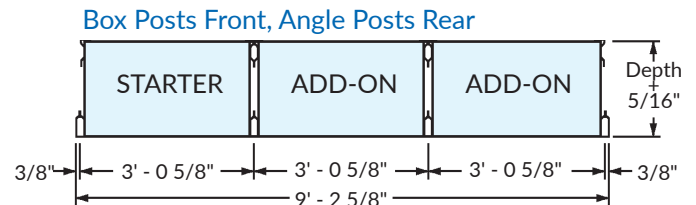

Angle Posts Front & Rear

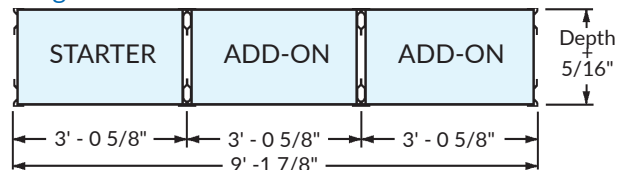

All dimensions are theoretical subject to manufacturing tolerances.

How to Order Clipper Units

Virtually all shelving storage needs may be satisfied by ordering standard shelving units as illustrated on the following pages. These units are shipped KD with all required components, shelf clips, hardware and assembly instructions.

Choice of Post Arrangements

Penco standard shelving units employ box posts at front and offset angle posts at rear for each section. Other post assembly plans may be employed using offset angle posts at front and rear, when ordered as individual component parts.

Growth Dimension Considerations

To determine the overall dimension of a continuous row of shelving employing box and angle posts, refer to detail drawings below.

To order standard 87" high units:

1. Determine the shelving type desired (open, closed or ledge)
2. Determine shelf width and depth.
3. Order by catalog number as many basic units as required to form a continuous row of shelving.
4. Order by catalog number one ending kit to end each row.
5. Select the appropriate accessories for your application.

Clipper Growth Chart
(With box posts at front, angle posts at rear)

No. of Units In a Row	36" Wide Sections	42" Wide Sections	48" Wide Sections
1	3' 1-3/8"	3' 7-3/8"	4' 1-3/8"
2	6' 2"	7' 2"	8' 2"
3	9' 2-5/8"	10' 8-5/8"	12' 2-5/8"
4	12' 3-1/4"	14' 3-1/4"	16' 3-1/4"
5	15' 3-7/8"	17' 9-7/8"	20' 3-7/8"
6	18' 4-1/2"	21' 4-1/2"	24' 4-1/2"
7	21' 5-1/8"	24' 11-1/8"	28' 5-1/8"
8	24' 5-3/4"	28' 5-3/4"	32' 5-3/4"
9	27' 6-3/8"	32' 0-3/8"	36' 6-3/8"
10	30' 7"	35' 7"	40' 7"
11	33' 7-5/8"	39' 1-5/8"	44' 7-5/8"
12	36' 8-1/4"	42' 8-1/4"	48' 8-1/4"
13	39' 8-7/8"	46' 2-7/8"	52' 8-7/8"
14	42' 9-1/2"	49' 9-1/2"	56' 9-1/2"
15	45' 10-1/8"	53' 4-1/8"	60' 10-1/8"
16	48' 10-3/4"	56' 10-3/4"	64' 10-3/4"
17	51' 11-3/8"	60' 5-3/8"	68' 11-3/8"
18	55' 0"	64' 0"	73' 0"
19	58' 0-5/8"	67' 6-5/8"	77' 0-5/8"
20	61' 1-1/4"	71' 1-1/4"	81' 1-1/4"

Open Shelving Units

Open Type Shelving

Open type shelving is the basic and most economical shelving design for general purpose use. Backs and sides are open, except that sections are stabilized by sway braces.

For convenient ordering, 36 different open configurations of Basic Units are shown below with their respective End Kits. The completed units below utilize Heavy Duty Hi-Performance® Shelves with box posts at front and offset angle posts at rear. Label holders are not included. Refer to page 4 for ordering instructions.

Many other configurations can be designed from the component parts and accessories on the following pages.

Basic Unit

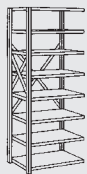

- 1 Box Post
- 2 Angle Posts
- 1 Set Side Braces
- 1 Set Back Sway Braces
- Shelves
- Hardware

End Kit



- 1 Box Post
- 1 Set Side Braces
- Hardware



CLIPPER
SHELVING

Clipper Open Units

Unit Width	Unit Depth	Unit Height	Capacity Per Shelf**	5 Shelf Basic Cat. No.	6 Shelf Basic Cat. No.	7 Shelf Basic Cat. No.	8 Shelf Basic Cat. No.	End Kit Cat. No.
36" Wide Units	12"	87"	800 lb	1H7015	1H7016	1H7017	1H7018	101287
	18"	87"	850 lb	1H7025	1H7026	1H7027	1H7028	101887
	24"	87"	800 lb	1H7035	1H7036	1H7037	1H7038	102487
42" Wide Units	12"	87"	600 lb	1H7045	1H7046	1H7047	1H7048	101287
	18"	87"	600 lb	1H7055	1H7056	1H7057	1H7058	101887
	24"	87"	600 lb	1H7065	1H7066	1H7067	1H7068	102487
48" Wide Units	12"	87"	500 lb	1H7075	1H7076	1H7077	1H7078	101287
	18"	87"	500 lb	1H7085	1H7086	1H7087	1H7088	101887
	24"	87"	530 lb	1H7095	1H7096	1H7097	1H7098	102487

** For Evenly Distributed Load

Closed Shelving Units



Closed Type Shelving

Closed type shelving units are covered on three sides with steel panels to provide stability, protection and to promote cleanliness of stored items. Optional locking doors may be added for greater security.

The 36 configurations shown below with their respective End Kits employ Heavy Duty Hi-Performance® shelves with box posts at the front and offset angle posts at the rear. **Label holders and closed front bases are not included and must be ordered separately.**

Refer to page 4 for ordering instructions. Many other configurations can be designed from the component parts and accessories on the following pages.

Basic Unit



- 1 Box Post
- 2 Angle Posts
- 1 Side Panel
- 1 Back Panel
- Shelves
- Hardware

End Kit



- 1 Box Post
- 1 Side Panel
- Hardware

Clipper Closed Units

Unit Width	Unit Depth	Unit Height	Capacity Per Shelf**	5 Shelf Basic Cat. No.	6 Shelf Basic Cat. No.	7 Shelf Basic Cat. No.	8 Shelf Basic Cat. No.	End Kit Cat. No.
36" Wide Units	12"	87"	800 lb	1H8015	1H8016	1H8017	1H8018	1C1287
	18"	87"	850 lb	1H8025	1H8026	1H8027	1H8028	1C1887
	24"	87"	800 lb	1H8035	1H8036	1H8037	1H8038	1C2487
42" Wide Units	12"	87"	600 lb	1H8045	1H8046	1H8047	1H8048	1C1287
	18"	87"	600 lb	1H8055	1H8056	1H8057	1H8058	1C1887
	24"	87"	600 lb	1H8065	1H8066	1H8067	1H8068	1C2487
48" Wide Units	12"	87"	500 lb	1H8075	1H8076	1H8077	1H8078	1C1287
	18"	87"	500 lb	1H8085	1H8086	1H8087	1H8088	1C1887
	24"	87"	530 lb	1H8095	1H8096	1H8097	1H8098	1C2487

Front Bases must be ordered separately.

36" Wide Bin Units





Clipper Shelving Bin Units are closed units with Heavy Duty Hi-Performance shelves, in various quantities, plus dividers and bin fronts as required. Offset angle posts are used at the rear of each unit, and box posts at the front. Order one End Kit to finish a unit or row of units. **Front bases are included. Label holders must be ordered separately.** This and the following page catalog 36" & 48" wide units, but many other configurations are possible by ordering component parts.

NOTE: Bin widths are nominal. They are measured from the hole centers on the shelves, not the vertical bead of the dividers.

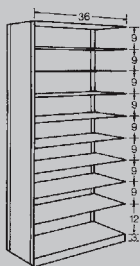

CLIPPER
SHELVING

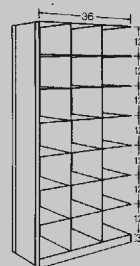
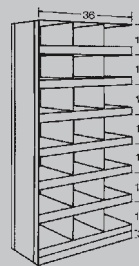



36" Wide Clipper Bin Units

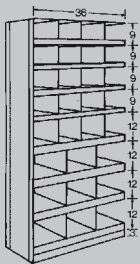
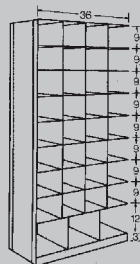
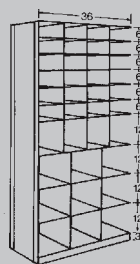
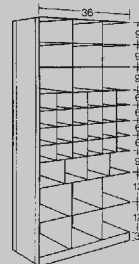

Unit Depth	Unit Height	9 Openings 8 @ 36" x 9" 1 @ 36" x 12"	13 Openings 12 @ 36" x 9" 1 @ 36" x 12"	21 Openings 21 @ 12" x 12"	21 Openings 21 @ 12" x 12" 7 - 3" Bin Fronts	End Kit
		 9 Openings Cat. No.	 13 Openings Cat. No.	 21 Openings Cat. No.	 21 Openings 3" Bin Fronts Cat. No.	 End Kit Cat. No.
12"	87"	1H6109	1H6113	1H6121	1H6621	1C1287
18"	87"	1H6209	1H6213	1H6221	1H6521	1C1887
24"	87"	1H6309	1H6313	1H6321	1H6421	1C2487

36" Wide Clipper Bin Units

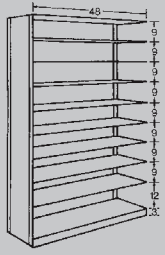
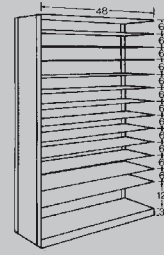
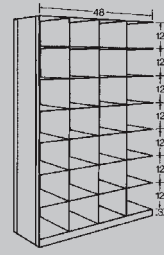
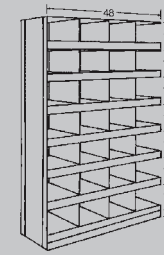
Unit Depth	Unit Height	29 Openings 16 @ 9" x 9" 4 @ 9" x 12" 9 @ 12" x 12" 8 - 3" Bin Fronts	35 Openings 32 @ 9" x 9" 3 @ 12" x 12"	37 Openings 24 @ 9" x 6" 4 @ 9" x 12" 9 @ 12" x 12"	43 Openings 24 @ 6" x 6" 9 @ 12" x 9" 4 @ 9" x 9" 6 @ 12" x 12"	End Kit
		 29 Openings Cat. No.	 35 Openings Cat. No.	 37 Openings Cat. No.	 43 Openings 3" Bin Fronts Cat. No.	 End Kit Cat. No.
12"	87"	1H6129	1H6135	1H6137	1H6143	1C1287
18"	87"	1H6229	1H6235	1H6237	1H6243	1C1887
24"	87"	1H6329	1H6335	1H6337	1H6343	1C2487

48" Wide Bin Units

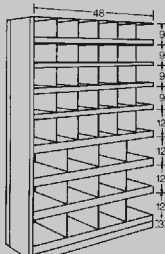
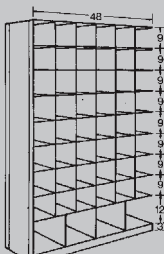
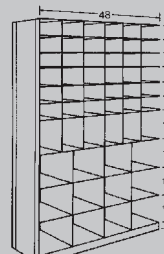
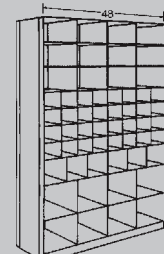
48" Wide Clipper Bin Units						
		9 Openings 8 @ 48" x 9" 1 @ 48" x 12"	13 Openings 12 @ 48" x 6" 1 @ 48" x 12"	28 Openings 28 @ 12" x 12"	28 Openings 28 @ 12" x 12" 7 - 3" Bin Fronts	End Kit
						
Unit Depth	Unit Height	9 Openings Cat. No.	13 Openings Cat. No.	28 Openings Cat. No.	28 Openings 3" Bin Fronts Cat. No.	End Kit Cat. No.
12"	87"	1H6409	1H6413	1H6428	1H6328	1C1287
18"	87"	1H6509	1H6513	1H6528	1H6228	1C1887
24"	87"	1H6609	1H6613	1H6628	1H6128	1C2487

48" Wide Clipper Bin Units						
		42 Openings 16 @ 7-1/2" x 9" 8 @ 9" x 9" 4 @ 7-1/2" x 12" 2 @ 9" x 12" 12 @ 12" x 12" 8 - 3" Bin Fronts	52 Openings 32 @ 7-1/2" x 9" 16 @ 9" x 9" 4 @ 12" x 12"	54 Openings 24 @ 7-1/2" x 6" 12 @ 9" x 6" 4 @ 7-1/2" x 12" 2 @ 9" x 12" 12 @ 12" x 12"	58 Openings 32 @ 6" x 6" 12 @ 12" x 9" 4 @ 7-1/2" x 9" 2 @ 9" x 9" 8 @ 12" x 12"	End Kit
						
Unit Depth	Unit Height	42 Openings 3" Bin Fronts Cat. No.	52 Openings Cat. No.	54 Openings Cat. No.	58 Openings Cat. No.	End Kit Cat. No.
12"	87"	1H6442	1H6452	1H6454	1H6458	1C1287
18"	87"	1H6542	1H6552	1H6554	1H6558	1C1887
24"	87"	1H6642	1H6652	1H6654	1H6658	1C2487



Ledge and Counter Units

Ledge Units

Ledge type shelving is recommended where greater depth of the lower compartment is desired, and a convenient working height surface ledge is required. Seven Heavy Duty Hi-Performance® shelves are included plus a heavy gauge ledge top with a reinforcing pan welded to the bottom for extra strength. This provides a total of seven openings.

The units are available in open or closed construction and may be equipped with standard shelving accessories, including locking doors at the top and bottom. Units are 36" wide, 12" deep at the top, and 24" deep at the bottom. Overall height is 87"; the ledge top is 39" high.

The End Kit includes 2 ledge top finishing strips to provide a finished appearance at the sides of the ledge top. Order one End Kit to finish each single unit, or row of units.

Counter Units

Penco steel counters present an extremely clean, classic appearance for over the counter or stock-room use. A smooth, extra heavy gauge reinforced counter top provides an excellent work surface. Three standard Heavy Duty Hi-Performance® Clipper shelves, adjustable on 1" centers, are used below. Units have box posts at all four corners and closed front bases.

The top is designed to butt against adjacent tops when more than one unit is used in a row for a continuous flush surface. One End Kit is required for each single unit, or to end a row of units. Two counter top finishing strips are included with each End Kit, to extend the top beyond the end and provide a finished appearance.

Counter Tops and Fronts may be purchased as separate components. Note that they may be used only when box posts are used at front and rear of unit.



Open Unit with End Kit



Closed Unit with End Kit

Front Bases are included with Closed Ledge Units.

Ledge Units				
Unit Width	Unit Depth	Unit Height	Unit Cat. No.	End Kit Cat. No.
Open Type Units				
36"	12" (Top) 24" (Bottom)	48" (Top) 39" (Bottom)	1H432L	19433E
Closed Type Units				
36"	12" (Top) 24" (Bottom)	48" (Top) 39" (Bottom)	1H434L	19435E



Front and rear views of 2 1H122C Basic Units plus 1 19125E End Kit

Counter Units				
Unit Width	Unit Depth	Unit Height	Unit Cat. No.	End Kit Cat. No.
Complete Units				
36"	24"	39"	1H122C	19125E
42"	24"	39"	1H123C	19125E
48"	24"	39"	1H124C	19125E
Counter Tops Only				
36"	24"	-	13670H	-
42"	24"	-	13680H	-
48"	24"	-	13690H	-
Counter Fronts Only				
36"	-	39"	13870H	-
42"	-	39"	13880H	-
48"	-	39"	13890H	-

Special Purpose Units

Artwork Shelving

This efficient unit serves the need for storing, organizing and protecting artwork. It is a basic piece of storage equipment wherever artwork is maintained. The unit has 18 openings, each with a 26-3/4" clear vertical opening. The unit includes closed back, sides and base, four Hi-Performance® shelves and 15 dividers. Dividers adjust easily on 1-1/2" centers. Can be accessorized with lockable doors. Order End Kit to finish each unit or row.

Shown in Light Putty (723) enamel.



Open Shelf Filing Record Storage

A space-saving efficient unit designed for filing a variety of records in a safe, organized, easily accessible system. Special tabbed dividers insert into the shelf and special back bracket for divider stability. They adjust easily on alternate 1" and 2" centers. The unit features closed sides and base. A special bracket at each shelf level is pierced to accept one tab of the divider. Order End Kit to finish a unit or a row.

Shown in Light Putty (723) enamel.



Artwork Shelving						
Unit Width	Unit Depth	Unit Height	No. of Shelves	No. of Dividers	Unit Cat. No.	End Kit Cat. No.
36"	24"	87"	4	15	1H6700	1C2487

Open Shelf Filing Record Storage						
Unit Width	Unit Depth	Unit Height	No. of Shelves	No. of Dividers	Unit Cat. No.	End Kit Cat. No.
36"	12"	87"	8	35	176709	1C1287

X-Ray Shelving

An efficient, practical storage unit with a broad application throughout the healthcare industry for the protective storage of X-ray. The unit features Heavy Duty Hi-Performance shelves, closed back, sides, and base. 25 dividers are furnished in two sizes which adjust easily on 1-1/2" centers. The dividers attach to the shelf with strong plastic buttons. Order End Kit to finish each unit or row.

Shown in Light Putty (723) enamel.

Refer to opening sizes in chart below.



Plan Shelving

Designed with the engineer, draftsman or architect in mind, this unit allows plans and drawings to be stored either rolled or flat. This unit provides 64 openings 6" x 36" x 6" for rolled storage and 9 openings 48" x 36" x 4" for flat storage. Unit includes Heavy Duty Hi-Performance shelves, closed back, sides and base. Can be accessorized with lockable doors. Order End Kit to finish each row.

Shown in Light Putty (723) enamel.



X-Ray Shelving						
Unit Width	Unit Depth	Unit Height	No. of Shelves	No. of Dividers	Unit Cat. No.	End Kit Cat. No.
36"	18"	87"	6	25	1H6705	1C1887

Plan Shelving						
Unit Width	Unit Depth	Unit Height	No. of Shelves	No. of Dividers	Unit Cat. No.	End Kit Cat. No.
48"	36"	87"	18	56	1H6659	1C3687

Divider Quantities			
Unit Depth	Divider Height	No. of Dividers	Clear Opening Height
18"	16"	15	14-13/16"
18"	18"	10	16-13/16"

Shelving Components

Box Posts

A high strength roll formed tubular box section usually used at unit fronts; permits full access to shelf width. Designed to be used in common between units, or at row ends. Permits vertical shelf adjustment on 1" centers using clips or nuts & bolts. Internal flange is punched on 3" centers to accept side sway bracing or closed side panels.

Offset Angle Posts

A roll formed high strength post which permits 1" vertical shelf adjustment using clips or nuts & bolts. Can be used at rear of units, or at front and rear. Offset recess adds rigidity and allows for independent shelf clip adjustment. Ends of flanges are punched on 3" centers to accept sway braces or closed panels.

Closed Upright Assemblies

Steel End or Intermediate Panels are used to close the sides of 87" tall shelving units and are securely welded to posts for rigidity.

Small Components

A & B. Clipper Clips - One piece 14 gauge compression clip for box and offset angle posts to hold shelf securely. A. For Hi-Performance Shelves; B. For Standard Flange Shelves.

C. Post Splice - Used to join Box or Angle posts for high-rise or multi-level shelving applications.

D. Floor Anchor Clip (Foot Plate) Punched for fastening posts to floor. Bolts to post.

E. Floor Protector - To distribute unit load and protect floor. For box and angle posts. Not for use on high-rise or multi-level shelving.

F. Anchors - For securing shelving posts to a concrete floor when Floor Anchor Clips are used. Use the longer anchor #9281 in seismic zones higher than 2A.

G. Heavy Duty Foot Plate - For box, single or double angle posts in high seismic areas.



Box Posts		
Unit Height	14 Gauge Cat. No.	16 Gauge Cat. No.
39"	1B4039C	-
48"	1B4048C	-
75"	1B4075C	-
87"	1B4087C	1B6087C
99"	1B4099C	-
123"	1B4123C	-
147"	1B4147C	-



Offset Angle Posts		
Unit Height	14 Gauge Cat. No.	16 Gauge Cat. No.
39"	1A4039C	-
48"	1A4048C	-
75"	1A4075C	-
87"	1A4087C	1A6087C
99"	1A4099C	-
123"	1A4123C	-
147"	1A4147C	-

14 Gauge Clipper Post Capacities (Pounds)

Unbraced Length (Max. Space Between Shelves)	Box Post Capacity	Single Angle Capacity	Double Angle Capacity (Bolted on 12" Centers)
9"	6740 lb	3760 lb	8270 lb
12"	6450 lb	3490 lb	7670 lb
15"	6070 lb	3130 lb	6880 lb
18"	5630 lb	2700 lb	5940 lb
21"	5090 lb	2180 lb	4790 lb
24"	4480 lb	1680 lb	4460 lb

Closed Upright Assemblies

Unit Depth	Unit Height	Cat. No.
Box Post		
1 Box Post, 1 Angle Post, 1 Side Panel		
12"	87"	15412CC
18"	87"	15418CC
24"	87"	15424CC
Offset Angle Post		
2 Offset Angles, 1 Side Panel		
12"	87"	15412AC
18"	87"	15418AC
24"	87"	15424AC
Box Post Intermediate		
1 Box Post, 2 Offset Posts, 1 Side Panel		
12"	87"	15412BC
18"	87"	15418BC
24"	87"	15424BC



Small Components

Letter	Unit Description	Cat. No.
A	Clipper Clip (Hi-Performance)	10002Z
B	Clipper Clip (Standard Flange)	100001Z
C	Post Splice	10030H
D	Floor Anchor Clip, 3-1/2" x 2-7/8"	10006Z
-	Shim for "D", 3-1/2" x 2-7/8", 11 Gauge	10011
E	Floor Protector, 1-3/4" x 2-5/8"	10007Z
F	Anchor, 3/8" x 2-1/4"	9280
	Anchor, 3/8" x 3-3/4"	9281
G	Foot Plate, Heavy Duty, 5-1/2" x 2-3/8", 7 Ga.	1ACX322H
-	Shim, Hvy. Duty for "G", 5-1/2" x 2-3/8", 7 Ga.	1ACX330

Shelving Components

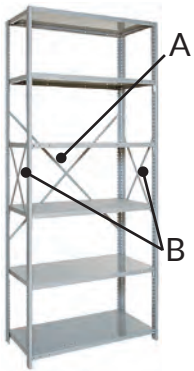

For Open Construction Sway Braces (A & B)

Sway braces provide stability for Open Type shelving. They are furnished in sets of two braces to fasten to one back or side of a unit. Hardware included.

Back sway braces (A.) eliminate lateral sway. They fasten to the flanges of offset angle posts used at the rear of units. Braces also bolt to each other at the center hole to ease installation.

Side sway braces (B.) eliminate front to back sway. They fasten to the flanges of the front and rear posts.



Sway Braces					
Letter Code	Description	Unit Width	Unit Depth	Overall Piece Length	Cat. No.
A	Back Sway Braces	24"	-	45"	12045A
		30"	-	50"	12050A
		36"	-	50-3/4"	12036H
		42"	-	57-1/8"	12042H
		48"	-	65-1/2"	12048H
B	Side Sway Braces	-	9"	11"	12011S
		-	12"	15"	12015S
		-	15"	19"	12019S
		-	18"	26"	12026S
		-	24"	34"	12034S
		-	30"	45"	12045S
		-	32"	46-1/4"	12046S
		-	36"	49"	12049S

Back and Side Panels									
Letter Code	Description	Shelf Width	Shelf Depth	39" Height	48" Height	51" Height	75" Height	87" Height	99" Height
C	Back Panels	24"	-	-	-	-	-	12340H	-
		30"	-	-	-	-	-	12440H	-
		36"	-	12500H	-	12510H	12530H	12540H	12550H
		42"	-	12600H	-	12610H	12630H	12640H	12650H
		48"	-	12700H	-	12710H	12730H	12740H	12750H
D	Side Panels	-	9"	-	-	-	-	11340H	-
		-	12"	11400H	11409H	11410H	11430H	11440H	11450H
		-	15"	-	-	-	-	11540H	-
		-	18"	11600H	11609H	11610H	11630H	11640H	11650H
		-	24"	11700H	-	11710H	11730H	11740H	11750H
		-	30"	11800H	-	-	-	11840H	11850H
		-	36"	11900H	-	-	11930H	11940H	11950H

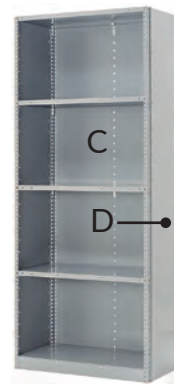

For Closed Construction Back and Side Panels (C & D)

Panels to enclose the backs and sides of Closed Type Shelving provide unit stability while giving greater protection to the shelving contents.

Back panels (C.) bolt to the flanges of offset angle posts at the rear of units. The center of the back is held tight against a shelf with a "back panel clip" furnished with each back. Common backs may be used when

units are placed back-to-back, provided that units are securely bolted together.

Backs 36" wide are furnished in one piece through 87" high. Over 87" high, they are split horizontally (2 pieces). 42" & 48" wide backs are furnished in one piece through 51" high; above 51" they are split horizontally (2 pieces). Hardware included.

Side panels (D.) fasten to the flanges in the front and rear posts. Furnished in one piece through 87" high. As an alternate to side panels, you may order Closed Upright Assemblies (shown on the previous page) which combine posts and side panels in one welded unit.



Hi-Performance® Shelves



Clipper Hi-Performance® Shelves maximize load handling capacity through a design which shapes the front and rear flanges into rigid tubular box beams. The box

shape provides two vertical surfaces in each box-flange that inherently give it a high strength-to-weight ratio. Additional reinforcing bars or angles are not used with Hi-Performance shelves. Reinforcing options for Class 3 shelves are shown at right.

The shelves are efficiently manufactured from high strength cold rolled steel on a modern automated roll forming mill.

For additional strength, front and rear flanges are welded to the underside of the shelf on 3" centers. Shelf corners are lapped and welded.

Shelves are available in a wide variety of sizes shown below in the capacity chart. All shelves are punched on 1.5" centers to accept shelving accessories such as dividers, label holders and bin fronts.

A. Class 3 Side Shelf Support (pairs)

Used to support Center Support in Class 3 applications.

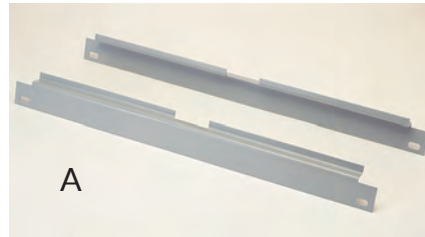

Class 3 Side Shelf Support	
Unit Depth	Cat. No.
18"	1H830H
24"	1H840H
30"	1H850H
36"	1H860H

B. Class 3 Center Support

Runs left to right beneath the mid-point of the shelf for conversion to Class 3. Supported by side shelf supports.

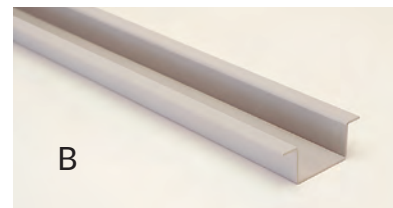

Class 3 Center Support	
Unit Width	Cat. No.
36"	H13736C
42"	H13742C
48"	H13748C

Clipper Hi-Performance® Shelf Capacities



Class 1
Heavy Duty
High Strength Steel



Class 2
Extra Heavy Duty
High Strength Steel



Class 3
Extra Heavy Duty
With Reinforcing*

Unit Width	Unit Depth	Cat. No.	Capacity	Cat. No.	Capacity	Capacity
36"	12"	1H203612C	800 lb	1H183612C	1100 lb	-
	15"	1H203615C	800 lb	1H183615C	1100 lb	-
	18"	1H203618C	850 lb	1H183618C	1200 lb	2000 lb
	24"	1H203624C	800 lb	1H183624C	1250 lb	2000 lb
	30"	1H203630C	500 lb	1H183630C	900 lb	2000 lb
	36"	1H203636C	500 lb	1H183636C	900 lb	2000 lb
42"	12"	1H204212C	600 lb	1H184212C	1100 lb	-
	15"	1H204215C	600 lb	1H184215C	1100 lb	-
	18"	1H204218C	600 lb	1H184218C	1050 lb	1600 lb
	24"	1H204224C	600 lb	1H184224C	900 lb	1600 lb
	30"	1H204230C	625 lb	1H184230C	1000 lb	1600 lb
	32"	1H204232C	525 lb	1H184232C	950 lb	1600 lb
48"	36"	1H204236C	475 lb	1H184236C	900 lb	1600 lb
	12"	1H204812C	500 lb	1H184812C	750 lb	-
	15"	1H204815C	500 lb	1H184815C	850 lb	-
	18"	1H204818C	500 lb	1H184818C	900 lb	1200 lb
	24"	1H204824C	500 lb	1H184824C	900 lb	1200 lb
	30"	1H204830C	500 lb	1H184830C	750 lb	1200 lb
	36"	1H204836C	500 lb	1H184836C	750 lb	1200 lb

* Class 3 Capacities are based upon the use of Extra Heavy Duty Shelves with (A) Side Shelf Supports and (B) Center Support for additional capacity. Must use nuts and bolts for shelves, not clips. All shelves are supplied with Clipper Clips. All shelf load capacities are in pounds for evenly distributed loads, and include a safety factor of 1.65.

Conventional Flange Shelves



Clipper Conventional Flange Shelves are fabricated from 18 gauge cold rolled steel. All sides of the shelf are double flanged for added strength. The corners are lapped and welded for positive reinforcement. Shelves secure to posts with Penco's unique compression Clipper clip, or can be bolted. Shelves are punched for divider placement on alternating 1" and 2" centers. Reinforcing options are shown at right.

All shelves are supplied with Clipper Clips. Nuts and bolts may be substituted upon request. All capacities are for safe static loads distributed uniformly over the entire shelf surface as determined by test. Refer all "Pass Thru" or other unusual conditions to Penco Engineering for their evaluation.

- Class 0 - For Normal Loads. No additional reinforcement.
- Class 1-B - For Normal Loads requiring impact resistance. A standard Class 0 Shelf with the addition of a 1" x 1/8" reinforcing bar in the front flange.
- Class 2-B - For Medium Loads. Same as Class 1-B with the addition of a reinforcing bar in the rear flange.
- Class 2-A - For Medium to Heavy Loads. A standard Class 0 shelf with the addition of field installed 1" x 1" x 1/8" reinforcing angles in front and rear flanges.

A. Reinforcing Bar

Roller steel bars insert in the shelf channel for reinforcement. Hardware is included. Not for use with Hi-Performance Shelves.

A - Reinforcing Bar			
Width	Depth	Height	Cat. No.
30"	1/8"	1-3/32"	16660H
36"	1/8"	1-3/32"	16670H
42"	1/8"	1-3/32"	16680H
48"	1/8"	1-3/32"	16690H

B. Reinforcing Angle

1/8" thick rolled steel angles added to the shelf flanges for developing class 2A shelves. Hardware is included. Not for use with Hi-Performance shelves.

B - Reinforcing Angle			
Width	Depth	Height	Cat. No.
36"	1"	1"	16520H
42"	1"	1"	16530H
48"	1"	1"	16690H

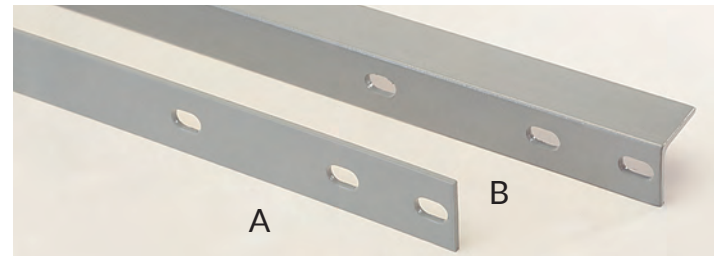

Clipper Conventional Flange Shelf Capacities - 18 Gauge

							
			Class 0	Class 1-B	Class 2-B	Class 2-A	
Unit Width	Unit Depth	Deflection @ Center Ft Edge	Cat. No.	Capacity	Capacity	Capacity	Capacity
24"	12"	.200"	12810C	990 lb		1270 lb	1580 lb
	18"	.200"	12830C	1110 lb		1430 lb	1430 lb
	24"	.200"	12840C	1140 lb		1090 lb	1090 lb
30"	12"	.250"	12910C	760 lb		980 lb	1230 lb
	18"	.250"	12930C	820 lb		1060 lb	1320 lb
	24"	.250"	12940C	920 lb		1030 lb	1030 lb
36"	9"	.300"	13000C	620 lb	NOTE: Class 1 shelves do not have any more load carrying capabilities over Class 0, but should be used where impact or concentrated loads occur along the front edge.	790 lb	980 lb
	12"	.300"	13010C	620 lb		810 lb	1010 lb
	15"	.300"	13020C	620 lb		820 lb	1020 lb
	18"	.300"	13030C	660 lb		850 lb	1050 lb
	24"	.300"	13040C	700 lb		920 lb	1090 lb
	30"	.300"	13050C	790 lb		860 lb	860 lb
	36"	.300"	13060C	740 lb		740 lb	740 lb
42"	12"	.350"	13110C	520 lb		690 lb	850 lb
	15"	.350"	13120C	520 lb		690 lb	860 lb
	18"	.350"	13130C	550 lb		710 lb	880 lb
	24"	.350"	13140C	580 lb		740 lb	930 lb
	30"	.350"	13150C	620 lb		800 lb	800 lb
48"	12"	.400"	13210C	450 lb		590 lb	740 lb
	18"	.400"	13230C	470 lb		600 lb	770 lb
	24"	.400"	13240C	480 lb		640 lb	790 lb
	30"	.400"	13250C	510 lb		670 lb	830 lb
	36"	.400"	13260C	550 lb		720 lb	720 lb

Shelving Accessories



Finished End Panels

Formed sheet steel panels used to finish the end of a shelving row. Panels attach to posts to cover holes and hardware. Presents an attractive and finished appearance. Must be used with Box Post at front, Angle Posts at rear.

Finished End Panels		
Unit Depth	Unit Height	Cat. No.
12"	87"	18241H
18"	87"	18440H
24"	87"	18540H

Sliding Doors

Flanged on all 4 sides and reinforced. Doors slide on quiet, smooth-running nylon rollers and guides. Designed for use with two 36" wide units side by side. Complete with grooved key cylinder lock and 2 keys. Hardware included. Not for use with Modular Drawers.



Sliding Doors			
Unit Width	Door Frame Height	Unit Height	Pair Cat. No.
72"	36"	39"	1H907236
72"	84"	87"	1H907284

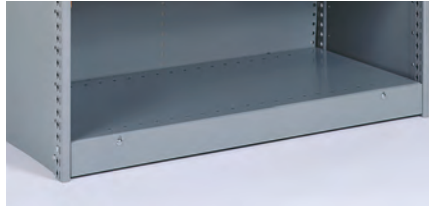

Front Base Strips

Closes the space between the floor and bottom shelf. Hardware included. The 4" high base is for use with the heavy duty foot plate.

Front Base Strip		
Unit Width	Unit Height	Cat. No.
24"	3"	14500H
30"	3"	14510H
36"	3"	14520H
36"	4"	14525H
42"	3"	14530H
48"	3"	14540H



Swinging Doors

3 Point latching with locking handle and 2 keys. Doors are pre-hung at the factory on a welded frame for easy assembly and good fit. Can be used on standard ledge or counter units up to 87" high. Order doors separately from units. Door can be attached to box posts

or angle posts. Base strips should be ordered to close the opening between the door frame and the floor.

NOTE: Not for use with Modular Drawers.

Swinging Doors			
Unit Width	Door Frame Height	Unit Height	Pair Cat. No.
For Below Ledge or Counter Height			
36"	36"	39"	19600H
For Above Ledge Unit			
36"	48"	48"	19610H
For Standard Shelving Units			
36"	73"	75"	19630H
36"	85"	87"	19640H
48"	36"	39"	19646H
48"	85"	87"	19650H



Sway Braces



Open shelving units, 87" high or shorter, must have at least one set of side sway braces per side and one set of back braces. Both side and back braces may be common with adjacent units. For multiple level, deck-over or high-rise shelving structures, the lowest set of braces should be within 4 1/2" of the floor. For posts over 87" high up to 123", order two sets of side and rear braces for each unit. Posts taller than 123" may require additional bracing.

For brace location requirements in regions where there is seismic activity, contact a local consultant or the Penco Product Management and Systems Engineering Department.

Shelving Accessories

A. - Bin Front

A formed steel panel partially enclosing the front opening of a shelf to keep bulk items within a bin. 1" & 2" Bin Fronts attach to the front of the shelf with bolts & nuts. 3" high Bin Front attaches to posts with metal clips. Hardware included.

B. - Sliding Divider

Formed to fit around front and rear flanges on the shelf. Position anywhere on surface. No hardware needed. For Hi-Performance Shelves.

C. - Partial Dividers

Partially subdivides shelf to separate stored items. Hardware included.

D. - Full Height Dividers

Used to divide a shelf opening into smaller units. Divider has a beaded front edge for strength and safety. Hardware included. NOTE: For Class 3 shelving applications, contact your representative regarding special notching of dividers.

E. - Label Holders

A formed steel strip that accepts 7/8" labels. Fastens to the shelf with plastic buttons (included).



F. - Flue Spacer

A component that can provide a 6" open area between rows of back-to-back shelving to facilitate installation of fire suppression equipment (hardware included).

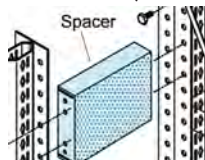

A. - F. Accessories					
Letter Code	Unit Desc.	Unit Width	Unit Depth	Unit Height	Cat. No.
A	Bin Front	36"	-	1"	14210H
		36"	-	2"	14220H
		36"	-	3"	14230C
		42"	-	3"	14330C
		48"	-	3"	14430C
B	Sliding Divider	-	12"	4"	1H4124C
		-	12"	6"	1H4126C
		-	18"	4"	1H4184C
		-	18"	6"	1H4186C
		-	24"	4"	1H4244C
C	Partial Dividers	-	12"	2"	16395H
		-	12"	4"	16410H
		-	18"	2"	16397H
		-	18"	4"	16430H
		-	24"	4"	16440H
D	Full Height Dividers	-	12"	6"	15600H
		-	12"	9"	15620H
		-	12"	12"	15640H
		-	12"	14"	15650H
		-	12"	18"	15670H
		-	15"	6"	15700H
		-	15"	12"	15740H
		-	18"	6"	15800H
		-	18"	9"	15820H
		-	18"	10"	15830H
		-	18"	12"	15840H
		-	18"	16"	15860H
		-	18"	18"	15870H
		-	18"	24"	15890H
		-	24"	6"	15900H
		-	24"	9"	15920H
		-	24"	12"	15940H
		-	24"	18"	15970H
		-	24"	24"	15990H
-	36"	18"	16170H		
E	Label Holders	24"	-	-	13900H
		30"	-	-	13910H
		36"	-	-	13920H
		42"	-	-	13930H
		48"	-	-	13940H
F	Flue Spacer	-	6"	4"	1ACX522H

QuickShip Shelving

Basic Clipper Shelving OPEN QuickShip Units - 87" High



Unit Width	Shelf Depth	5 Shelf Cat. No.	6 Shelf Cat. No.	7 Shelf Cat. No.	8 Shelf Cat. No.
36"	12"	1H7015028	1H7016028	1H7017028	1H7018028
	18"	1H7025028	1H7026028	1H7027028	1H7028028
	24"	1H7035028	1H7036028	1H7037028	1H7038028
48"	12"	1H7075028	1H7076028	1H7077028	1H7078028
	18"	1H7085028	1H7086028	1H7087028	1H7088028
	24"	1H7095028	1H7096028	1H7097028	1H7098028

Pictured at left: a 5-shelf Open Basic Unit. It requires an Open End Kit for completion (see below).









Basic Clipper Shelving CLOSED QuickShip Units - 87" High

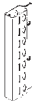
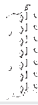

Unit Width	Shelf Depth	5 Shelf Cat. No.	6 Shelf Cat. No.	7 Shelf Cat. No.	8 Shelf Cat. No.
36"	12"	1H8015028	1H8016028	1H8017028	1H8018028
	18"	1H8025028	1H8026028	1H8027028	1H8028028
	24"	1H8035028	1H8036028	1H8037028	1H8038028
48"	12"	1H8075028	1H8076028	1H8077028	1H8078028
	18"	1H8085028	1H8086028	1H8087028	1H8088028
	24"	1H8095028	1H8096028	1H8097028	1H8098028

Pictured at left: a 5-shelf Closed Basic Unit. It requires a Closed End Kit for completion (see below).

Clipper QuickShip Components

Description	W	D	H	Cat. No.
 Box Post	-	-	87"	1B4087028
 Offset Angle Post	-	-	87"	1A4087028
 Floor Anchor Clip	3-1/2"	2-7/8"	-	10006Z
 Concrete Floor Anchor	3/8"	-	2-1/4"	9280
 Back Sway Braces	36"	-	-	12036H028
	48"	-	-	12048H028
 Side Sway Braces	-	12"	-	12015S028
	-	18"	-	12026S028
	-	24"	-	12034S028
 Back Panels	36"	-	87"	12540H028
	48"	-	87"	12740H028
 Side Panels	-	12"	87"	11440H028
	-	18"	87"	11640H028
	-	24"	87"	11740H028
 Front Base Strips	36"	-	3"	14520H028
	48"	-	3"	14540H028

Clipper Shelving QuickShip End Kits - 87" High

Unit Depth	For OPEN Units Cat. No.	For CLOSED Units Cat. No.
12"	101287028	1C1287028
18"	101887028	1C1887028
24"	102487028	1C2487028

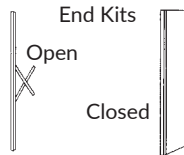

Clipper® QuickShip Adjustable Shelving

- High Quality Industrial Grade
- Open and Closed Configurations
- 87" high units with Box & Angle Posts
- Shelves adjust on 1" vertical centers
- Heavy duty box beam shelves - 4 sizes
- Attractive 028 Gray powder coat finish
- Accessories - Front Bases, Anchors and Floor Anchor Clips

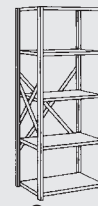

Open Basic Unit

Use an OPEN Clipper Basic Unit to start a single unit or a row of shelving. Add additional Clipper Basic Units to add to the row. To end a row or single unit, finish the unit with an OPEN End Kit.



Open End Kit

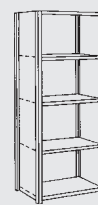

Closed Basic Unit

Use a CLOSED Clipper Basic Unit to start a single unit or a row of closed shelving. Add additional Closed Clipper Basic Units to add to the row. To end a row or single unit, finish the unit with a CLOSED End Kit.



Closed End Kit

Heavy Duty Shelves & Capacities

(Each Shelf comes with 4 Clipper Clips)

Size	Cat. No.	Capacity
36" W x 12" D	1H203612028	800 lbs.*
36" W x 18" D	1H203618028	850 lbs.*
36" W x 24" D	1H203624028	800 lbs.*
48" W x 12" D	1H204812028	500 lbs.*
48" W x 18" D	1H204818028	500 lbs.*
48" W x 24" D	1H204824028	500 lbs.*



* Evenly Distributed Loads for Clipper Hi-Performance Heavy Duty Class 1 Shelves.

Specifications

General: All shelving shall comply with SMA and ANSI MH 28.1-1982 and in addition shall have the following characteristics:

Posts: All posts shall be punched for clip or nut and bolt construction. Shelves and accessories are to be vertically adjustable on 1" centers. Side sway braces or side panels to be attached to the side flange of the post. Bolts, nuts, and sway braces or panels shall not obstruct the full adjustability of the shelves.

Box Post: Box post to be roll formed and have overall dimensions of 3/4" wide x 2-7/16" deep. Box post to be flush within 1/4" of the face of the shelves when assembled.

Offset Angle: Offset angle post shall be roll formed and have overall dimensions of 1-1/8" wide x 2-1/2" deep. The rear flange shall be punched to accept sway braces or backs, the side flange shall be punched to accept side sway braces or side panels.

Side Panels: Shall be 24 gauge steel. Each side shall be punched with holes for bolting to posts.

Backs: Shall be 24 gauge steel with holes on each side for bolting to angle posts and in the middle for using a back panel clip.

Sway Braces: To be 12 gauge x 3/4" steel punched at each end for bolting to posts and at the center for strength and ease of assembly.

Clipper Shelf Clip: One piece 14 gauge rugged compression type to insert into either box or offset angle posts to form a positive four point connection. Clips shall have two claw-like hooks to seat firmly into post slots and two tabs at bottom to seat into post holes for a tight friction connection. All clips for all posts and shelves to be the same. Design shall offer a pre-clipping feature to simplify erection. Finish: zinc plated. All shelves are to have four independently adjustable clips.

Shelves: Conventional Flange, Class "O": Shall be 18 gauge steel with a 1-3/16" vertical face on all four sides, front and rear faces to have 17/32" return flange 90° with the edges coined upward to prevent snagging. Sides to have a 5/8" return flange 90°. All four shelf corners shall be closed by lapping and spot welding together to provide a firm, rigid shelf. Shelf shall be universally punched for use with all available accessories and for clip or bolted assembly. Shelves are available in 24", 30", 36", 42" and 48" widths and 9", 12", 15", 18", 24", 30" and 36" depths. Shelves can be reinforced by adding 1-3/32" x 11 ga. bars or 1" x 1" x 1/8" angles to front and back flanges.

Shelves: Clipper Hi-Performance® Box Formed: Medium Duty, Heavy Duty and Extra Heavy Duty are manufactured from cold rolled steel in three material thicknesses that provide up to three different shelf capacities per size. Shelves have 1-1/4" face on all four sides. Front and rear faces have four 90° bends providing a 3/4" x 1-1/4" high tubular shape with an 11/16" wide flange seated against the underside of the shelf. The flange is spot welded to the underside of the shelf on 3" centers. Sides have a 5/8" return flange 90°. All four corners are closed by lapping and spot welding together. Medium Duty and Heavy Duty shelf tabs for lapping and welding have formed ribs to maintain the same snug fit in the shelf clip as the extra heavy duty shelf. Overall, the shelf depth and width is 1/4" less than nominal. The shelf is punched for divider adjustment on 1-1/2" centers and for attachment of label holders, bin fronts and base fronts. Hi-Performance shelves are available in 36", 42", & 48" widths and 12", 15", 18", 24", 30" & 36" depths.

Extra Heavy Duty Reinforced (Class 3) Hi-Performance Shelves provide maximum capacity using Extra Heavy Duty shelves that are reinforced

using 13 gauge side shelf supports bolted to the Clipper posts and 14 gauge 1-5/32" high hat shaped center supports held in place by a notch and flange in the side shelf support.

Ledge Tops: To be 14 gauge steel. Face of ledge to be 1-1/8" and have a center reinforcing pan. Ledge top to project 1-1/8" beyond the face of the post and to have two 14 gauge angles welded to underside for strength and bolting to post. Must be used with box posts below ledge.

Ledge Tops: To be manufactured from 14 gauge steel and furnished to give ledge top a finished appearance.

Counter Tops: To be 14 gauge steel. Face of counter top to be 1-1/8" and project 1-1/8" beyond face of post with a welded center reinforcing pan. Units to be furnished with box post front and rear for finished appearance. 14 gauge counter top ends can be furnished at the ends of all rows for a finished appearance.

Counter Front: To be 18 gauge steel attached with no exposed fasteners.

Base Strip: Shall be 18 gauge steel attached to face of shelf with bolts and nuts to close space between the bottom of the shelf and the floor.

Label Holder: Shall be 24 gauge steel with necessary holes for attaching to shelves with plastic push-in fasteners.

Shelf Dividers: 6" high through 20" high shall be 24 gauge, 24" high and over shall be 20 gauge. All divider front flanges shall have a 5/16" diameter bead. Top, bottom and rear flanges are 7/8". Dividers less than 24" high shall be attached with plastic push-in fasteners, 24" and higher are bolted.

Partial Dividers: Shall be 18 gauge steel with a 7/8" flange at the bottom. Attached with push-in Plastic Button fasteners.

Sliding Divider: To be 20 gauge steel manufactured to give infinite lateral adjustability. Divider portion shall be sloped 45° at front, 1/2" radius at front corner.

Bin Fronts: To be 18 gauge steel. One and two inch high bin fronts shall be bolted to the face of the shelf. Three inch high bin fronts to be attached to the post by use of 16 gauge zinc plated channel clips.

Swinging Doors: Consist of a 16 gauge steel frame and 20 gauge doors, reinforced to prevent warping. Doors are riveted to three 5-knuckle hinges and have a three-point latching device with chrome plated key lock handle. Doors to be preassembled in the frame at factory.

Sliding Doors: Set of doors is 72" wide and cover two 36" wide units. Each door shall be 22 gauge with two or more 18 gauge reinforcing pans, recessed handle and nylon glides and rollers. Each set has 16 gauge channels welded at the top and bottom, and 20 gauge channels on the ends. Doors shall be contained in top, bottom and vertical channels. Right hand door has a provision for a cylinder lock.

Foot Plates: Shall be 13 gauge zinc plated steel and be used to protect floors.

Finish: Finish to be selected from manufacturer's standard colors. Surface to be pretreated with a multiple stage cleaning and metal preparation process. Finish coat of high grade pure polyester powder coat is applied and properly cured to paint manufacturer specifications to achieve optimum performance.

Clipper® and Hi-Performance® are registered trademarks of Penco Products, Inc. Penco reserves the right to vary specifications consistent with a policy of continuous product improvement.

Introduction

For HIGH, WIDE or BULKY Hand-Loaded Items

Penco Wide Span is the standard of the industry for shelving designed to contain wide, bulky loads. It bridges the storage gap between conventional shelving and pallet rack. The range of applications can be from a single unit (right) to a sophisticated multi-level picking system (bottom).

Penco Wide Span is easily the quickest shelving product to assemble. There are a minimum number of parts that snap or fit into place quickly and easily. No bracing to add and no hardware required. Not to be loaded with fork trucks.



Multi-level Wide Span Pick Module



Optional wire deck shelves

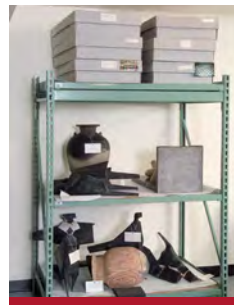

Museum storage



Auto part center storage

How To Order Wide Span Units

Wide Span Units are easy to order. Shown on the next page are common sizes of units for 3 levels of plywood shelves.

Many other sizes are available by ordering from the component parts on the following pages. Allow for the width of each upright post in planning your layout. The Wide Span Growth Chart on the next page illustrates this concept for your convenience.

To order Wide Span Shelving Units:

1. Order as many Basic Units as you need for your row of shelving.
2. Order one Rack Ending Kit to end each row or single unit (plywood must be purchased separately).

Growth Dimension Considerations

When planning a row of Wide Span Shelving, allow for the 1-3/4" width of each upright post and 1/4" additional per bay for the thickness of the beam ends. The Wide Span Growth Chart on the following page shows typical growth for two 96" steel shelf units and 96-1/2" plywood beam units.

For safety purposes, we recommend that Wide Span Uprights be floor or wall anchored.

Wide Span Units

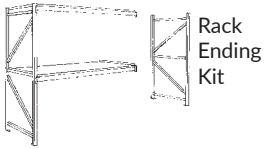

Basic 2-Shelf Unit

- 1 Upright Frame
- 2 Steel Shelf Levels
- 2 Pair Side Shelf Supports
- 2 Pair Rigidity Beams

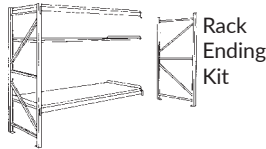

Basic 3-Shelf Unit

- 1 Upright Frame
- 3 Steel Shelf Levels
- 3 Pair Side Shelf Supports
- 2 Pair Rigidity Beams

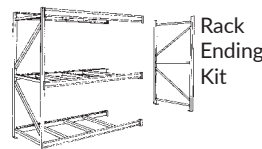

Basic 3-Level Unit for Plywood *

- 1 Upright Frame
- 3 Pair Standard Plywood Beams
- 3 Plywood Support Angles per pair of 72-1/2" Beams
- 4 Plywood Support Angles per pair of 96-1/2" Beams

ORDER RACK END KITS SEPARATELY. SEE BELOW.

* NOTE: Plywood not included.

Plywood used in lieu of Steel Shelves

Special beams and supports are used when plywood, pressed wood, particle board, oriented strand board or other composition type panels are used in place of steel shelves (these deck materials must be purchased separately).



All Wide Span Beams have a patented Beam Lock that secures the beam end to the upright post to retard accidental beam dislodging. An embossed nib on the beam end engages a slot on the side on the upright post, which

holds the beam end tight against the post (U. S. Patent No. 4,928,834).

Can be disengaged with a mallet.

Two beam types are available: Standard Plywood Beams, and Heavy Duty Plywood Beams. Each is manufactured an extra 1/2" long to facilitate placement of full foot lengths of decking. Each uses a different type of front to back support for the decking material. Neither can be used in the same unit or bay with standard rigidity beams, because the lengths are different.

Standard Plywood Beams

Standard Size panels may be used without trimming. This is accomplished by the step design which allows decking depths which match the upright depth. Capacities vary by beam length. Plywood Support Angles must be ordered separately. A full 48" x 96" deck will fit on a pair of 96-1/2" beams when 50" deep upright frames are used.

Heavy Duty Plywood Beams

These beams can support a greater load than Standard Plywood Beams, and have a flush front facing the aisle. Requires the use of Beam Brace/Heavy Duty Plywood Supports which are ordered separately.

Wide Span Shelving Units

Unit Height	Beam Width	30" Deep		36" Deep		48" Deep	
		Basic Unit Cat. No.	Rack End Kit Cat. No.	Basic Unit Cat. No.	Rack End Kit Cat. No.	Basic Unit Cat. No.	Rack End Kit Cat. No.
Two Shelf Units with Steel Shelves							
72"	60"	20351	20002C	20359	20003C	20375	20005C
	72"	20353	20002C	20361	20003C	20377	20005C
	84"	20355	20002C	20363	20003C	20379	20005C
	96"	20357	20002C	20365	20003C	20381	20005C
96"	60"	20383	20018C	20391	20019C	20407	20021C
	72"	20385	20018C	20393	20019C	20409	20021C
	84"	20387	20018C	20395	20019C	20411	20021C
	96"	20389	20018C	20397	20019C	20413	20021C
Three Shelf Units with Steel Shelves							
120"	60"	20415	20034C	20423	20035C	20439	20037C
	72"	20417	20034C	20425	20035C	20441	20037C
	84"	20419	20034C	20427	20035C	20443	20037C
	96"	20421	20034C	20429	20035C	20445	20037C
144"	60"	20447	20050C	20455	20051C	20471	20021C
	72"	20449	20050C	20457	20051C	20473	20021C
	84"	20451	20050C	20459	20051C	20475	20021C
	96"	20453	20050C	20461	20051C	20477	20021C
Three Level Units for Plywood Shelves							
120"	72-1/2"	-	-	-	-	20512	20037C
	96-1/2"	-	-	-	-	20514	20037C
144"	72-1/2"	-	-	-	-	20535	20053C
	96-1/2"	-	-	-	-	20537	20053C

Wide Span Growth Diagram

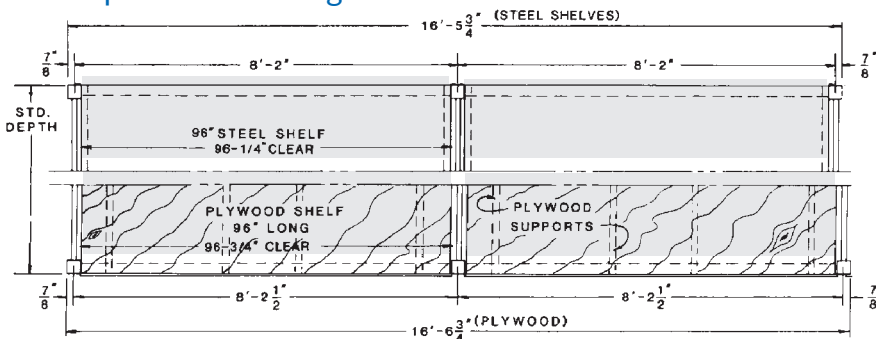

Shelving Components

Side Shelf Supports

Heavy gauge steel angles which support steel shelves. Each support engages the upright frame at four points. One or more tangs stamped into the surface engages the reinforcing pan on the shelf bottom to prevent accidental dislodging of the shelf. One pair is required for each steel shelf.



Side Shelf Supports

Unit Depth	Capacity Per Pair	Cat. No. Per Pair
24"	3600 lb	22024
30"	2900 lb	22030
36"	2400 lb	22036
42"	2100 lb	22042
48"	1800 lb	22048

Rigid Wall Spacers

Assures that uniform spacing between upright and building wall is maintained. Includes hardware to fasten to frame.

Rigid Wall Spacers

Unit Depth	Cat. No.
4"	5AR404
6"	5AR406
8"	5AR408
10"	5AR410

Rigid Row Spacers

Used to space and join back-to-back units. Adds rigidity to double row applications. Includes hardware.

Rigid Row Spacers

Unit Depth	Cat. No.
6"	5AR506
8"	5AR508
10"	5AR510
12"	5AR512

Standard Plywood Beams



Designed to support 1/2" thick deck material flush with top of beam flange when used with the appropriate number of Plywood Support Angles

which insert into slots in beam step. Overall height is 3-1/2". Beam step is 1-1/2" deep by 5/8" high. A 48" deep deck will fit between beams without trimming when a 48" deep upright frame is used.

Standard Plywood Beams

Beam Width	Capacity Per Pair***	Cat. No. Per Pair
48-1/2"	2500 lb	20337
60-1/2"	2120 lb	20338
72-1/2"	1700 lb	20339
84-1/2"	1500 lb	20340
96-1/2"	1350 lb	20335

***Capacity in pounds for evenly distributed loads.

Heavy Duty Plywood Beams



A heavy duty beam designed for greater capacity when used with deck material. Deck material sits on beam step and is supported by the appropriate number of Beam Brace/

Heavy Duty Plywood Supports (order separately). Deck must be trimmed to 2" less depth than the depth of the upright frame.

Heavy Duty Plywood Beams can be used in the same unit or bay with Standard Plywood Beams. However, the decking material must be trimmed 2" for the heavy duty beams. Capacity in pounds for evenly distributed loads.

Heavy Duty Plywood Beams

Beam Width	Capacity Per Pair	Cat. No. Per Pair
48-1/2"	2500 lb	210480
72-1/2"	2500 lb	210720
96-1/2"	2500 lb	210960

Standard Plywood Support Angles

Std Plywood Support Angles

Depth	Cat. No.
24"	20341C
30"	20330C
36"	20342C
42"	20332C
48"	20336C

Standard Plywood Support Angles fit into the slots in the beam step of Standard Plywood Beams. Order separately from beams. Order 2 per pair of 48-1/2" & 60-1/2" beams; 3 for 72-1/2" & 84-1/2" beams; 4 for 96-1/2" beams.

Beam Brace / H. D. Plywood Support

This item fits easily into the inside of the beam opening and has two functions.

Beam Brace / H.D. Support

Depth	Capacity	Cat. No.
24"	1200 lb	202040C
30"	1100 lb	202050C
36"	900 lb	202060C
42"	700 lb	202070C
48"	500 lb	202080C
50"	500 lb	2P0050C

When Rigidity Beams are used as load bearing members, the Beam Braces are used to keep the beams from twisting.

When used with Heavy Duty Plywood Beams they are become

Plywood supports. Use a minimum of two supports per pair of beams. Use more if required by your load condition - see capacities in the table.

Wide Span Base Closures

These base closures will close the space beneath a unit between the bottom Rigidity or Heavy Duty Plywood Beam at their lowest position, and the floor, or at the end of the unit between the lowest horizontal brace and the floor. They are supplied with tek screws for fastening.

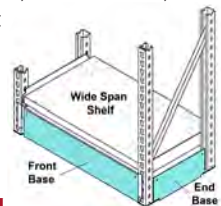

Wide Span End Bases

Depth	Height	Cat. No.
18"	7-3/4"	202210H
24"	7-3/4"	202211H
30"	7-3/4"	202212H
36"	7-3/4"	202213H
42"	7-3/4"	202214H
48"	7-3/4"	202215H
50"	7-3/4"	202216H

Wide Span Front Bases

Width	Height	Cat. No.
48"	6"	202200H
60"	6"	202201H
72"	6"	202202H
84"	6"	202203H
96"	6"	202204H

Shelving Components

Upright Frames



Penco Wide Span Upright Frames are made from heavy gauge steel, MIG welded into one rigid assembly containing posts, diagonal and horizontal braces and foot plates for anchoring. There is no assembly required. Other sizes are available. See page 12 for anchors.

Posts are punched on the face to provide positive independent beam placement on 2" vertical centers. The posts are marked on 12" centers to facilitate placement of shelf levels. A slot on each side of the post accepts a nib on the end of each beam, to lock it in place.

Frames have a capacity of 7,500 pounds with a 1.92 safety factor where vertical beam spacing does not exceed 60". Footplates are punched for anchoring: see "Anchors" in the post section of Clipper shelving on page 12.

Upright Frames							
Unit Height	18" Deep Cat. No.	24" Deep Cat. No.	30" Deep Cat. No.	36" Deep Cat. No.	42" Deep Cat. No.	48" Deep Cat. No.	50" Deep Cat. No.*
72"	20000C	20001C	20002C	20003C	20004C	20005C	2P072C
84"	20008C	20009C	20010C	20011C	20012C	20013C	2P084C
96"	20016C	20017C	20018C	20019C	20020C	20021C	2P096C
120"	20032C	20033C	20034C	20035C	20036C	20037C	2P020C
144"	20048C	20049C	20050C	20051C	20052C	20053C	2P044C
168"	-	20065C	20066C	20067C	20068C	20069C	2P068C
192"	-	24001C	24002C	24003C	24004C	24005C	2P092C

* 50" deep frame is for use with H.D. Plywood Beam. Allows use of standard 48" plywood deck without cutting for depth dimension.



Rigidity Beams

Rigidity beams provide lateral stability when steel shelves are used. A minimum of 2 pairs of beams is required per unit. They are constructed of 3" high steel channels with return flanges, with a beam end connector welded to each end.

It is not necessary to place rigidity beams beneath each steel shelf. Rigidity Beams do not carry a load unless used to support wire decking. If used with wire decking, then use the Beam Brace/Heavy Duty Plywood Supports (shown on the previous page).

Rigidity Beams		
Unit Width	Capacity Per Pair**	Cat. No. Per Pair
48"	2500 lb	20315
60"	2140 lb	20316
72"	1780 lb	20317
84"	1580 lb	20318
96"	1340 lb	20319

** Capacity per pair in pounds for evenly distributed load when used as load bearing members using Beam Braces/H.D. Plywood Supports as follows: 60" x 72" length, 1 Beam Brace; 84" x 96" length, 2 Beam Braces.

Steel Shelves

Penco Steel Wide Span Shelves are the ultimate in providing a smooth, safe surface for storing a wide variety of items. They are 1-3/4" high and feature double flanges at front and rear edges with a full width reinforcing pan welded to the center of the bottom.

Each shelf requires a pair of Side Shelf Supports, which must be ordered separately. For 36", 42" and 48" depths, the appropriate number of 18" and 24" deep shelves are provided, and are installed together on the Side Shelf Supports to achieve the stated depth.

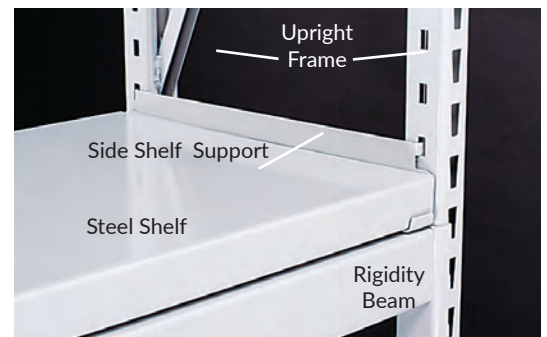

Tire Rack Beams

Penco can supply special beams for installation on the aisle side that are slanted to accept passenger tires, while standard Rigidity Beams are used at the rear. Contact your Penco representative for more information on Tire Rack Units.

Steel Shelves										
Unit Depth	48" Wide		60" Wide		72" Wide		84" Wide		96" Wide	
	Cat. No.	Capacity *	Cat. No.	Capacity *	Cat. No.	Capacity *	Cat. No.	Capacity *	Cat. No.	Capacity *
18"	22418C	1200 lb	22518C	1200 lb	22618C	1000 lb	22718C	800 lb	22818C	600 lb
24"	22424C	1500 lb	22524C	1200 lb	22624C	1000 lb	22724C	800 lb	22824C	600 lb
30"	22430C	2300 lb	22530C	1800 lb	22630C	1500 lb	22730C	1200 lb	22830C	900 lb
36"	22436C	2400 lb	22536C	2400 lb	22636CC	2000 lb	22736C	1600 lb	22836C	1200 lb
42"	22442C	2000 lb	22542C	2000 lb	22642C	2000 lb	22742C	1600 lb	22842C	1200 lb
48"	22448C	1800 lb	22548C	1800 lb	22648C	1800 lb	22748C	1600 lb	22848C	1200 lb

* NOTE: Shelf capacities in pounds, evenly distributed.

Specifications

COMPONENTS

Upright Frames: Penco Wide Span Upright Frames are made from heavy gauge steel, MIG welded into one rigid assembly containing posts, diagonal and horizontal braces and foot plates. There is no assembly required. Many sizes are available. Posts are punched on the face to provide positive independent beam placement on 2" vertical centers. The posts are marked on 12" centers to facilitate placement of shelf levels. A slot on each side of the post accepts a nib on the end of each beam, to lock it in place. Frames have a capacity of 7,500 pounds with a 1.92 safety factor where vertical beam spacing does not exceed 60".

Rigidity Beams: Rigidity beams provide lateral stability for the shelving; a minimum of two pairs of beams is required per unit. They are constructed of 3" high steel channels with return flanges and a beam end connector welded to each end. Beams are supplied in even foot lengths from 4' through 8'. Clearance between upright frames is 1/4" more than stated beam size. If the beams are being used as load bearing members, then Beam Braces are required. All Wide Span Beams have a patented Beam Lock that secures the beam end to the upright post to retard accidental beam dislodging. An embossed nib on the beam end engages a slot on the side on the upright post, which holds the beam end tight against the post (U. S. Patent No. 4,928,834). Can be disengaged with a mallet. It is normally not necessary to place rigidity beams beneath each steel shelf.

Steel Shelves: Penco Steel Wide Span Shelves are the ultimate in providing a smooth, safe surface for storing a wide variety of items. They are 1-3/4" high and feature double flanges at front and rear edges with a full width reinforcing pan welded to the center of the bottom. Each shelf requires a pair of Side Shelf Supports, which must be ordered separately. For 36", 42" and 48" depths, the appropriate number of 18" and 24" deep shelves are provided, and are installed together on the Side Shelf Supports to achieve the stated depth.

Side Shelf Supports: Heavy gauge steel angles which support steel shelves. Each support engages the upright frame at four points. One or more tangs stamped into the surface engages the reinforcing pan on the shelf bottom to prevent accidental dislodging of the shelf. One pair is required for each steel shelf.

Rigid Wall Brackets: Used to fasten upright frames to the wall for sturdy single row applications. Includes hardware to fasten to frame.

Rigid Row Spacers: Used to space and join back-to-back shelving units. Adds rigidity to double row applications. Includes hardware.

PLYWOOD USED IN LIEU OF STEEL SHELVES: Special beams and supports are used when plywood, pressed wood, particle board, oriented strand board or other composition type panels are used in place of steel shelves (these deck materials must be purchased separately). Two beam types are available: Standard Plywood Beams, and Heavy Duty Plywood Beams. Each is manufactured an extra 1/2" long to facilitate placement of full foot lengths of decking. Each uses a different type of front to back support for the decking material. Neither can be used in the same unit or bay with standard rigidity beams, because the lengths are different.

Standard Plywood Beams: Designed to support 1/2" thick deck material flush with top of beam flange when used with the appropriate number of Plywood Support Angles (ordered separately) which insert into slots in beam step. Overall height is 3-1/2". Beam step is 1-1/2" deep by 5/8" high. A 48" deep deck will fit between beams without trimming when a 48" deep upright frame is used.

Heavy Duty Plywood Beams: These beams can support a greater load than Standard Plywood Beams, and have a flush front facing the aisle. Requires the use of Beam Brace/Heavy Duty Plywood Supports which are ordered separately. A full 48" x 96" deck will fit on a pair of 96-1/2" beams when 50" deep upright frames are used. Heavy Duty Plywood Beams can be used in the same unit or bay with Standard Plywood Beams, however the depth of the decking material must be trimmed for the heavy duty beams (i.e. deck must be trimmed to 2" less depth than the depth of the upright frame.)

Standard Plywood Support Angles: Standard Plywood Support Angles fit into the slots in the beam step of Standard Plywood Beams. Order separately from beams. Order two per pair of 48-1/2" & 60-1/2" beams; three for 72-1/2" & 84-1/2" beams; four for 96-1/2" beams.

Beam Brace/Heavy Duty Plywood Support: This item fits easily into the inside of the beam opening and has two functions: A) When Rigidity Beams are used as load bearing members, the Beam Braces are used to keep the beams from twisting; B) When used with Heavy Duty Plywood Beams they are used as Plywood supports. Use a minimum of two supports per pair of beams. Use more if required by your load condition.

PENCO RESERVES THE RIGHT TO VARY SPECIFICATIONS CONSISTENT WITH A POLICY OF CONTINUOUS PRODUCT IMPROVEMENT.

RivetRite Introduction

RivetRite Universal Shelf Framing System

We call RivetRite the Universal Shelf Framing System because so many storage requirements can be met with only a few simple components. RivetRite is engineered to provide safe, economical storage of virtually any type of hand-loaded material. Structural integrity is ensured by a rigid boltless connection between beams and posts.

RivetRite offers the following to help solve your storage problems:

- Economical – your shelving dollar goes a long way
- Easy assembly without special tools - all you need is a rubber mallet to assemble most units
- Access to contents from all four sides - no braces to get in the way
- Shelves adjustable on 1-1/2" centers- allows you to custom design unit to fit your load size
- A variety of beams to accommodate a wide range of loads - you buy the capacity you need
- Finished in durable powder coat enamel - baked on for permanence. Available in 24 colors
- Order by pre-configured UNITS or by individual components



Components

RivetRite shelving is comprised of 4 types of posts for the vertical members and various horizontal support members. In this way it is possible to order by components to tailor the shelving to the items to be stored.

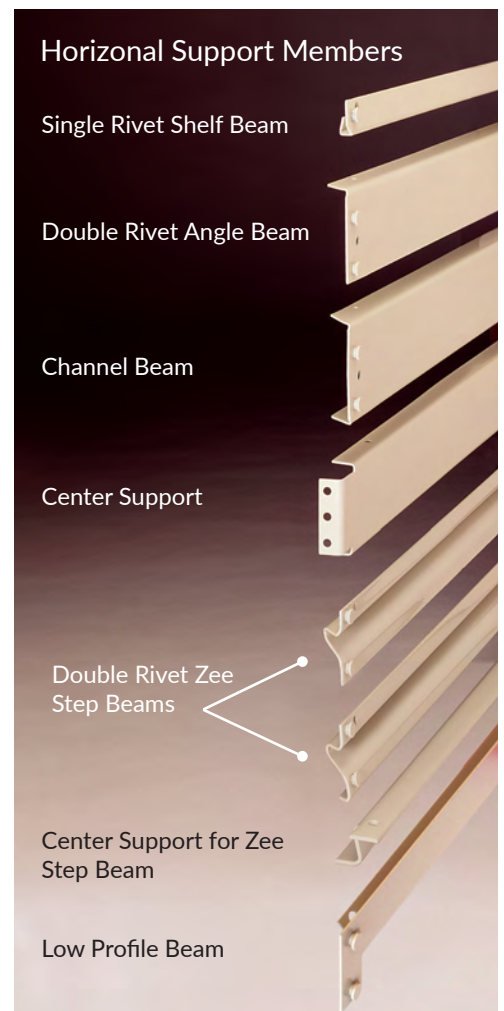

(Double Rivet Beams are ALWAYS used for the full perimeter at the TOP and BOTTOM of ALL

Building Your RivetRite® Units

Single Rivet High Density Units

Single Rivet high density shelving uses single rivet beams on intermediate levels, and double rivet beams at the top and bottom for rigidity. For units up to 48" wide.

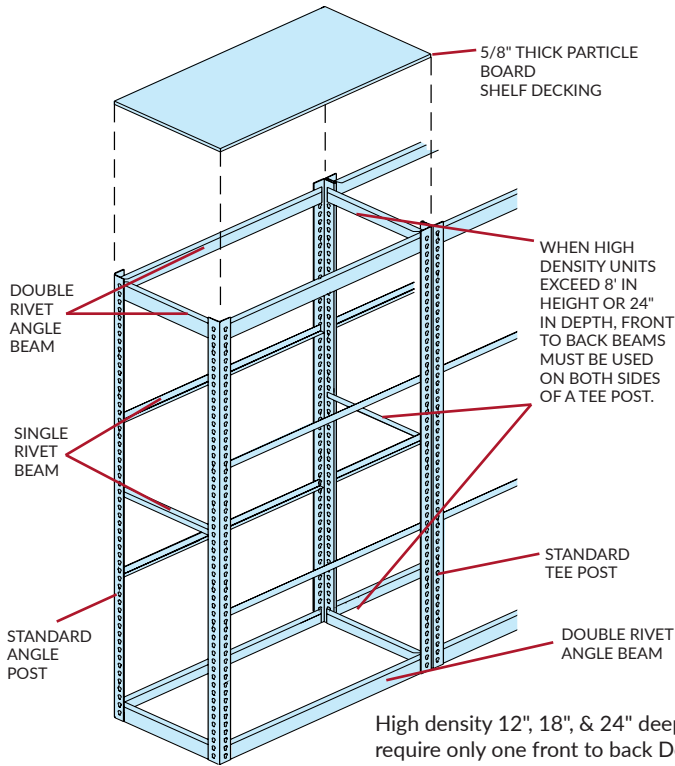

High density 12", 18", & 24" deep Add-On Units require only one front to back Double Rivet Angle Beam at unit top and bottom and one Single Rivet Shelf Beam for front to back at unit center.

Double Rivet Bulky Storage Units

Double Rivet bulky storage shelving uses double rivet beams on intermediate levels, and double rivet beams at the top and bottom for rigidity. For units up to 48" wide.

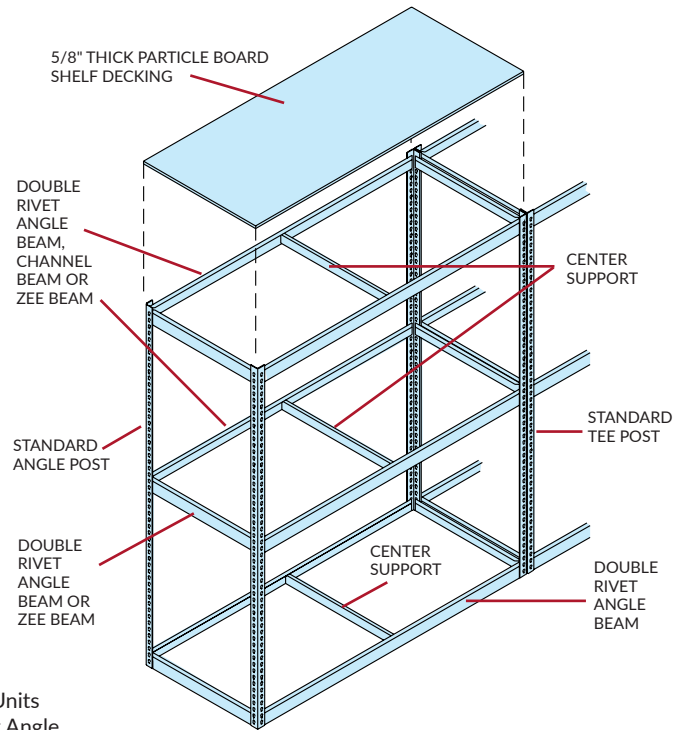

Single Rivet Units

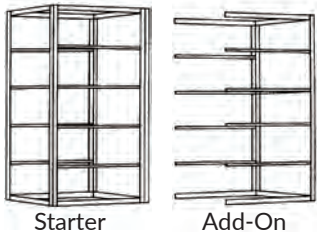

Double Rivet Units

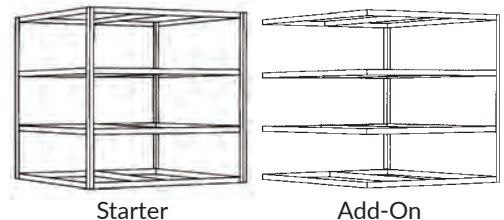

Starters and Adders



Starter and Add-On units are combined to form economical rows of shelving. Each Add-On unit includes a pair of tee posts which are used in common between units. This reduces assembly time and the number of parts required. Begin each row with two angle posts from the starter unit and join the desired number of add-on units to complete the row. Finish the last unit with a pair of angle posts from the starter unit. All dimensions in the tables are in inches and are subject to change without notice.

Steps for Selecting Your RivetRite® Units

1. Review the catalog and decide what type of unit will meet your requirement.
2. Determine the shelf size desired and select the capacity needed. Note the capacity shown is for the steel structure only.
3. Next determine the type of shelf deck material and calculate the quantity. Note that none of the unit catalog numbers include decking. Flat wire decking is plated.
4. All starter units are furnished with four Angle Posts. Add-on units have two intermediate Tee Posts. When assembling units, always

5. put the Angle Posts at the extreme ends of the shelving row. Note that shelving growth will always occur; see Growth Chart on pg. 38.
5. When ordering piece parts from the Component Parts pages of the catalog, contact your Penco representative for guidance on piece part capacities and product application to ensure structural integrity.



Single Rivet Units: Up to 48" Wide

Single Rivet High Density Units

Single Rivet High Density shelving uses single rivet beams on intermediate levels, and double rivet beams on all four sides at the top and bottom for rigidity. For units up to 48" wide.

Starter and add-on units are combined to form economical rows of shelving. Each add-on unit includes a pair of tee posts which are used in common between units. This reduces assembly time and the number of parts required. Begin each row with two angle posts from the starter unit and join the desired number of add-on units to complete the row. Finish the last unit with a pair of angle posts from the starter unit.

All intermediate shelves on units that exceed 24" deep utilize single rivet beams for front to back shelf deck support.

Units 12", 18" and 24" deep include one pair of single rivet beams for intermediate use front to back.

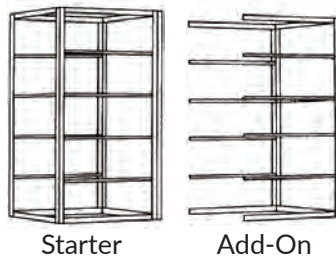

- High Density Single Rivet Shelf Beams provide maximum space between shelf levels
- Common tee posts between starter and add-on unit
- Shelf levels adjust on 1-1/2" centers
- Fast easy assembly
- No special tools needed
- Optional heavy duty single rivet shelf beams available for added capacity



* Capacities shown are for the steel support beams, not the shelf deck material. For higher support beam capacity, see "RivetRite Components". Capacities are in pounds for evenly distributed loads. All unit catalog numbers include metal framing only. Shelf deck material must be ordered separately.

Single Rivet High Density Units (84" High)

Unit Width	Shelf Depth	Shelf Capacity*	5 Shelf Cat. No.	6 Shelf Cat. No.	7 Shelf Cat. No.	8 Shelf Cat. No.
36" Starter Units	12"	350	461315	461316	461317	461318
	18"	350	461325	461326	461327	461328
	24"	350	461335	461336	461337	461338
	36"	350	461345	461346	461347	461348
36" Add-On Units	12"	350	462355	462356	462357	462358
	18"	350	462365	462366	462367	462368
	24"	350	462375	462376	462377	462378
	36"	350	462385	462386	462387	462388
48" Starter Units	12"	250	461415	461416	461417	461418
	18"	250	461425	461426	461427	461428
	24"	250	461435	461436	461437	461438
	36"	250	461445	461446	461447	461448
48" Add-On Units	12"	250	462455	462456	462457	462458
	18"	250	462465	462466	462467	462468
	24"	250	462475	462476	462477	462478
	36"	250	462485	462486	462487	462488

Double Rivet Units: Up to 96" Wide



Double Rivet Units

Double Rivet Units use the same posts and top and bottom perimeter beams as single rivet units, however all intermediate beams are of double rivet construction. Units are either 84" or 120" high. Some units have center supports for higher capacity and some units have channel beams in place of angle beams for heavier loads.

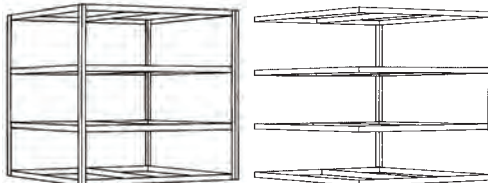

Starter

Add-On



Double Rivet Bulky Storage Units (With 4 Shelves - 84" High)

Unit	Beam	Shelf	WITHOUT Center Support			WITH Center Support		
			Shelf Capacity*	Starter Cat. No.	Add-On Cat. No.	Shelf Capacity*	Starter Cat. No.	Add-On Cat. No.
48" Wide Units	Heavy Duty Angle	18"	750	46001H	46006H	1400	46W01H	46W06H
		24"	750	46002H	46007H	1400	46W02H	46W07H
		30"	750	46003H	46008H	1310	46W03H	46W08H
		36"	750	46004H	46009H	1220	46W04H	46W09H
		48"	750	46005H	46010H	1125	46W05H	46W10H
60" Wide Units	Heavy Duty Angle	18"	600	46011H	46016H	1200	46W11H	46W16H
		24"	600	46012H	46017H	1200	46W12H	46W17H
		30"	600	46013H	46018H	1200	46W13H	46W18H
		36"	600	46014H	46019H	1200	46W14H	46W19H
		48"	600	46015H	46020H	1200	46W15H	46W20H
	Channel	18"	-	-	-	2240 (1)	46W01C	46W06C
		24"	-	-	-	2240 (1)	46W02C	46W07C
		30"	-	-	-	2240 (1)	46W03C	46W08C
		36"	-	-	-	2240 (1)	46W04C	46W09C
		48"	-	-	-	2240 (1)	46W05C	46W10C
72" Wide Units	Heavy Duty Angle	18"	500	46021H	46026H	1000	46W21H	46W26H
		24"	500	46022H	46027H	1000	46W22H	46W27H
		30"	500	46023H	46028H	1000	46W23H	46W28H
		36"	500	46024H	46029H	1000	46W24H	46W29H
		48"	500	46025H	46030H	1000	46W25H	46W30H
	Channel	18"	-	-	-	1850	46W11C	46W16C
		24"	-	-	-	1850	46W12C	46W17C
		30"	-	-	-	1850	46W13C	46W18C
		36"	-	-	-	1850	46W14C	46W19C
		48"	-	-	-	1850	46W15C	46W20C
96" Wide Units	Heavy Duty Angle	18"	-	-	-	620	46W31H	46W36H
		24"	-	-	-	620	46W32H	46W37H
		30"	-	-	-	620	46W33H	46W38H
		36"	-	-	-	620	46W34H	46W39H
		48"	-	-	-	620	46W35H	46W40H
	Channel	18"	-	-	-	1400	46W21C	46W26C
		24"	-	-	-	1400	46W22C	46W27C
		30"	-	-	-	1400	46W23C	46W28C
		36"	-	-	-	1400	46W24C	46W29C
		48"	-	-	-	1400	46W25C	46W30C

Double Rivet Bulky Storage Units (With 5 Shelves - 120" High)

Unit	Beam	Shelf	WITHOUT Center Support			WITH Center Support		
			Shelf Capacity*	Starter Cat. No.	Add-On Cat. No.	Shelf Capacity*	Starter Cat. No.	Add-On Cat. No.
72" Wide Units	Heavy Duty Angle	30"	500	46041H	46044H	1000	46W41H	46W44H
		36"	500	46042H	46045H	1000	46W42H	46W45H
		48"	500	46043H	46046H	1000	46W43H	46W46H
	Channel	30"	-	-	-	1850 (2)	46W31C	46W34C
		36"	-	-	-	1850 (2)	46W32C	46W35C
		48"	-	-	-	1850 (2)	46W33C	46W36C
96" Wide Units	Heavy Duty Angle	30"	-	-	-	620	46W47H	46W50H
		36"	-	-	-	620	46W48H	46W51H
		48"	-	-	-	620	46W49H	46W52H
	Channel	30"	-	-	-	1400	46W37C	46W40C
		36"	-	-	-	1400	46W38C	46W41C
		48"	-	-	-	1400	46W39C	46W42C

*Capacities shown are for the steel support beams, not the shelf deck material. For higher support beam capacity, see "RivetRite Components". Capacities are in pounds for evenly distributed loads. All unit catalog numbers include metal framing only. Shelf deck material must be ordered separately. All Double Rivet Bulky Storage Units with Channel Beams are furnished with Heavy Duty Double Rivet Angle Beams (left to right) at the bottom level. (1) - Max. Average Shelf Load 2000# per shelf. (2) - Max. Shelf Load 1490# per shelf.

Record Storage Shelving

Keep Your Records Organized!

- Assembles without special tools
- Records can be retrieved from both sides
- Units can be added as needed
- 42" wide units hold 3 boxes across
- 69" wide units hold 5 boxes across
- Various unit heights are available



80 Box Unit with Decking
Cat. No. 46604A
(Order decking separately)

(Boxes are not Included)



80 Box Unit with
Steel Box Supports Cat. No. 46708A

Record Storage Units

RivetRite Record Storage Units aid in records management by providing an organized solution for high density archive storage applications.

Add-on units utilize a common Tee Post between units to save time during assembly.

Inventory Systems



Tire Storage Rack

Penco RivetRite® Tire Racks provide for the neat organized storage of standard automobile or light truck tires. Specially designed beams with a 30° flange on the top securely cradle the tires. Available in Single-Row, (12" deep units with 9" Wall Ties) and Double-Row, (two 12" deep units separated by 18" Double Row Spacers). Unit depth shown includes wall ties/row spacers. Deeper units are available to accommodate larger SUV tires.

Record Storage Units

For Use With Decking (order deck material separately)

Unit Width	Unit Depth	Unit Height	No. of Shelves	No. of Boxes*	Starter Cat. No.	Add-On Cat. No.
42"	15"	84"	4	24	46601A	46613A
42"	30"	84"	4	48	46602A	46614A
69"	15"	84"	4	40	46603A	46615A
69"	30"	84"	4	80	46604A	46616A
42"	15"	108"	5	30	46605A	46617A
42"	30"	108"	5	60	46606A	46618A
69"	15"	108"	5	50	46607A	46619A
69"	30"	108"	5	100	46608A	46620A

Passenger Tire Storage Rack

Single Row

Unit Width	Unit Depth	Unit Height	No. of Levels	Tire Capacity*	Starter Cat. No.	Add-On Cat. No.
60"	21"	84"	3	24	46351C	46451C
60"	21"	120"	4	32	46352C	46452C

Double Row

Unit Width	Unit Depth	Unit Height	No. of Levels	Tire Capacity*	Starter Cat. No.	Add-On Cat. No.
60"	42"	84"	3	48	46355C	46455C
60"	42"	120"	4	64	46356C	46456C

NOTE: Tire rack capacities are based on average passenger tire sizes.
** Supplied with Heavy Duty Posts.

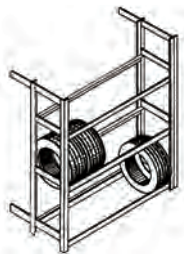

Single Row Starter

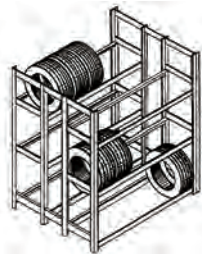

Double Row Starter

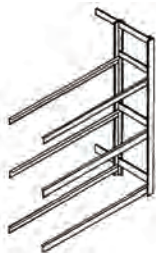

Single Row Add-On

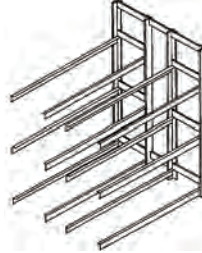

Double Row Add-On



Muller Storage Unit

Provides sturdy storage for mufflers or other inventory items. All double rivet beam construction. Available in 48" and 96" widths in both starter and add-on configurations.

Muller Storage Units

Unit Width	Unit Depth	Unit Height	Starter Cat. No.	Add-On Cat. No.
48"	36"	84"	46801M	46803M
96"	36"	84"	46802M	46804M



Hanging Tailpipe Rack

Designed specifically for the storage of automotive and light truck tailpipes. Assembles in minutes without special tools. Stored items are visible and easily accessible. Hanging hooks are not provided by Penco.

Hanging Tailpipe Rack

Clear Span	Unit Depth	Unit Height	Cat. No.
48"	18"	120"	46901P
96"	18"	120"	46902P

Two-Level Storage

The structural integrity of RivetRite lends itself to the construction of two-level storage facilities for applications where maximum utilization of overhead space is required. Expanding in an upward direction instead of outward keeps your personnel in closer proximity to each other and stored material, for more efficient operation.

Using standard components for support, economical units may be constructed with an open "deck-over" upper level, or additional shelving. In either case, savings are realized because:

- You virtually double the amount of storage space in a given floor area
- You utilize existing heat and air conditioning within the building

Various components in addition to RivetRite may be used to create a multi-level structure, and these are also used for multi-level structures for other types of shelving and work platforms manufactured by our sister company, Schmidt Structural Products.

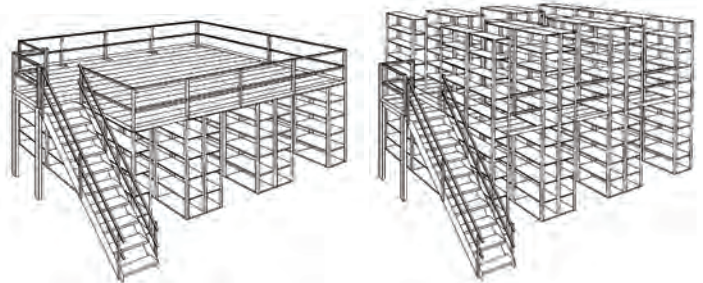

Deck-over unit provides an unrestricted work area.

Shelving on both levels for high density storage.



Stairs: All applications involving stairs are reviewed individually and designed to meet or exceed local, state and federal codes in effect at the location where the stairs are to be installed.

Side frames are made from heavy duty MC10 structural steel. Handrails and inner handrails are welded in place, and all parts are finished with an attractive, durable powder coat finish.

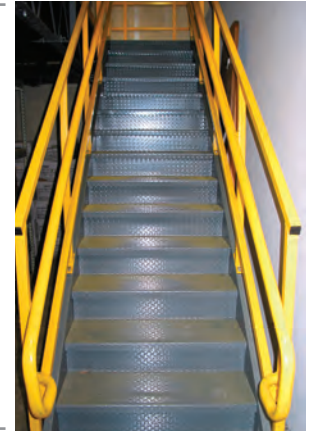
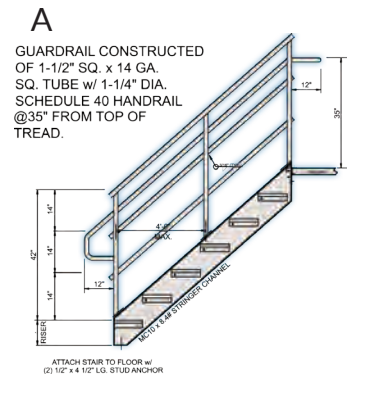

A. - Handrail & Kickplate: Penco handrail is designed for either two or three rails, depending on code requirements. It has welded tubular steel uprights and cross-rails with heavy gauge kickplate. All are finished with an attractive, durable powder coat finish.

B. - Landings: Landings for stairs feature a heavy duty 1/8" diamond plate decking, handrail and kickplate on two sides and four column supports.

Two-column pedestal supported units are also available. Special sizes and baluster handrails are also available. All are finished with an attractive, durable powder coat finish.

For Stairs, Handrails, Kickplate, and Landings please contact your District Manager for more information.

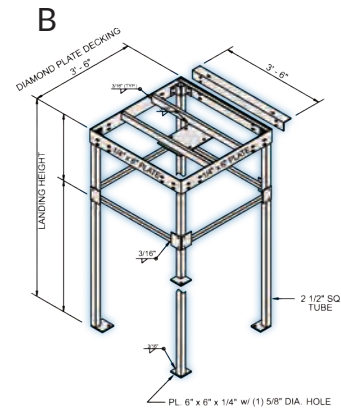

Components



Posts

Angle Posts

Standard Duty Angle:

1-1/2" x 1-1/2". Used as upright post for standard RivetRite units. All Angle Posts allow for beam adjustments on 1-1/2" centers.

Heavy Duty Angle:

1-7/8" x 1-7/8". When greater capacity and stability are essential, the heavy duty angle post is the proper choice. Ideally suited for two level shelving, storage deck and high rise shelving applications.



Tee Posts

Standard Duty Tee:

3" x 1-1/2". Included with standard duty add-on units to function as a common post between the starter unit and adjoining units. All Tee Posts allow for beam adjustment on 1-1/2" centers.

Heavy Duty Tee:

3-3/4" x 1-7/8". Used in the same way as the standard tee, when increased load capacities are required.

RivetRite® Posts			
Item Desc.	Size	Standard Cat. No.	Hvy Duty Cat. No.
Angle Posts	36"	46AS03C	-
	48"	46AS04C	-
	60"	46AS05C	-
	72"	46AS06C	-
	84"	46AS07C	-
	96"	46AS08C	46AH08C
	108"	46AS09C	-
	120"	46AS10C	46AH10C
Tee Posts	36"	46TS03C	-
	48"	46TS04C	-
	60"	46TS05C	-
	72"	46TS06C	-
	84"	46TS07C	-
	96"	46TS08C	46TH08C
	108"	46TS09C	-
	120"	46TS10C	46TH10C

Beams

Single Rivet Shelf Beams

Standard Duty Single Rivet "SS":

Primarily used as an intermediate shelf support when maximum vertical space between levels is needed. Furnished as standard on High Density Shelving units.

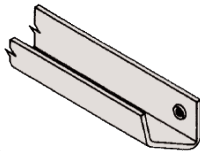

Heavy Duty Single Rivet "HS":

Manufactured to provide greater capacity with very little loss of usable vertical space between shelves.

Double Rivet Angle Beams

Standard Duty "SB":

Used to establish unit stability and to provide shelf support on all four sides.

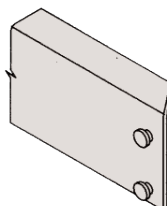

Heavy Duty "HB":

Provides stability and increased load capacity in the longer lengths.

RivetRite® Beams			
Item Desc.	Size	Standard Cat. No.	Hvy Duty Cat. No.
Single Rivet Shelf Beams	12"	46SS12C	-
	15"	46SS15C	-
	18"	46SS18C	-
	24"	46SS24C	-
	30"	46SS30C	-
"SS" & "HS"	36"	46SS36C	-
	42"	46SS42C	-
	48"	46SS48C	46HS48C**
	48"	46SS48C	46HS48C**
Double Rivet Angle Beams	12"	46SB12C	-
	15"	46SB15C	-
	18"	46SB18C	-
	24"	46SB24C	-
	30"	46SB30C	-
	36"	46SB36C	-
	42"	46SB42C	-
	48"	-	46HB48C
"SB" & "HB"	60"	-	46HB60C
	69"	-	46HB69C
	72"	-	46HB72C
	84"	-	46HB84C
	96"	-	46HB96C

* Heavy Duty 36" support beam capacity is 600 lb. per pair.
** Heavy Duty 48" support beam capacity is 500 lb. per pair.

Double Rivet Channel Beams "CB":

3" x 1". Channel is designed to provide maximum left to right stability and higher capacity than standard or heavy duty beams. Cannot be used at floor level. The top flange has holes for fastening decking.

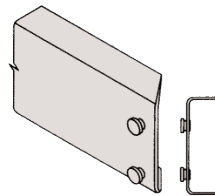

Tire Rack Beams "TB":

2-3/4" high - For left to right shelf support of tires. 30 degree angle on supporting edge of tire rack beam.

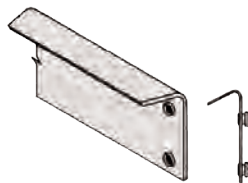

Beams, Continued		
Item Desc.	Size	Standard Cat. No.
Double Rivet Channel Beams "CB"	60"	46CB60C
	72"	46CB72C
	84"	46CB84C
	96"	46CB96C
Tire Rack Beams "TB"	48"	46TB48C
	60"	46TB60C

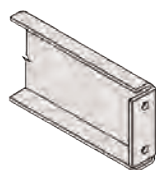

Center Support:

Used with double rivet beams to provide front-to-rear support for shelf deck and provides added stability to beams. Hardware included.



Post Splice:

1-3/8" x 1-3/8". Used to extend posts. Order one per angle post. Order two per tee post. Note: installs on the outside of the post.

Beams, Center Supports & Splice		
Item Desc.	Size	Standard Cat. No.
Center Support with Hardware	12"	46CS12
	15"	46CS15
	18"	46CS18
	24"	46CS24
	30"	46CS30
	36"	46CS36
	42"	46CS42
	48"	46CS48
Post Splice	1-3/8" x 1-3/8"	46PS0H

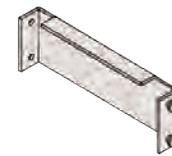

Wall Tie:

Used to secure units to wall and provide space between wall and attached units. Hardware is not included.

Double Row and Top Ties:

Designed to space back-to-back units and to top-tie rows across aisles for additional stability.



Concrete Anchors:



Used to secure posts to the floor (foot plates are used). Available in 2 lengths; the 2-1/4" length is sufficient for most usage, but areas with a high seismic rating may require the 3-3/4" length.

Foot Plate & Shim:

Foot Plate includes hardware, for anchoring angle and tee posts to the floor. NOTE: foot plate cannot be used if there is a double rivet channel beam at the lowest point.



Shim (14 ga.) is for placement beneath footplate if floor is uneven.

Ties and Anchors		
Description	Size	Std. Cat. No.
Wall Tie	9-1/4"	46WT09C
Double Row and Top Ties	18-1/4"	46RT18C
Concrete Anchors	3/8" x 2-1/4"	9280
	3/8" x 3-3/4"	9281
Foot Plate	-	46FPOH
Shim (plated)	3-1/2" x 2"	46FPS00Z

Technical Information - Growth/Width/Beams

Unit Growth Chart

WHEN DESIGNING A SHELVING LAYOUT, UNIT GROWTH MUST BE CONSIDERED. TO DETERMINE THE OVERALL DIMENSION OF A CONTINUOUS ROW OF SHELVING EMPLOYING TEE POSTS OR ANGLE POST WITH TIE PLATES.

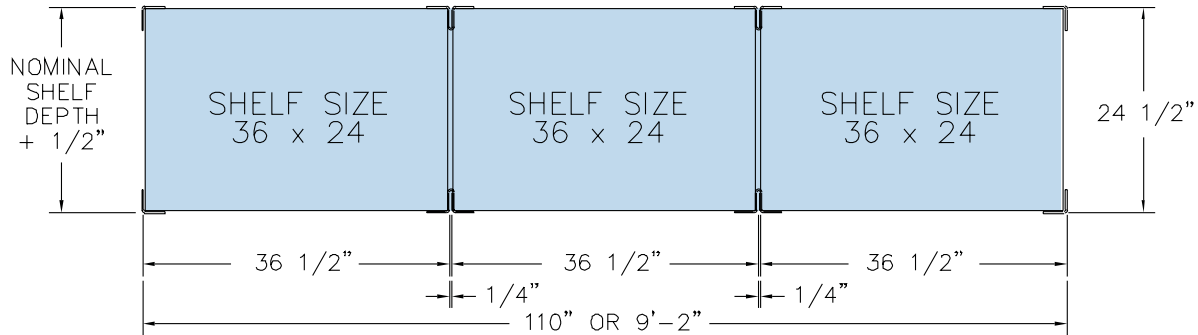

Unit Clear Width

EXAMPLES BELOW ARE BASED ON 36" WIDE SHELF

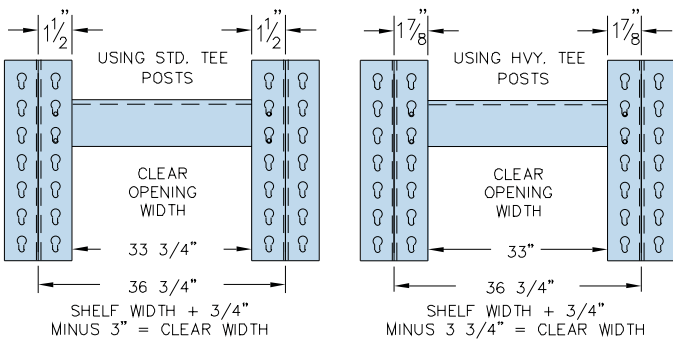
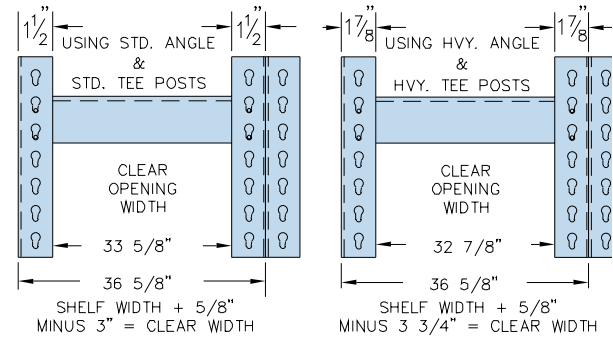
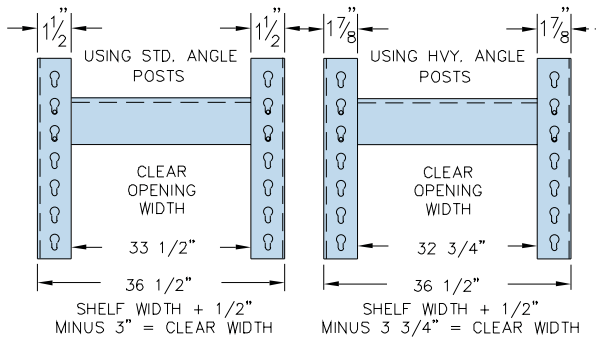

Beam Profiles

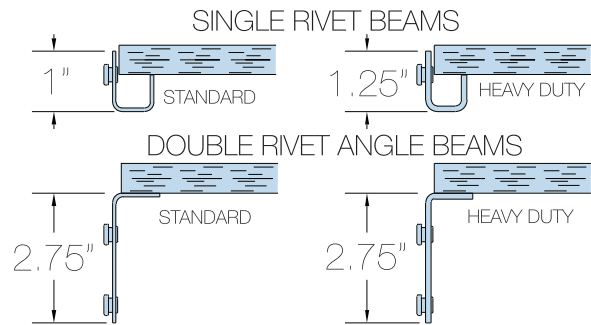

DOUBLE RIVET CHANNEL

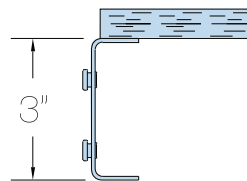

RivetRite®

Technical Information - Vertical Clear Openings

Vertical Clear Opening Using 5/8" Shelf Deck Material

UNITS USING SINGLE RIVET SHELF BEAMS

UNITS WITH STANDARD DUTY SINGLE RIVET BEAMS (DBL. RIVET AT TOP and BOTTOM)

UNITS WITH HEAVY DUTY SINGLE RIVET BEAMS (DBL. RIVET AT TOP and BOTTOM)

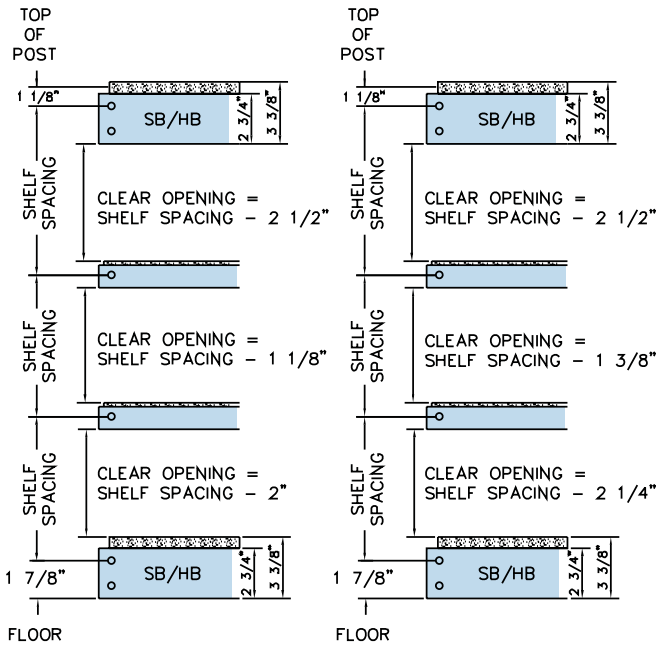

UNITS USING ANGLE AND CHANNEL BEAMS

UNITS WITH ZEE BEAMS

UNITS WITH ANGLE BEAMS AND CHANNEL BEAMS

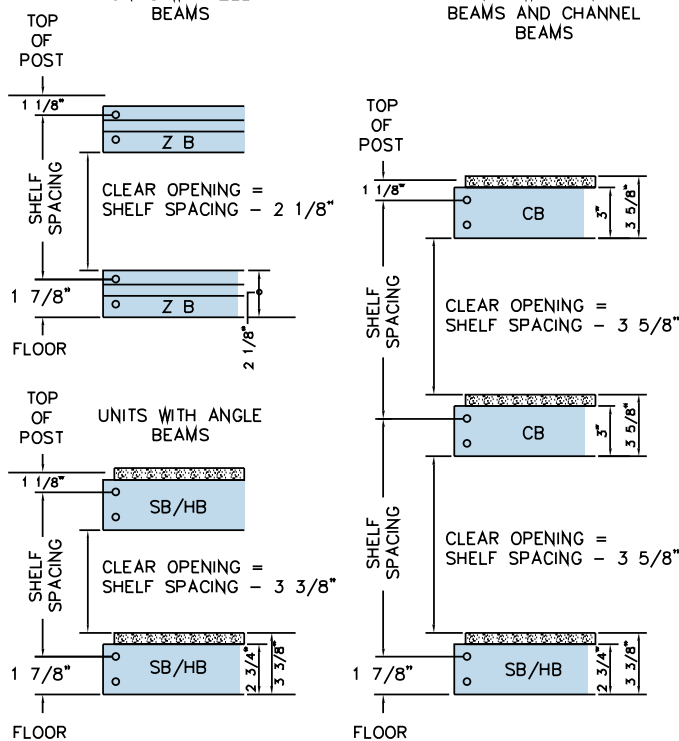

VERTICAL SHELF CLEARANCE

THIS CHART DEPICTS SHELF CLEARANCES FOR TYPICAL RIVET RITE SHELVING UNITS WITH 1 1/2" VERTICAL SHELF ADJUSTMENT.

SINGLE RIVET HIGH DENSITY SHELVING UNITS

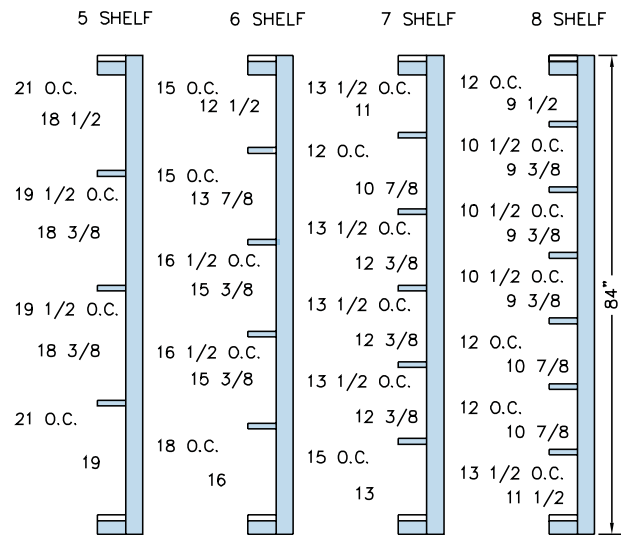

DOUBLE RIVET BULKY SHELVING UNITS

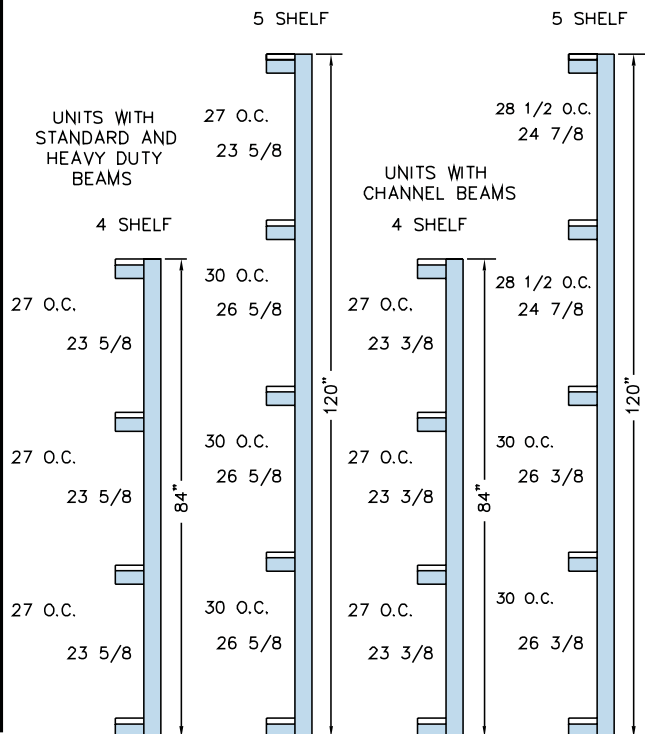



QuickShip Components



RivetRite® QuickShip Shelving Components

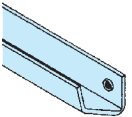
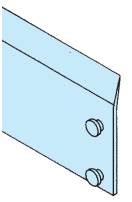

If you prefer to order RivetRite by its individual component, you can obtain many of the most popular sizes and accessories through the QuickShip program. By mixing beam sizes, you can create some sizes that are not available as pre-configured units on the previous page.

For detailed descriptions of components, see pages 32-34. All RivetRite QuickShip items are finished in 723 Light Putty powder coat paint. See beam capacities on page 35.

Shelf deck material is not available in the QuickShip program. It must be obtained outside the QuickShip program or purchased locally (particleboard supplied by Penco on a production order basis is classified as '1-M-1 Interior Grade'). If you are cutting your own board, use the nominal shelf deck size and cut +0", -1/8".

RivetRite® Beams				
	Item	Size	Cat. No.	
	Single Rivet Shelf Beams	12"	46SS12P	
		18"	46SS18P	
		24"	46SS24P	
		30"	46SS30P	
		"SS" & "HS"*	36"	46SS36P
			42"	46SS42P
			48"	46SS48P
			48"	46HS48P *
	Double Rivet Angle Beams	12"	46SB12P	
		15"	46SB15P	
		18"	46SB18P	
		24"	46SB24P	
		"SB" & "HB"*	30"	46SB30P
			36"	46SB36P
			42"	46SB42P
			48"	46HB48P*
			60"	46HB60P*
			69"	46HB69P*
			72"	46HB72P*
			84"	46HB84P*
96"	46HB96P*			

RivetRite® Posts			
	Item	Size	Cat. No.
	Angle Posts	72"	46AS06P
		84"	46AS07P
		96"	46AS08P
		120"	46AS10P
			Tee Posts
84"	46TS07P		
96"	46TS08P		
120"	46TS10P		

Miscellaneous Accessories			
	Item	Size	Cat. No.
	Tie Plate	-	46TP00P
	Foot Plate	-	46FPOH
	Concrete Anchor	3/8" x 2-1/4"	9280

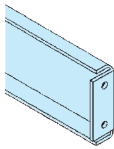
Center Supports			
	Item	Size	Cat. No.
	Center Support with Hardware	15"	46CS15P
		18"	46CS18P
		24"	46CS24P
		30"	46CS30P
		36"	46CS36P
		48"	46CS48P



RivetRite® QuickShip Shelving Units

- Quick Shipment in attractive 723 Light Putty powder coat finish
- Economical
- Choice of beam types
- Accessibility on all four sides
- Beams adjust on 1-1/2" vertical centers
- Boltless construction for easy assembly
- Starter & Adder configurations with Angle & Tee Posts
- Accessories available: Anchors, Foot Plates, Tie Plates



NOTE: Shelf Deck material is NOT included with the units. You must obtain shelf deck material separately.

Single Rivet High Density Units (With Double Rivet Beams at Top/Bottom - 84" High)					
Unit Width	Shelf Depth	5 Shelf Cat. No.	6 Shelf Cat. No.	7 Shelf Cat. No.	8 Shelf Cat. No.
36" Starter Units	12"	461315P	461316P	461317P	461318P
	18"	461325P	461326P	461327P	461328P
	24"	461335P	461336P	461337P	461338P
	36"	461345P	461346P	461347P	461348P
36" Add-On Units	12"	462355P	462356P	462357P	462358P
	18"	462365P	462366P	462367P	462368P
	24"	462375P	462376P	462377P	462378P
	36"	462385P	462386P	462387P	462388P
48" Starter Units	12"	461415P	461416P	461417P	461418P
	18"	461425P	461426P	461427P	461428P
	24"	461435P	461436P	461437P	461438P
	36"	461445P	461446P	461447P	461448P
48" Add-On Units	12"	462455P	462456P	462457P	462458P
	18"	462465P	462466P	462467P	462468P
	24"	462475P	462476P	462477P	462478P
	36"	462485P	462486P	462487P	462488P



Starter



Add-On

Double Rivet Bulky Storage Units (With 4 Shelves - 84" High)

Unit Width	Shelf Depth	WITHOUT Center Support		WITH Center Support	
		Starter Cat. No.	Add-On Cat. No.	Starter Cat. No.	Add-On Cat. No.
48" Wide Units	18"	46001HP	46006HP	46W01HP	46W06HP
	24"	46002HP	46007HP	46W02HP	46W07HP
	30"	46003HP	46008HP	46W03HP	46W08HP
	36"	46004HP	46009HP	46W04HP	46W09HP
	48"	46005HP	46010HP	46W05HP	46W10HP
60" Wide Units	18"	46011HP	46016HP	46W11HP	46W16HP
	24"	46012HP	46017HP	46W12HP	46W17HP
	30"	46013HP	46018HP	46W13HP	46W18HP
	36"	46014HP	46019HP	46W14HP	46W19HP
	48"	46015HP	46020HP	46W15HP	46W20HP
72" Wide Units	18"	46021HP	46026HP	46W21HP	46W26HP
	24"	46022HP	46027HP	46W22HP	46W27HP
	30"	46023HP	46028HP	46W23HP	46W28HP
	36"	46024HP	46029HP	46W24HP	46W29HP
	48"	46025HP	46030HP	46W25HP	46W30HP
96" Wide Units	18"	-	-	46W31HP	46W36HP
	24"	-	-	46W32HP	46W37HP
	30"	-	-	46W33HP	46W38HP
	36"	-	-	46W34HP	46W39HP
	48"	-	-	46W35HP	46W40HP

Double Rivet Bulky Storage Units (With 5 Shelves - 120" High)

Unit Width	Shelf Depth	WITHOUT Center Support		WITH Center Support	
		Starter Cat. No.	Add-On Cat. No.	Starter Cat. No.	Add-On Cat. No.
72" Wide Units	30"	46041HP	46044HP	46W41HP	46W44HP
	36"	46042HP	46045HP	46W42HP	46W45HP
	48"	46043HP	46046HP	46W43HP	46W46HP
96" Wide Units	30"	-	-	46W47HP	46W50HP
	36"	-	-	46W48HP	46W51HP
	48"	-	-	46W49HP	46W52HP

Archive Shelving Units (For Use with Decking - 84" High)

Unit Width	Shelf Depth	5 Shelf Cat. No.
42" Starter Units	15"	46601AP
	30"	46602AP
42" Add-On Units	15"	46613AP
	30"	46614AP
69" Starter Units	15"	46603AP
	30"	46604AP
69" Add-On Units	15"	46615AP
	30"	46616AP

Capacities

RivetRite Post Capacity Chart		
Recommended safe loads (per post) for use only where seismic forces are not a factor.		
Beam Spacing (inches)	Standard Angle Post Capacity (lbs.)	Heavy Duty Angle Post Capacity (lbs.)
12	1530	1735
18	1520	1720
24	1510	1695
30	1490	1680
36	1350	1660
42	990	1560
48	755	1195
Beam Spacing (inches)	Standard Tee Post Capacity (lbs.)	Heavy Duty Tee Post Capacity (lbs.)
12	4725	5045
18	4510	4965
24	4210	4850
30	3825	4705
36	3350	4525
42	2795	4315
48	2180	4075
For beam spacing over 48", please contact Penco.		
Post capacities are based on the maximum vertical distance between left to right beams or front to back beams, whichever is greater. In single rivet beam units, the vertical distance between front to back beams will usually govern.		
Tie plates must be spaced no more than 48 inches apart to insure structural stability when joining angle posts together.		
The above capacities are NOT intended for use when designing multi-level systems or for specific requirements where seismic forces are a factor. For specific multi-level or seismic requirements, contact your Penco District Manager.		

RivetRite Beam Capacities Recommended Safe Use Allowable Uniformly Distributed Hand Loaded Static Beam Loads		
Length (in.)	Cap./Pair (lbs.)	Deflection (in.)
Single Rivet Shelf Beams		
Standard Beams		
36	350	0.25
42	300	0.30
Heavy Duty Beams		
48	500	0.34
Double Rivet Angle Beams		
Standard Beams		
Without Center Supports (***)		
36	1000	***
42	780	***
Heavy Duty Beams		
Without Center Supports (***)		
48	750	***
60	600	***
69	525	***
72	500	***
With Center Supports (*)		
48	1400	0.16
60	1200	0.25
69	1050	0.33
72	1000	0.36
84	840	0.49
96	620	0.53
Double Rivet Channel Beams		
With Center Supports (*)		
60	2240	0.23
72	1850	0.33
84	1600	0.45
96	1400	0.59
(*) One (1) support per pair of beams except 96' which have two (2) Supports		
(***) Beam rotation is less than 5 degrees		



Components: Choose from a wide selection of component sizes and capacities to fit the storage requirements.

Angle Post: 1-1/2" x 1-1/2" (Standard Duty): Used as upright post for standard RivetRite units.

Angle Post: 1-7/8" x 1-7/8" (Heavy Duty): When maximum capacity and stability are essential, the heavy duty angle post is the proper choice. Ideally suited for two level shelving, storage deck and high rise shelving applications.

Tee Post: 3" x 1-1/2" (Standard Duty): Included with standard duty add-on units to function as a common post between starter and adjoining units.

Tee Post: 3-3/4" x 1-7/8" (Heavy Duty): Used in the same way as the standard tee, when increased load capacities are required.

Single Rivet Shelf Beam (Standard Duty): Primarily used as an intermediate shelf support when maximum vertical space between levels is needed. Furnished as standard on High Density Shelving units.

Single Rivet Shelf Beam (Heavy Duty): Manufactured to provide maximum capacity with very little loss of usable vertical space between shelves.

Double Rivet Shelf Beam (Standard Duty): Used to establish unit stability and to provide shelf support on all four sides.

Double Rivet Shelf Beam (Heavy Duty): Provides stability and increased load capacity in the longer lengths.

Double Rivet Channel Beam: Designed to provide maximum left to right stability and higher capacity than standard or heavy duty beams. Cannot be used at floor level.

Center Support: Used with double rivet beams to provide front-to-rear support for shelf deck and provides added stability to beams.

Double Rivet Low Profile Beams: Designed to provide maximum clear shelf spacing for Double Rivet Shelf Units with light load requirements.

Double Rivet Zee Step Beams: Reduced profile increases vertical clearance by 1-1/4" between shelf levels when used in place of Double Rivet Angle Beams. Protects decking edges. When used as the bottom shelf on Single Rivet Units clear space between the bottom and first shelf is increased by 1-1/4".

Decking Support For Zee Step Beam: Used with Zee Step Beams for front to back decking support.

TYPES OF UNITS: RivetRite Units come in two basic types: Single Rivet Units and Double Rivet Units. These utilize different combinations of beam types. In addition, units for special purposes include Records Storage Units and Automotive Parts Storage Units.

Double Rivet Bulky Storage Units: 48" to 96" wide beams Access to stored items from all sides Choice of beam capacity to meet your storage requirement Easy assembly without special tools Units available in 84" and 120" heights Penco RivetRite bulky shelving is designed to provide an economical solution for the storage of retail, wholesale or industrial goods. Installation can be done without special tools in a minimum amount of time. All steel parts are finished in attractive 723 Light Putty baked enamel. v Starter and add-on units are combined to form economical rows of shelving. Each add-on unit includes a pair of tee posts which are used in common between units. This reduces assembly time and the number of parts required. Begin each row with two angle posts from the starter unit and join the desired number of add-on units to complete the row. Finish the last unit with a pair of angle posts from the starter unit.

Single Rivet High Density Units: Single Rivet high density shelving uses single rivet beams on intermediate levels, and double rivet beams at the top and bottom for rigidity. For units up to 48" wide. High Density Shelf Beams provide maximum space between shelf levels Common tee posts between starter and add-on unit Shelf levels adjust on 1-1/2" centers Fast easy assembly Optional heavy duty single rivet shelf beams available for added capacity Penco Single Rivet beam High Density shelving is designed

to provide for maximum vertical clearance between shelves. Access to stored item from all sides is possible because side and back cross braces are not necessary for stability. Add-on units assemble quickly without special tools by using a common tee post between units. Finished in 723 Light Putty baked enamel. Starter and add-on units are combined to form economical rows of shelving. Each add-on unit includes a pair of tee posts which are used in common between units. This reduces assembly time and the number of parts required. Begin each row with two angle posts from the starter unit and join the desired number of add-on units to complete the row. Finish the last unit with a pair of angle posts from the starter unit. All intermediate shelves on units that exceed 24" deep utilize single rivet beams for front to back shelf deck support. Units 12", 18" and 24" deep include one pair of single rivet beams for intermediate use front to back.

Record Storage Units: RivetRite Record Storage Units aid in records management by providing an organized solution to high density archive storage. Two types of units are available; one that utilizes particle board decking to support the boxes, and an all steel unit with specially designed box supports. (Particle board must be ordered separately). Fire insurance premium savings may be realized by using units with steel box supports. Check with your insurance carrier. Add-on units utilize a common Tee Post between units to save time during assembly. All unit box capacities are based on a standard archive box size of approximately 12-1/2" wide x 16-1/2" deep x 10-1/2" high.

AUTOMOTIVE PARTS STORAGE UNITS

Tire Storage Rack: Penco RivetRite Tire Racks provide for the neat organized storage of standard automobile or light truck tires. Specially designed beams with a 30 degree flange on the top securely cradle the tires. Available in Single-Row, (12" deep units with 9" Wall Ties) and Double-Row, (two 12" deep units separated by 18" Double Row Spacers). Unit depth shown includes wall ties/row spacers.

Muffler Storage: Uniform storage of various size mufflers is achieved through the use of RivetRite Muffler Storage Units. As with all RivetRite units, ease of assembly and access from all sides is standard. Add-on units utilize common Tee Posts between units. Particle Board must be ordered separately for each level.

Hanging Tailpipe Rack: Designed specifically for the storage of automotive and light truck tailpipes. Assembles in minutes without special tools. Stored items are visible and easily accessible.

RivetRite Two-Level Storage: The structural integrity of RivetRite lends itself to the construction of two-level storage facilities for applications where maximum utilization of overhead space is required. Expanding in an upward direction instead of outward keeps your personnel in closer proximity to each other and stored material, for more efficient operation. Using standard components for support, economical units may be constructed with an open deck-over upper level, or additional shelving. In either case, savings are realized because: You virtually double the amount of storage space in a given floor area You utilize existing heat and air conditioning within the building Construction is as uncomplicated as standard single level shelving. Beams and grating supports lock into strong one-piece posts without hardware. Penco Channel-Lock Safety Grating installs easily for a rigid walking surface. The utility of a RivetRite two-level installation has unlimited possibilities. Shelf heights are adjustable on 1-1/2" centers Shelves can be accessed from all four sides RivetRite two level shelving systems are designed to meet your specifications. Contact your representative for assistance in reviewing your two-level shelving requirements.

RivetRite® is a registered trademarks of Penco Products, Inc.
PENCO RESERVES THE RIGHT TO VARY SPECIFICATIONS CONSISTENT WITH A POLICY OF CONTINUOUS PRODUCT IMPROVEMENT.

Introduction

Penco Pallet Rack

Penco Pallet Rack is a carefully engineered system designed to provide highly efficient storage of palletized items. Combining design and excellence with the use of high strength steel to achieve a superior strength to weight ratio, Penco Pallet Rack can handle nearly any storage job you can give it.

The basic components of Penco Pallet Rack are Upright Frames and Beams. Each is manufactured to exacting tolerances to provide many years of dependable service at their rated loads.

The following pages detail the wide range of sizes, capacities and accessories that make Penco Rack one of the best values for your storage dollar.



Available in
24 Colors
See Page 117

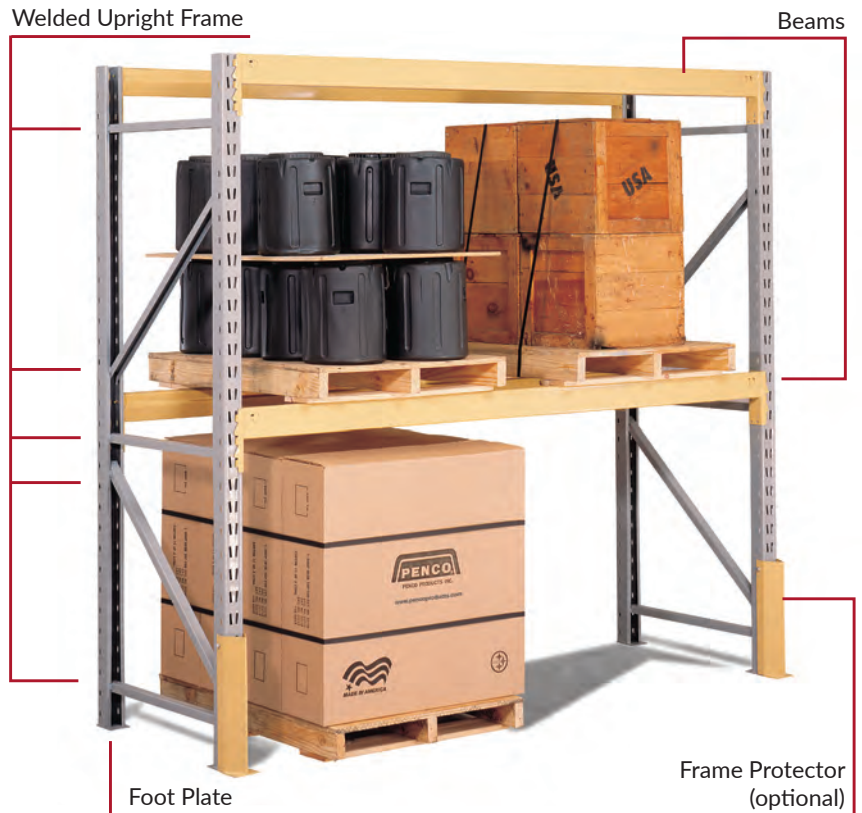

Design Features

Heavy Duty Beam End Connector

Beam ends are made from extra heavy gauge steel. They feature a three prong connection which assures positive beam to post alignment along the 8-1/2" length of the connector, and uniform load distribution. The greater the load, the tighter the connection. Tabs extend along the face of the beam to provide extra protection to the prongs during transit and installation.

Upright Column

A continuous post roll formed in 5 different shapes and 3 different metal thicknesses to handle a variety of loads. Slanted slots on the column allow for beam placement on 3" vertical centers. Slots on column sides accept the safety beam locking key. The design allows for beams to be placed flush with the top, or as close as 9" from the floor.

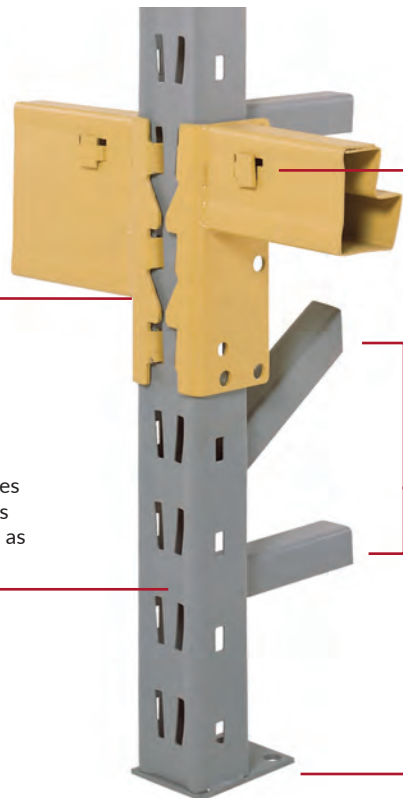

Beam Locking Key for Safety

A unique recessed safety key made from heavy gauge steel engages a slot in the side of the post. It resists an upward force from material handling equipment up to 1000 pounds. It is an integral part of the beam assembly, can be engaged easily without tools, and is clearly visible for checking.

Step Down Design

All beams have a step for the purpose of accepting accessories. Two step sizes are available: 7/8" and 1-5/8" high.

Welded Upright Frame Bracing

Upright frame columns are securely MIG welded together with channel type braces for maximum rigidity.

Foot Plate

A heavy gauge foot plate is securely welded to each post to provide load distribution over 13.7 square inches, and two holes allow for floor anchoring from either side of the frame.

Determining Pallet Rack Needs

- A. Height:** Measure the vertical dimensions of the pallet, pallet load and beam. Add an extra 4" to 6" clearance between bottom of beam above and top of load on pallet. Top beam should be at least 6" lower than the maximum lifting height of your forklift.
- B. Depth:** Measure the depth of the pallet. Pallet should overhang the frame by 3" front and back. (Example: for a 48" deep pallet use a 42" deep frame).
- C. Width:** Measure the width of the load and pallet, and use the greater of the two. Add 3" to 4" between loads, and between loads and upright frames to determine correct beam length. Select beams with a capacity equal to or greater than the total load of each level. (See "How to Order Beams" on the Pallet Rack Beam page).
- D. Frame Capacity:** Add the total weight of all loads for each bay, excluding the pallets on the floor (a bay is the space between two upright frames).
- E. Frame:** A common frame should be used between each bay.

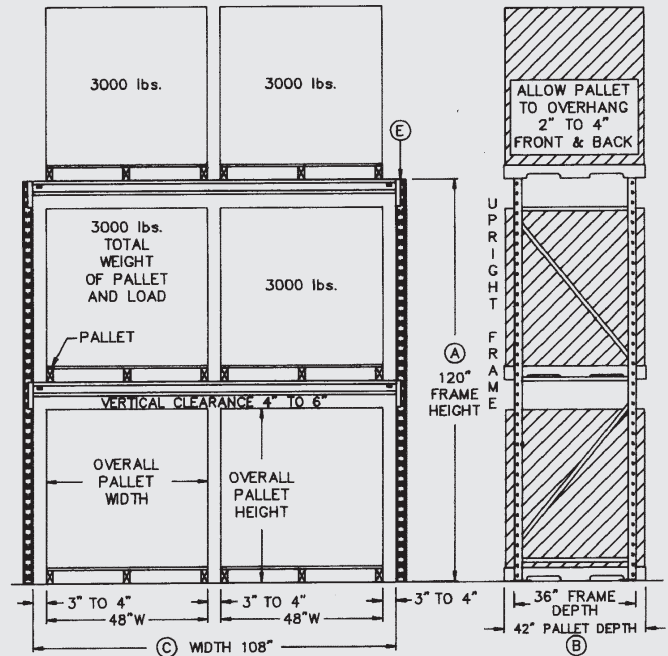

Pallet Rack Plus - An option for severe conditions or high seismic activity

Penco Pallet Rack Plus is engineered for use in areas where high seismic activity or other severe conditions exist. Load capacities are the same as the standard pallet rack shown in this catalog, however the frames and beams are more resistant to horizontal and vertical forces that could damage standard rack and its load. To learn the seismic rating where your pallet rack will be in use, contact your Penco representative.

Plus Beam End Connectors:

The Plus beams have 4 connectors instead of 3 for a stronger connection between

the beam and the upright post to resist conditions with higher lateral forces. The beam is welded 3" down from the top of the connector so loading is evenly distributed across all four connector prongs. The beam locking key is the same as used on standard beams.

Plus Upright Frames with Large Footplates:

Each Plus upright frame has two 5" x 7" x 3/8" thick footplates with four 9/16" diameter anchoring holes. The extra holes provide the installer with more choices for floor anchoring.

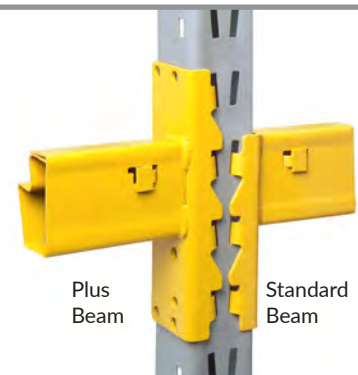
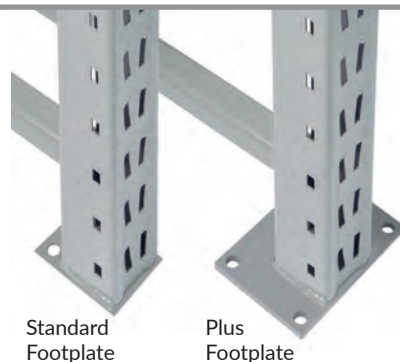
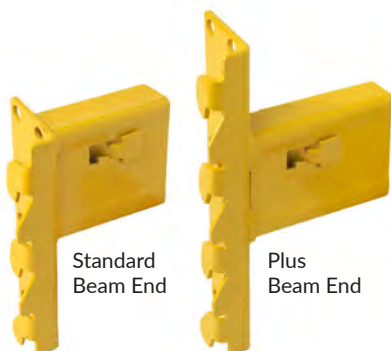

Upright Frames

Penco Pallet Rack Upright Frames are available in five load capacities. A letter code stamped into the face of the post indicates the frame type. Depths of 30", 36", 42", 48", 54" and 60" are standard, but other depths and double-posted and cantilever frames are available. Standard heights range from 48" to 240" in 6" increments, but greater heights can be achieved when splices are used.

Beam heights adjust on 3" vertical centers, and are independent on each side of the frame. Beams of any type can be placed along the full height of the post; there are no dead spots on the post, even across a splice. Various load rated frames can be combined in a row of rack for maximum economy.

Penco Pallet Rack Upright Frames are furnished completely fabricated, welded into rigid units.

Panel Construction:

Four standard types of panel construction are illustrated.

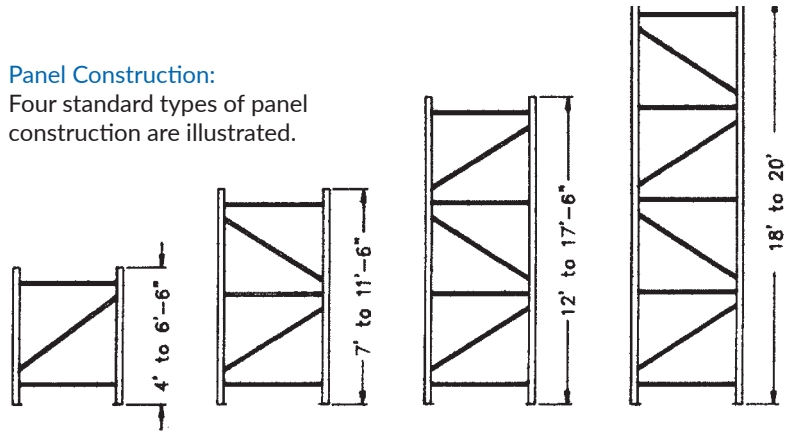

How To Select Upright Frame Type

1. Determine the maximum vertical opening dimension between pairs of beams or between the lowest beam level and the floor.
2. Calculate the total load imposed on the upright frame.
3. Using the charts below, find the maximum vertical spacing between beams along the bottom scale, and then draw a vertical line to intersect the lines representing the capacities of the five types of upright frames. Select the frame that has a capacity that equals or exceeds the total load imposed upon it by all beam levels.



Upright Frame Types

Frame Types	Post Width	Post Depth	Post Gauge
F	3"	1-3/4"	14
G	3"	2-1/4"	14
P	3"	3"	14
R	3"	3"	13
T	3"	3"	12

Upright Frame Capacity

Frame Type	Beam Spacing											
	24"	30"	36"	42"	48"	54"	60"	66"	72"	78"	84"	90"
F	22,555	21,213	19,853	18,528	16,929	15,381	13,543	11,773	9,824	8,439	7,216	6,336
G	26,512	25,236	23,839	22,311	20,663	18,904	17,025	15,015	12,864	10,774	9,306	8,110
P	32,751	31,227	29,555	27,932	25,965	24,342	21,871	19,203	17,212	14,630	12,540	11,026
R	39,108	37,264	35,464	33,266	30,891	28,339	25,934	23,043	19,959	17,245	14,796	12,834
T	45,629	43,478	41,102	38,503	35,715	32,703	29,897	26,489	22,875	19,432	16,713	14,527

The table above indicates capacities for various vertical beam spacings for the different Penco upright frame types. Load data shown is for preliminary consideration only. Each installation must be individually evaluated for actual conditions and the use of each element in relation to the entire system with all aspects of the structural function.

Upright Frame Accessories

Rigid Row Spacer

Structurally connects and spaces two rows of rack back-to-back. Bolted type. Hardware included.



Rigid Row Spacer	
Space	Cat. No.
6"	5AR506
8"	5AR508
10"	5AR510
12"	5AR512
18"	5AR518
24"	5AR524
30"	5AR530
36"	5AR536
42"	5AR542
48"	5AR548
54"	5AR554
60"	5AR560

Rigid Wall Spacer

Assures that uniform spacing between pallet rack and building wall is maintained. Frame hardware included.



Rigid Wall Spacer	
Space	Cat. No.
4"	5AR404
6"	5AR406
8"	5AR408
10"	5AR410
12"	5AR412
18"	5AR418

Reel Holder

Accessorizes rack for reel storage. Max. axle 2-1/2" dia. Cat. No. 5AH000



Concrete Floor Anchor

To anchor pallet rack upright frames to a concrete floor. 1/2" diameter x 3-3/4". High seismic areas may require other floor anchors. Check with local permitting agency for assistance, if required. Cat. No. 9580



Frame Protector

Anchors to floor at front of post. Provides protection against damage from material handling vehicles. NOT for use on Pallet Rack PLUS upright frames. Includes hardware to fasten to post only. 18" high. Cat. No. 5AF018



Frame Deflector

Fastens to post only, usually 1-1/2" above the footplate. Includes hardware to bolt to post. 18" High. Cat. No. 5AF021PC



Frame Splice

For adding to height of existing frame. Can be supplied welded in top of new frame if specified on order. (Top frame must be ordered without foot plate.) With hardware.



Frame Splice	
Frame Type	Cat. No.
F, G, P	5AU008P
R, T	5AU018P

Upright Frames - Available Sizes

Frame Height	Frame Depths					
	30"	36"	42"	48"	54"	60"
48"	I	I	I	I	I	I
54"	I	I	I	I	I	I
60"	I	I	I	I	I	I
66"	I	I	I	I	I	I
72"	I	I	I	I	I	I
78"	I	I	I	I	I	I
84"	I	I	I	I	I	I
90"	I	I	I	I	I	I
96"	I	I	I	I	I	I
102"	I	I	I	I	I	I
108"	I	I	I	I	I	I
114"	I	I	I	I	I	I
120"	I	I	I	I	I	I
126"	I	I	I	I	I	I
132"	I	I	I	I	I	I
138"	I	I	I	I	I	I
144"	I	I	I	I	I	I
150"	I	I	I	I	I	I
156"	I	I	I	I	I	I
162"	I	I	I	I	I	I
168"	I	I	I	I	I	I
174"	I	I	I	I	I	I
180"	I	I	I	I	I	I
186"	I	I	I	I	I	I
192"	I	I	I	I	I	I
198"	I	I	I	I	I	I
204"	I	I	I	I	I	I
210"	I	I	I	I	I	I
216"	I	I	I	I	I	I
222"	I	I	I	I	I	q
228"	I	I	I	I	I	q
234"	I	I	I	I	I	q
240"	I	I	I	I	I	q

I = Available q = Not Available

To add height to an Upright Frame, a splice can be added. For more information on splicing frames see the Frame Splice to the left.

Upright Frame Catalog # System

Position	1	2	3	4
Cat. No.	5	F	E	096

DESCRIPTION OF PART NO. SEQUENCE:

1. Always a 5 2. Capacity code for frame (See Pallet Rack Frame Capacities Table). 3. Depth code for frame (B = 30", E = 36", H = 42", L = 48", P = 54", S = 60") 4. Height of upright frame in inches (for example, 096 = 96 inches).

Pallet Rack Beams

One Piece Beam Design

Penco has engineered its roll-formed one piece beams to achieve the highest possible strength-to-weight ratios in the most frequently desired load ratings through the use of efficient design and high strength steel.

Beams are offered in eight basic styles with different vertical profiles and steel gauges. Beam step heights of 7/8" and 1-5/8" are available for a wide variety of accessory use. Both the overlapping seam and the beam end connector are securely MIG welded for strength.

The face of the beam has an M-design recessed configuration for added strength, protecting the locking key, and to accept pressure sensitive labeling. Each beam is stamped with an identifying letter referring to the load bearing capacity. Beams are shown in 710 Yellow.

How to Order Beams

- Select the Required Clear Span (distance between posts).** Allow for a minimum of 3" between pallet and post, and a minimum of 4" between adjacent pallets. Allow additional separation if load overhangs the pallet. For sizes not shown, contact your Penco representative.
- Determine the Required Capacity.** Add up the maximum load to be placed on one pair of beams. Remember that capacities are based on evenly distributed loading, not point loading.

Beam Selection

Clear Span*	B		D		H		J		N		S		X		Y	
	Capacity Per Pair**	Cat. No. Per Pair	Capacity Per Pair**	Cat. No. Per Pair	Capacity Per Pair**	Cat. No. Per Pair	Capacity Per Pair**	Cat. No. Per Pair	Capacity Per Pair**	Cat. No. Per Pair	Capacity Per Pair**	Cat. No. Per Pair	Capacity Per Pair**	Cat. No. Per Pair	Capacity Per Pair**	Cat. No. Per Pair
48"	8920 lb	5BB048	8380 lb	5BD048	9340 lb	5BH048	10670 lb	5BJ048	12170 lb	5BN048	-	-	-	-	-	-
54"	7920 lb	5BB054	7445 lb	5BD054	8370 lb	5BH054	9480 lb	5BJ054	10810 lb	5BN054	-	-	-	-	-	-
60"	7120 lb	5BB060	6695 lb	5BD060	7530 lb	5BH060	8520 lb	5BJ060	9730 lb	5BN060	-	-	-	-	-	-
66"	6470 lb	5BB066	6080 lb	5BD066	6840 lb	5BH066	7740 lb	5BJ066	8830 lb	5BN066	-	-	-	-	-	-
72"	5920 lb	5BB072	5570 lb	5BD072	6260 lb	5BH072	7090 lb	5BJ072	8090 lb	5BN072	9560 lb	5BS072	-	-	-	-
78"	5460 lb	5BB078	5135 lb	5BD078	5770 lb	5BH078	6540 lb	5BJ078	7460 lb	5BN078	-	-	10220 lb	5BX078	-	-
84"	5070 lb	5BB084	4760 lb	5BD084	5360 lb	5BH084	6060 lb	5BJ084	6920 lb	5BN084	-	-	9480 lb	5BX084	12650 lb	5BY084
90"	4720 lb	5BB090	4430 lb	5BD090	4990 lb	5BH090	5650 lb	5BJ090	6450 lb	5BN090	7630 lb	5BS090	8840 lb	5BX090	11800 lb	5BY090
96"	4420 lb	5BB096	3990 lb	5BD096	4670 lb	5BH096	5290 lb	5BJ096	6040 lb	5BN096	7190 lb	5BS096	8280 lb	5BX096	11050 lb	5BY096
102"	4160 lb	5BB102	3530 lb	5BD102	4390 lb	5BH102	4980 lb	5BJ102	5680 lb	5BN102	6720 lb	5BS102	7790 lb	5BX102	10390 lb	5BY102
108"	3920 lb	5BB108	3150 lb	5BD108	3990 lb	5BH108	4690 lb	5BJ108	5340 lb	5BN108	6340 lb	5BS108	7350 lb	5BX108	9800 lb	5BY108
114"	3540 lb	5BB114	2830 lb	5BD114	-	-	4440 lb	5BJ114	-	-	-	-	6950 lb	5BX114	9280 lb	5BY114
120"	3190 lb	5BB120	2550 lb	5BD120	3230 lb	5BH120	4130 lb	5BJ120	4810 lb	5BN120	5690 lb	5BS120	6600 lb	5BX120	8800 lb	5BY120
126"	2900 lb	5BB126	2310 lb	5BD126	-	-	-	-	4570 lb	5BN126	5410 lb	5BS126	6270 lb	5BX126	8370 lb	5BY126
132"	2840 lb	5BB132	-	-	-	-	-	-	4410 lb	5BN132	5160 lb	5BS132	5980 lb	5BX132	7980 lb	5BY132
138"	2410 lb	5BB138	-	-	-	-	-	-	4030 lb	5BN138	-	-	5710 lb	5BX138	7620 lb	5BY138
144"	2220 lb	5BB144	-	-	2240 lb	5BH144	-	-	-	-	4740 lb	5BS144	5500 lb	5BX144	7340 lb	5BY144

NOTE: Beam Capacity is reduced if loading is on the step only, unless beams are stabilized by some form of front to back tie.

* Clear span is measured from inside frame to inside frame.

** Capacity of beam pairs in pounds is calculated in compliance with RMI Specifications and AISI Standard. Calculations assume uniform load distribution. Beams of 138" and 144" span require a minimum of two (2) Heavy Duty Cross Bars.

Beam Accessories

Cross Bars 7/8" Step Beams

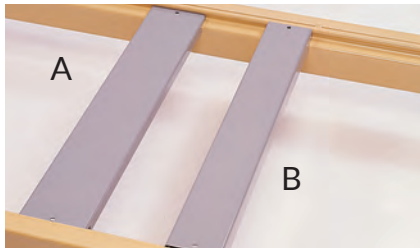

A. - 1/2" Plywood Support

Supports sheets of 1/2" Plywood.

A - 1/2" Plywood Support

Frame Depth	Cat. No.
30"	5AP230C
36"	5AP236C
42"	5AP242C
48"	5AP248C

B. - General Duty Cross Bar

For supporting loads smaller than unit depth.

B - General Duty Cross Bar

Frame Depth	Cat. No.
30"	5AX530C
36"	5AX536C
42"	5AX542C
48"	5AX548C
54"	5AX554C
60"	5AX560C



Coil Bed

Full depth. For proper placement and storage of cylindrical items.

Coil Bed

Frame Depth	Cat. No.
30"	5AC030C
36"	5AC036C
42"	5AC042C
48"	5AC048C

Cross Bars 1-5/8" Step Beams

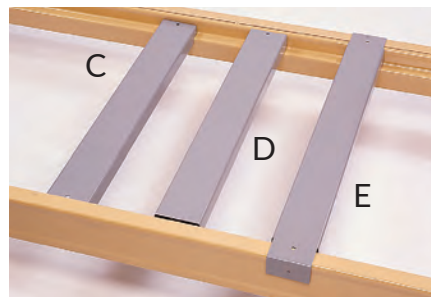

C. - 3/4" Plywood Support

Supports sheets of 3/4" Plywood.

C - 3/4" Plywood Support

Frame Depth	Cat. No.
30"	5AP330
36"	5AP336
42"	5AP342
48"	5AP348
54"	5AP354
60"	5AP360

D. - General Duty Cross Bar

Supports loads smaller than unit depth on 1-5/8" step beams. Not for plywood.

D - General Duty Cross Bar

Frame Depth	Cat. No.
30"	5AX630C
36"	5AX636C
42"	5AX642C
48"	5AX648C
54"	5AX654C
60"	5AX660C

E. - Heavy Duty Flanged Cross Bar

Supports heavier loads smaller than unit depth on 1-5/8" step beams.

E - HD Flanged Cross Bar

Frame Depth	Cat. No.
30"	5AX730C
36"	5AX736C
42"	5AX742C
48"	5AX748C
54"	5AX754C
60"	5AX760C

Fork Clearance Bar and Heavy Duty Skid Channel

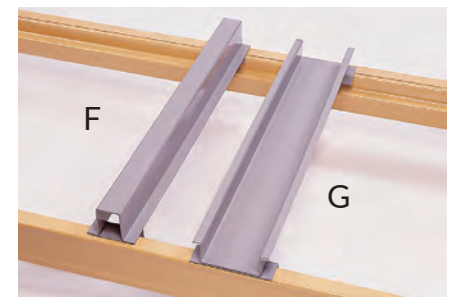

F. - Fork Clearance Bar

Provides proper fork clearance for unpalletized stock, 2" wide by 2-3/4" high.

F - Fork Clearance Bar

Frame Depth	Cat. No.
30"	5AF330C
36"	5AF336C
42"	5AF342C
48"	5AF348C
54"	5AF354C
60"	5AF360C

G. - Heavy Duty Skid Channel Assembly

Provides a channeled base for skid runners, 4" wide by 2" high.

G - HD Skid Channel Assembly

Frame Depth	Cat. No.
30"	5AS230C
36"	5AS236C
42"	5AS242C
48"	5AS248C

H. - Pallet Stop

Attaches to rear beam with Tek screw. Cat. No. 08822 included. For 1-5/8" step beam only. In Pairs. Cat. No. 5AT00H

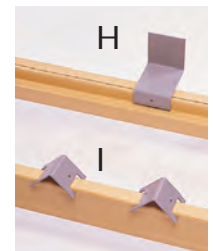

I. - Drum Wedge

Two loose triangular stops for drum storage. Install on front beam only. In Pairs. Cat. No. 5AW000

Pallet Rack Specifications

PALLET RACK: The basic components of Standard Penco Pallet Rack are Upright Frames and Beams. Each is manufactured to exacting tolerances to provide many years of dependable service at their rated loads.

Step Down Design: All beams have a step for the purpose of accepting accessories. Two step sizes are available: 7/8" and 1-5/8" high.

Beam Locking Key For Safety: A unique recessed safety key made from heavy gauge steel engages a slot in the side of the post. As soon as beams are installed, the locking keys should be slid into place. They will resist an upward force from material handling equipment up to 1000 pounds. It is an integral part of the beam assembly, can be engaged easily without tools, and is clearly visible for checking.

Heavy Duty Beam End Connector: Beam ends are made from extra heavy gauge steel. They feature a three prong connection which assures positive beam to post alignment along the 8-1/2" length of the connector, and uniform load distribution. Tabs extend along the face of the beam to provide extra protection to the prongs during transit and installation.

Heavy Duty Beam End Connector (Pallet Rack Plus): Pallet Rack Plus beams are intended for use in severe conditions or high seismic areas and have four pronged end frame connectors. The beams are centered along the 11 1/2" long connector so all prongs share equally in the live beam load. Any Penco pallet rack beam can be equipped with four-pronged connectors.

Welded Upright Frame Bracing: Upright frame columns are securely MIG welded together with channel type braces for maximum rigidity.

Upright Column: A continuous post roll formed into an "M" design for added strength. Slanted slots on the column allow for beam placement on 3" vertical centers. The greater the unit load the tighter the beam-upright connection becomes. Slots on column sides accept the safety beam locking key. The design allows for standard beams to be placed flush with the top, or as close as 9" from the floor.

Upright Column (Pallet Rack Plus): A continuous post roll formed into an "M" design for added strength. Slanted slots on the column allow for beam placement on 3" vertical centers. The greater the unit load the tighter the beam-upright connection becomes. All Plus pallet rack beams are attached 3" down from the top of the heavy duty connector and cannot be installed flush with the top of the uprights. Plus beams can be placed within 9" above the floor.

Foot Plate: A heavy gauge foot plate is securely welded to each post to provide load distribution over 13.7 square inches, and two 9/16" holes allow for floor anchoring on either side of the frame. Standard duty foot-plates are 7 ga. thick.

Foot Plate (Pallet Rack Plus): All pallet rack Plus upright frames have foot-plates that are 35 square inches and 3/8" thick. Four 9/16" holes are present at the corners for anchoring.

Pallet Rack Frames: Penco Pallet Rack Upright Frames are available in five different load carrying ranges. A letter code stamped into the face of the post indicates the frame type. Depths of 30", 36", 42", 48", 54" and 60" are standard, but other depths are available. Standard heights range from 48" to 240" in 6" increments, but greater heights can be achieved when splices are used. Double posted and cantilever leg custom upright configurations are available upon request. Beam heights adjust on 3" vertical centers, and are independent on each side of the frame. Various load rated frames can be combined in a row of rack for maximum economy. Beams cannot be placed at locations where a splice is positioned. Penco Pallet Rack Upright

Frames are furnished completely fabricated, welded into rigid units. Standard finish for upright frames is 028 Gray baked enamel. Other standard Penco colors are available upon request.

We recommend that all upright frames be securely anchored to the floor for safety. Seismic conditions and local codes may require anchors other than the Penco 1/2"-13 x 3 3/4" wedge anchor be used. We suggest you check with local code officials about anchoring as many jurisdictions have approved different anchors.

Pallet Rack Beams: Penco has engineered its roll-formed one piece beam to achieve the highest possible strength-to-weight ratios in the most frequently desired load ratings through the use of efficient design and high strength steel. Beams are offered in eight basic styles with different vertical profiles and steel gauges. Beam step heights of 7/8" and 1-5/8" are available for a wide variety of accessory use. Both the overlapping seam and the beam end connector are securely MIG welded for strength. The face of the beam has an M-design recessed configuration for added strength, protecting the locking key, and to accept pressure sensitive labeling. Each beam is stamped with an identifying letter referring to the load bearing capacity. Beams are finished in 710 Sagebrush Yellow baked enamel for high visibility. Safety Yellow and any other standard Penco colors are available upon request.

PALLET RACK ACCESSORIES

Plywood Supports: For supporting plywood or other wood decking. Styles are available for 1/2" deck on 7/8" step beams and 3/4" deck on 1-5/8" step beams.

General Duty Cross Bars: For supporting loads smaller than unit depth.

Heavy Duty Flanged Cross Bar: Supports heavier loads smaller than unit depth on 1-5/8" step beams.

Fork Clearance Bar: Provides proper fork clearance for unpalletized stock, 2" wide by 2-3/4" high.

Heavy Duty Skid Channel Assembly: Provides a channeled base for skid runners, 4" wide by 2" high.

Frame Splice: For adding to height of existing frame. Can be supplied welded in top of new frame if specified on order. (Top frame must be ordered without foot plate.) Hardware provided.

Frame Protector: Anchors to floor at front of post. Provides protection against damage from material handling equipment.

Frame Deflector: Fastens to front of upright post on 3" increments.

Rigid Wall Bracket: Structurally connects racks to wall for additional stability. Frame hardware included.

Rigid Row Spacer: Structurally connects and spaces two rows of rack back-to-back to satisfy NFPA requirements. Bolted into place. Hardware included.

Reel Holder: Accessorizes rack for elevated reel storage. Capacity is 1,000 lbs./pair and they can hold axels up to 2 1/2" diameter. Hardware included.

Decking: Decking for Pallet Rack is available in a number of formats that include wire, steel and wood.

PENCO RESERVES THE RIGHT TO VARY SPECIFICATIONS CONSISTENT WITH A POLICY OF CONTINUOUS PRODUCT IMPROVEMENT.

Pallet Rack Plus Specifications

PALLET RACK PLUS: The basic components of Penco Pallet Rack Plus are Upright Frames and Beams. Each is manufactured to exacting tolerances to provide many years of dependable service at their rated loads. Other components and accessories are available

Step Down Design: All beams have a step for the purpose of accepting accessories. Two step sizes are available: 7/8" and 1-5/8" high.

Beam Locking Key for Safety: A unique recessed safety key installed into each beam connector that is made from heavy gauge steel engages a slot in the side of the post. As soon as beams are installed, the locking key should be slid into place. They will resist an upward force from material handling equipment up to 1000 pounds. It is an integral part of the beam assembly, can be engaged easily without tools, and is clearly visible for checking.

Heavy Duty Beam End Connector: Pallet Rack Plus beams are intended for use in severe conditions or high seismic areas and have four pronged end frame connectors. The beams are centered along the 11 1/2" long connector so all prongs share equally in the live beam load. Any Penco pallet rack beam can be equipped with four-pronged connectors.

Welded Upright Frame Bracing: Upright frame columns are securely MIG welded together with channel type braces for maximum rigidity.

Upright Column: A continuous post roll formed into an "M" design for added strength. Slanted slots on the column allow for beam placement on 3" vertical centers. The greater the unit load the tighter the beam-upright connection becomes. All Plus pallet rack beams are attached 3" down from the top of the heavy duty connector and cannot be installed flush with the top of the uprights. Plus beams can be placed within 9" above the floor.

Foot Plate: All pallet rack Plus upright frames have footplates that are 35 square inches and 3/8" thick. Four 9/16" holes are present at the corners for anchoring.

PALLET RACK FRAMES: Penco Pallet Rack Plus Upright Frames are available in five different load carrying ranges. A letter code stamped into the face of the post indicates the frame type. Depths of 30", 36", 42", 48", 54" and 60" are standard, but other depths are available. Standard heights range from 48" to 240" in 6" increments, but greater heights can be achieved when upright frames are spliced together. Double posted and Cantilever leg custom upright configurations are available upon request. Beam heights adjust on 3" vertical centers, and are independent on each side of the frame. Various load rated frames can be combined in a row of rack for maximum economy. Beams cannot be placed at locations where a splice is positioned. Penco Pallet Rack Upright Frames are furnished completely fabricated, welded into rigid units. Standard finish for upright frames is 028 Gray baked powdercoat enamel. Other standard Penco colors are available upon request. We recommend that all upright frames be securely anchored to the floor. Seismic conditions and local codes may require anchors other than the Penco 1/2"-13 x 3 3/4" wedge anchor be used. We suggest you check with local code officials about anchoring as many jurisdictions have approved different anchors.

PALLET RACK BEAMS: Penco has engineered its roll-formed one piece beam to achieve the highest possible strength-to-weight ratios in the most frequently desired load ratings through the use of efficient design and high strength steel. Beams are offered in eight basic styles with different vertical profiles and steel gauges. Beam step heights of 7/8" and 1-5/8" are available for a wide variety of accessory use. Both the overlapping seam and the beam end connector are securely MIG welded for strength. The face of the beam has an M-design recessed configuration for added strength, protecting the locking key, and to accept pressure sensitive labeling. Each beam is stamped with an identifying letter referring to the load bearing capacity. Beams are finished in 710 Sagebrush Yellow baked enamel for high visibility. Safety Yellow and any other standard Penco colors are available upon request.

PALLET RACK ACCESSORIES

Plywood Supports: For supporting plywood or other wood decking. Styles are available for 1/2" deck on 7/8" step beams and 3/4" deck on 1-5/8" step beams.

General Duty Cross Bars: For supporting loads smaller than unit depth.

Heavy Duty Flanged Cross Bars: Supports heavier loads smaller than upright end frame depth. Only available for use with 1-5/8" step beams.

Fork Clearance Bar: Provides proper fork clearance for loads not on pallets. Fork clearance bars are 2" wide by 2-3/4" high.

Heavy Duty Skid Channel Assembly: Provides a channeled base for skid runners, 4" wide by 2" high.

Frame Splice: For adding to height of existing frame. Can be supplied welded in top of new frame if specified on order. (Top frame must be ordered without foot plate.) With hardware. Can be used with standard or Plus uprights. Length of splice allows for two bolt locations on each side of the splice joint. Hardware for attachment is included. Top frames must be ordered without footplates.

Frame Protector: Anchors to floor at front of post. Provides protection against damage from material handling vehicles.

Frame Deflector: Fastens to front upright post on 3" increments.

Rigid Wall Bracket: Structurally connects racks to wall for additional stability. Frame hardware included.

Rigid Row Spacer: Structurally connects and spaces two rows of rack back-to-back to satisfy NFPA requirements. Bolted type. Hardware included.

Reel Holder: Accessorizes pallet rack for elevated reel storage. Capacity is 1,000 lbs/pair and they can hold axles up to 2 1/2" diameter. Hardware is included.

Decking: Decking for pallet rack is available in a number of formats that include wire, steel and wood.

Stairs and Stair Towers

Stairs and Stair Towers (Please contact your District Manager)



Penco offers a wide range of pre-designed stairs based on the height of existing decks. Penco also specializes in designing custom stairs, landings and gates. Industrial stairs and stair towers are available with either open-riser or closed-riser designs, in welded or bolted construction, with stair treads offered in either open grate or diamond plate material.

Stair towers are used to access multi-level structures. Unlike individual stairs that are incorporated with rack and shelving systems, often stairs are required to be independent of the system, Stair towers are a self-supported structures that have multiple levels to exit onto the rack modules.

Stairs are constructed of heavy duty MC10 x 8.4# structural channel. Deck heights over 12 ft. require an additional intermediate landing.



Ladders / Handrails



Ladders (Contact your District Manager)

Vertical ladders are available with and without cages. Ladders over 20' require a cage by code. Ladders are used to access mezzanines/work platforms as a secondary access, catwalks, maintenance areas or as roof access for single level office buildings.

Handrail (Contact your District Manager)

Standard handrail is fabricated from 1½" x 14 gauge square steel tube and can be fabricated to meet any project specifications. The standard color is safety yellow but handrails are available in any of Schmidt's 24 standard colors. Handrails are sold per lineal foot price and can be cut to size in the field. Handrail is also available in 1¼" schedule 40 pipe.



Overview

Penco has been building lockers for over 150 years that last for decades and have become part of the fabric of American life. Look in any school and chances are you'll find Penco's lockers in the athletic department, field house, faculty break room and of course, lining the corridors.

School lockers may be Penco's foundation, but the spectrum of products doesn't end there. Penco has locker solutions for recreation centers, health clubs, hospitals, back office and industry break rooms, while at the same time delivering the widest range of solutions to serve first responders in the military, law enforcement and fire and rescue profession.

For locker specifications, see page 92-104.

Terms Used in This Catalog

KD: Knocked Down, or lockers that are shipped unassembled for assembly and installation at their destination.

W: Welded, or lockers that are shipped assembled for installation at their destination.

GA: Gauge of steel - indicates the thickness. The lower the number the thicker the steel.

LH & RH: Left Hand and Right Hand side of a locker, as seen standing in front of a locker.

Tier: A "level" of a locker defined by the number of doors in a vertical row. This can range from 1 to 9 tiers.

Opening & Frame: Opening is what is behind a door. A frame is the unit that holds the doors. There can be multiple doors per frame.

Double Row: "Back-to-back" lockers.

Double Door Locker: A locker with two full length doors that open in the center.

W, D & H: Width, Depth & Height dimensions (inches).

CCBP: Common Color Body Parts (Vanguard and Guardian only): Backs, tops, bottoms, sides, & shelves all come in 073 Champagne as standard. Full color available upon special order at an additional cost.



NOTE: Welded Gen2, Stadium and Patriot lockers are not shown above.

Ventilation Options

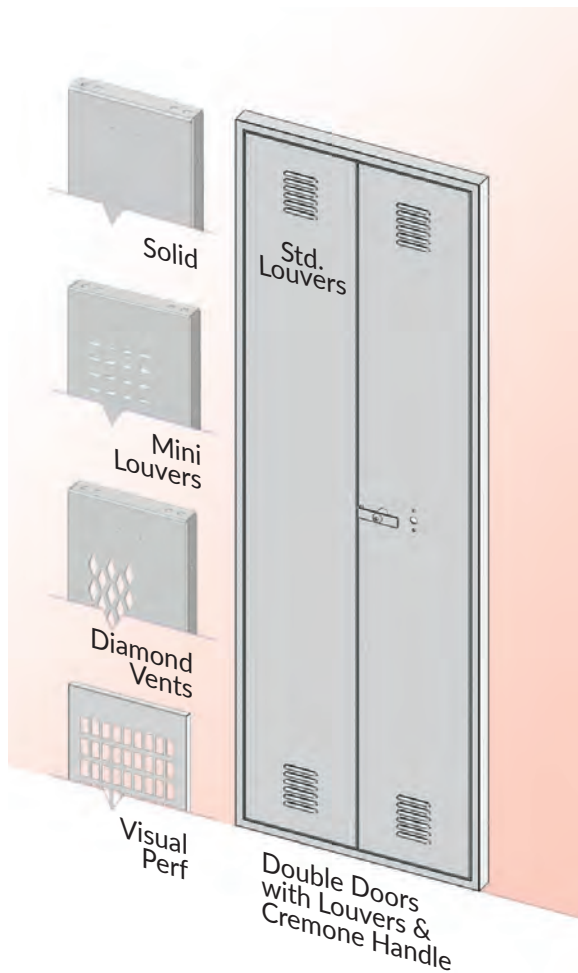

Cremone Multi-Point Handle

Available on Guardian Plus, Invincible II, and Welded Gen2 ONLY

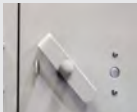

An unbreakable steel handle securely bolted to a 3-point latching system.

A 3/8" diameter latching rod engages at the top and bottom of the door frame. A 1/8" thick center latch locks the center of the door to the frame. The Cremone Handle is available on a variety of KD and welded heavy duty locker doors.

3 views below: top, middle, and bottom of inside of door with Cremone Handle.

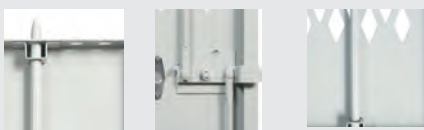

Handles & Latching



Die-Cast Handle. This patented die-cast handle opens multi-point latch lockers with one simple motion. Standard on 1, 2 & 3 tier, 2-Person and Duplex Vanguard lockers.



Automatic Multi-Point Latching. Allows the door to be closed without locking. Standard on all multi-point doors except box lockers, Single Point Latch doors and Cremone Handle lockers.

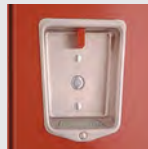

Classic III Stainless Steel Recessed Handle. Seamless deep drawn design is attractive as well as strong. Utilizes the Automatic Multi-Point Latching feature.

Standard on all 1, 2 & 3 tier 2-Person and Duplex, Vanguard Recessed, Guardian & Guardian PLUS lockers. Also standard on Invincible II and Welded Gen2 1, 2 and 3 tier lockers. This is the preferred handle for ADA lockers.



Defiant II Single Point Latch. Stainless steel deep drawn pocket with no moving parts (single point latch). Used with a vertical or horizontal pan welded to door. Standard on 1, 2 and 3 tier Defiant II Locker models.



Anti Pry Lug. Defeats prying attempts by capturing the door flange and preventing separation from the door channel.

See Defiant II details on page 98.

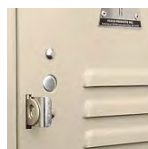

Friction Catch Door Pull.

All box lockers come standard with this friction catch door pull handle with padlock hasp.

Vanguard™

At a Glance

- Knocked down construction
- Standard louvers for ventilation
- Classic III handle standard on QuickShip multi-point latch models
- 24 ga. body in CCBP or full color at additional cost
- Many sizes available through QuickShip

Ventilation Options



Standard Louvers (S) Mini Louvers (O) Solid Door (O) Visual Perf (O)

Door Handle Options

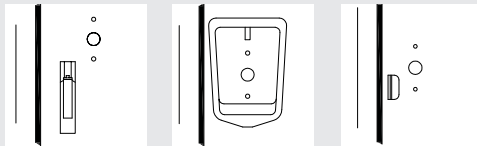

Die-Cast (S) Classic III Recessed (S) Friction Catch (SB)

S = Standard O = Optional* SB = Standard on Box Lockers
*additional charges may apply

For Vanguard specifications, see page 94.

Penco has been manufacturing lockers for decades that last for decades, and the Vanguard line is the embodiment of what it takes to withstand the typical daily use and abuse.

The powder coat baked enamel finish is tough and available in all standard colors. For quieter operation, each frame features multiple noise reducing rubber bumpers.

The welded door frames have mortise and tenon construction and are spot welded for lifetime rigidity. Every door has a continuous door strike. All hinges are full loop, 5-knuckle design.

Note that different types of handles are available on many Vanguard lockers and that 3-tier Vanguard lockers have 3 handle choices. Additional specialty Vanguard models are shown on page 54. Also, many popular Vanguard lockers are available in our QuickShip program with a limited color selection as shown on page 55.

CCBP: Common Color Body Parts (Vanguard and Guardian only): Backs, tops, bottoms, sides, & shelves all come in 073 Champagne as standard. Full color available upon special order at an additional cost. (This excludes Vanguard Duplex, Dual, 2, 7, 8, & 16-person, Wall Mount, Executive, Galvaneal, Double Door, & Box Over lockers).

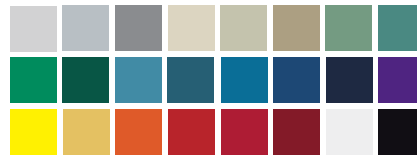

Chart of 24 Brilliant Colors
See Page 117

With Classic III Recessed Pocket Handles



With Vanguard Cast Pull-out Handles



With Box Locker Friction Catch Door Pull Handles



Sizes and Dimensions

Vanguard 1, 2 & 3 Tier Lockers																	
		1 Tier						2 Tier						3 Tier			
Overall Height*		60"	72"	84"	60"	72"	84"	60"	72"	84"	60"	72"	84"	60"	72"	60"	72"
Opening Height*		60"	72"	42"	60"	72"	42"	30"	36"	42"	30"	36"	42"	20"	24"	20"	24"
Width	Depth	Die-Cast Handle			Classic III Handle			Die-Cast Handle			Classic III Handle			Die-Cast Handle		Classic III Handle	
9"	12"	6101V	6151V	-	6101R	6151R	-	6201V	6221V	-	6201R	6221R	-	6401V	6413V	6401R	6413R
	15"	6103V	6153V	-	6103R	6153R	-	6203V	6223V	-	6203R	6223R	-	6403V	6415V	6403R	6415R
	18"	6105V	6155V	-	6105R	6155R	-	6205V	6225V	-	6205R	6225R	-	6405V	6417V	6405R	6417R
12"	12"	6111V	6161V	6013V	6111R	6161R	6013R	6211V	6231V	6251V	6211R	6231R	6251R	6407V	6419V	6407R	6419R
	15"	6113V	6163V	6014V	6113R	6163R	6014R	6213V	6233V	6253V	6213R	6233R	6253R	6409V	6421V	6409R	6421R
	18"	6115V	6165V	6015V	6115R	6165R	6015R	6215V	6235V	6255V	6215R	6235R	6255R	6411V	6423V	6411R	6423R
	21"	6117V	6167V	-	6117R	6167R	-	6217V	6218V	-	6217R	6218R	-	6449V	6499V	6449R	6499R
	24"	6118V	6168V	-	6118R	6168R	-	6200V	6220V	-	6200R	6220R	-	-	-	-	-
15"	12"	6119V	6179V	6016V	6119R	6169R	6016R	6227V	6239V	6073V	6227R	6239R	6073R	-	6472V	-	6472R
	15"	6121V	6171V	6017V	6121R	6171R	6017R	6229V	6241V	6261V	6229R	6241R	6261R	-	6494V	6436R	6494R
	18"	6123V	6173V	6018V	6123R	6173R	6018R	6237V	6243V	6263V	6237R	6243R	6263R	-	6496V	-	6496R
	21"	6125V	6175V	-	6125R	6175R	-	6257V	6245V	-	6257R	6245R	-	-	-	-	-
	24"	6126V	6177V	-	6126R	6177R	-	6258V	6246V	-	-	6246R	-	-	-	-	-
18"	15"	6134V	6180V	-	6134R	6180R	-	-	6259V	-	-	6259R	-	-	-	-	-
	18"	6131V	6181V	-	6131R	6181R	-	-	6247V	-	-	6247R	-	-	-	-	6335R
	21"	6133V	6183V	-	6133R	6183R	-	-	6249V	-	-	6249R	-	-	-	-	-
	24"	6135V	6185V	-	6135R	6185R	-	-	6250V	-	-	6250R	-	-	-	-	-
24"	18"	6149V	6196V	-	6149R	6196R	-	-	-	-	-	-	-	-	-	-	-
	21"	6158V	6198V	-	6158R	6198R	-	-	-	-	-	-	-	-	-	-	-
	24"	6160V	6199V	-	6160R	6199R	-	-	6274V	-	-	6274R	-	-	-	-	-

Vanguard 2 Person and Duplex Lockers									
		2 Person				Duplex			
Overall Height*		60"	72"	60"	72"	60"	72"	60"	72"
Unit Width	Unit Depth	Die-Cast Handle		Classic III Handle		Die-Cast Handle		Classic III Handle	
15"	12"	6510V	6500V	6510R	6500R	-	-	-	-
	15"	6506V	6501V	6506R	6501R	6519V	6531V	6519R	6531R
	18"	6437V	6503V	6437R	6503R	6521V	6533V	6521R	6533R
	21"	-	6505V	-	6505R	-	6535V	-	6535R
18"	15"	-	6509V	-	6509R	-	-	-	-
	18"	-	6515V	-	6515R	-	-	-	-
	21"	-	6525V	-	6525R	-	-	-	-

Vanguard Box Lockers - 3, 4, 5 & 6 Tier								
		3 Tier		4 Tier		5 Tier		6 Tier
Overall Ht.*		60"	72"	60"	72"	60"	72"	72"
Opening Ht.*		20"	24"	15"	18"	12"	14-2/5"	12"
Unit Width	Unit Depth	Cat. No.	Cat. No.	Cat. No.	Cat. No.	Cat. No.	Cat. No.	Cat. No.
9"	12"	6301V	6313V	-	-	-	-	-
	15"	6303V	6315V	-	-	-	-	-
	18"	6305V	6317V	-	-	-	-	-
12"	12"	6307V	6319V	6325V	6331V	6343V	6353V	6365V
	15"	6309V	6321V	6327V	6337V	6345V	6355V	6367V
	18"	6311V	6323V	6329V	6339V	6347V	6357V	6369V
	21"	6349V	6399V	6393V	6395V	-	6435V	6371V
15"	12"	-	6372V	-	-	-	-	6363V
	15"	-	6394V	6333V	6431V	6351V	6359V	6373V
	18"	-	6396V	-	6433V	6397V	6361V	6375V
	21"	-	-	-	-	-	-	6377V
18"	18"	-	6335V	-	-	-	-	6379V
	21"	-	-	-	-	-	-	6378V

* All dimensions are in inches. Overall Height is the overall height of the locker frame, NOT including legs. Opening Height is the nominal height of the individual door opening. Opening Height for 2 Person Lockers: for 60" high models, bottom doors are nominal 42" high; for 72" high models, bottom doors are nominal 54" high. Book compartment doors are nominal 9" high each.

Specialty Lockers



Dual Lockers

A dual locker is a single tier locker with a vertical partition separating the area beneath the shelf into two compartments. It is ideally suited for situations where street clothes and work clothes are to be kept apart. It is generally used with lockers 15" or 18" wide and 18" or 21" deep. Guardian and

Invincible II lockers can also be supplied as dual lockers.



The Executive

The Executive is a custom-outfitted 24" wide double door locker which offers such optional personal amenities as multiple storage shelves, lockable inner storage compartment, and combination comb & brush tray with towel bar. Shown

here with the available Classic III stainless steel recessed handle and optional front and end bases. Note that the depth of shelves and partitions are 3" less than the locker depth.

It is especially appropriate for golf clubs. Other accessories available include golf ball tray, acrylic mirror and name card holder. For ordering information contact your Penco representative.

Optional Accessories



Comb & Brush Tray with Towel Bar



Card Holder



Inner storage compartment and golf ball tray

16 Person Locker

Accommodates 16 users in only 69" of floor space. Includes a 45" wide coat rod. Ideal for employee lockers. Accepts built-in locks or padlocks.

69"W x 18" D x 72"H. Cat. No. 6579V



Wall Mounted Locker with Coat Rod



A practical storage unit where space is at a premium. Four private compartments with a hanging area for 16 coats. When wall mounted, the floor below is kept clear for easy cleaning (wall anchors are not included). Can also be set on counters or cabinets (without coat rod).

45"W x 18"D x 13-5/8" H.

Cat. No. 68242



One High Box Locker

This 12" wide individual one high box locker provides storage for personal

items and features standard box locker construction with friction catch door pull. Actual overall height is 13-5/8".

Half Height Locker, 1 Tier



Available in 30-1/2", 36-1/2" and 48-1/2" heights; Available in 12", 15" and 18" depths; 12" wide. Only 48-1/2" high lockers include a shelf for storage of books and small articles.



Box Over Lockers

Provides a compact independent lockable door above a 60" high standard Vanguard Door. If a shelf is required in the lower compartment, it must be ordered separately.

Box Over Lockers - 72" High

Unit Width	Unit Depth	Cat. No.
12"	12"	6439V
12"	15"	6441V
12"	18"	6443V
15"	15"	6436V
18"	18"	6445V
18"	21"	6447V

7 and 8 Person Lockers



These efficient lockers are ideal for multiple user situations such as school gymnasium locker rooms. The box compartments (18"W x 12"H) are for permanent storage of athletic gear. When a user is present, the large locker (18"W x 60"H) is used for street clothes.

7 Person Locker

Unit Width	Unit Depth	Unit Height	Cat. No.
36"	18"	72"	6573V
36"	21"	72"	6575V

8 Person Locker



Unit Width	Unit Depth	Unit Height	Cat. No.
54"	18"	72"	6577V

QuickShip Lockers



Lockers in 5 working days

- KD lockers ship in 72 hours
- Many QuickShip accessories are available (see next pages)
- 1, 2 & 3 Tier models have Recessed Handles
- Assembly available by request
- 6" Legs standard (available with no legs by request)
- Number plates included
- 1, 2 and 3-Wide groupings

QuickShip Vanguard 1 Tier

Grp.	Illustration	Width	Depth	Opn.Ht.*	028 Gray	073 Champagne
1-Wide		12"	12"	60"	68001R028	68001R073
		12"	15"	60"	68011R028	68011R073
		12"	18"	60"	68021R028	68021R073
		12"	12"	72"	68051R028	68051R073
		12"	15"	72"	68061R028	68061R073
		12"	18"	72"	68071R028	68071R073
		15"	18"	72"	68091R028	68091R073
		18"	18"	72"	68101R028	68101R073
2-Wide		12"	12"	60"	68002R028	68002R073
		12"	15"	60"	68012R028	68012R073
		12"	18"	60"	68022R028	68022R073
		12"	12"	72"	68052R028	68052R073
		12"	15"	72"	68062R028	68062R073
		12"	18"	72"	68072R028	68072R073
		15"	18"	72"	68092R028	68092R073
		18"	18"	72"	68102R028	68103R073
3-Wide		12"	12"	60"	68003R028	68003R073
		12"	15"	60"	68013R028	68013R073
		12"	18"	60"	68023R028	68023R073
		12"	12"	72"	68053R028	68053R073
		12"	15"	72"	68063R028	68063R073
		12"	18"	72"	68073R028	68073R073
		15"	18"	72"	68093R028	68093R073
		18"	18"	72"	68103R028	68103R073

QuickShip Vanguard 2 Tier

Grp.	Illustration	Width	Depth	Opn.Ht.*	028 Gray	073 Champagne
1-Wide		12"	12"	30"	68111R028	68111R073
		12"	15"	30"	68031R028	68031R073
		12"	18"	30"	68041R028	68041R073
		12"	12"	36"	68121R028	68121R073
		12"	15"	36"	68131R028	68131R073
		12"	18"	36"	68141R028	68141R073
		15"	18"	36"	68261R028	68261R073
2-Wide		12"	12"	30"	68112R028	68112R073
		12"	15"	30"	68032R028	68032R073
		12"	18"	30"	68042R028	68042R073
		12"	12"	36"	68122R028	68122R073
		12"	15"	36"	68132R028	68132R073
		12"	18"	36"	68142R028	68142R073
		15"	18"	36"	68262R028	68262R073
3-Wide		12"	12"	30"	68113R028	68113R073
		12"	15"	30"	68033R028	68033R073
		12"	18"	30"	68043R028	68043R073
		12"	12"	36"	68123R028	68123R073
		12"	15"	36"	68133R028	68133R073
		12"	18"	36"	68143R028	68143R073
		15"	18"	36"	68263R028	68263R073

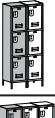

QuickShip Vanguard 3 Tier

Grp.	Illustration	Width	Depth	Opn.Ht.*	028 Gray	073 Champagne
1-Wide		12"	12"	24"	68331R028	68331R073
		12"	15"	24"	68341R028	68341R073
		12"	18"	24"	68351R028	68351R073
2-Wide		12"	12"	24"	68332R028	68332R073
		12"	15"	24"	68342R028	68342R073
		12"	18"	24"	68352R028	68352R073
3-Wide		12"	12"	24"	68333R028	68333R073
		12"	15"	24"	68343R028	68343R073
		12"	18"	24"	68353R028	68353R073



QuickShip Vanguard 5 Tier

Grp.	Illustration	Width	Depth	Opn.Ht.*	028 Gray	073 Champagne
1-Wide		12"	12"	12"	68161X028	68161X073
		12"	15"	12"	68171X028	68171X073
2-Wide		12"	12"	12"	68162X028	68162X073
		12"	15"	12"	68172X028	68172X073
3-Wide		12"	12"	12"	68163X028	68163X073
		12"	15"	12"	68173X028	68173X073

QuickShip Vanguard 6 Tier

Grp.	Illustration	Width	Depth	Opn.Ht.*	028 Gray	073 Champagne
1-Wide		12"	12"	12"	68191X028	68191X073
		12"	15"	12"	68201X028	68201X073
		12"	18"	12"	68211X028	68211X073
2-Wide		12"	12"	12"	68192X028	68192X073
		12"	15"	12"	68202X028	68202X073
		12"	18"	12"	68212X028	68212X073
3-Wide		12"	12"	12"	68193X028	68193X073
		12"	15"	12"	68203X028	68203X073
		12"	18"	12"	68213X028	68213X073

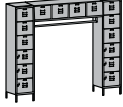
QuickShip Vanguard Specialty Lockers

16 Person						
Illustration	Width	Depth	Frame Ht.*	028 Gray	073 Champagne	
	69"	18"	72"	68231X028	68231X073	
Wall Mount						
	45"	18"	13-5/8"	68242X028	68242X073	

* Height shown is the nominal opening height for 1 through 6 tier, and overall frame height for others, not including 6" legs which are standard on all except the Wall Mount Locker. Width is the nominal outside dimension for 1 frame.

** Shaded area in illustrations indicates the unit of sale; i.e. Cat. No. 68003R028 is for one frame of a 12" x 12" x 60" 1 tier locker, but since it is packaged in a group of 3, it must be ordered in multiples of 3.

***These are FULL COLOR lockers (not CCBP).

QuickShip Locker Accessories

QuickShip Slope Top Kits

1- Wide



Width	Depth	Height	028 Gray	073 Champagne
12"	12"	4"	60229H028	60229H073
12"	15"	5"	60231H028	60231H073
12"	18"	6"	60233H028	60233H073
15"	18"	6"	60239H028	60239H073
18"	18"	6"	60243H028	60243H073

3-Wide



12"	12"	4"	60230H028	60230H073
12"	15"	5"	60232H028	60232H073
12"	18"	6"	60234H028	60234H073
15"	18"	6"	60240H028	60240H073
18"	18"	6"	60244H028	60244H073

QuickShip Slope Top Fillers

Slope Top Fillers

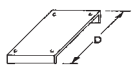

15"	12"	-	661371-028	661371-073
15"	15"	-	661372-028	661372-073
15"	18"	-	661373-028	661373-073

Slope Top Corner Fillers

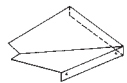

12"	12"	-	66100-028	66100-073
15"	15"	-	66101-028	66101-073
18"	18"	-	66102-028	66102-073

QuickShip Hoods

Slope Hood (18 Ga.)



72"	12"	5"	66144H028	66144H073
72"	15"	6"	66147H028	66147H073
72"	18"	7"	66150H028	66150H073

Hood Splice



-	12"	-	66168-028	66168-073
-	15"	-	66169-028	66169-073
-	18"	-	66170-028	66170-073

Left Hand Slope End



-	12"	-	66158H028	66158H073
-	15"	-	66160H028	66160H073
-	18"	-	66162H028	66162H073

Right Hand Slope End

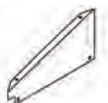

-	12"	-	66159H028	66159H073
-	15"	-	66161H028	66161H073
-	18"	-	66163H028	66163H073

Universal Hood Support



-	-	-	66070	-
---	---	---	-------	---

QuickShip Locker Bases, 6" High (for lockers with 6" Legs)

Front Bases

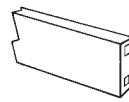

Width	Depth	Height	028 Gray	073 Champagne
12"	-	6"	60217-028	60217-073
15"	-	6"	60218-028	60218-073
18"	-	6"	60219-028	60219-073

End Bases

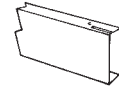

-	12"	6"	60204-028	60204-073
-	15"	6"	60205-028	60205-073
-	18"	6"	60206-028	60206-073

QuickShip Flat Top Fillers

Flat Top Fillers (Overlaps Standard Tops)

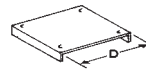

15"	12"	-	661321C028	661321C073
15"	15"	-	661322C028	661322C073
15"	18"	-	661323C028	661323C073

Flat Top Corner Fillers

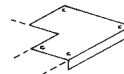

12"	12"	-	66138-028	66138-073
15"	15"	-	66139-028	66139-073
18"	18"	-	66140-028	66140-073

Flat Top Exposed Ends/Divisions (16 Ga.)

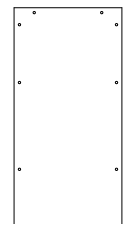

-	12"	60"	601660-028	601660-073
-	15"	60"	601670-028	601670-073
-	18"	60"	601680-028	601680-073
-	12"	72"	601760-028	601760-073
-	15"	72"	601790-028	601790-073
-	18"	72"	601800-028	601800-073

Hardware Kit - Locker Groupings

Description

Cat.No.

Hardware kit to join locker grouping together - 100 - 1/2" bolts and 100 - nuts

8633/72-Hkit

QuickShip Fillers

Vertical Angles

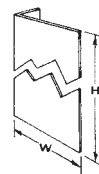

Width	Depth	Height	028 Gray	073 Champagne
12"	-	60"	66113-028	66113-073
12"	-	66"	661221-028	661221-073
12"	-	72"	661141-028	661141-073
12"	-	78"	66116-028	66116-073

Wall Angles (Slip Joint)



-	-	60"	66118-028	66118-073
-	-	66"	66120-028	66120-073
-	-	72"	66119-028	66119-073
-	-	78"	66121-028	66121-073

Touch Up Spray Paint - 12 oz.

Must be ordered with lockers, shelving, or RivetRite products.

723 Light Putty	028 Gray	073 Champagne
97723Z	97028Z	97073Z



QuickShip Locker Accessories

QuickShip Zee Bases For Lockers without Legs

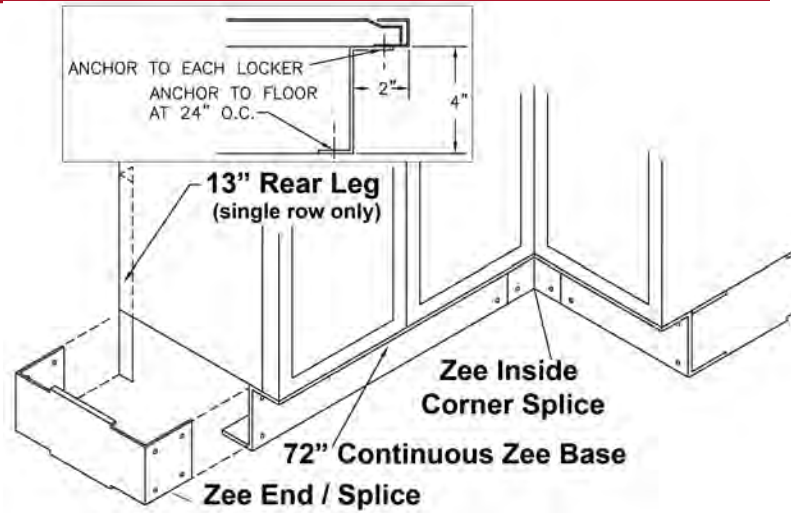

See illustration at right	Width	Depth	Height	028 Gray	073 Champagne	
	Front Zee Base (14 Ga.)					
	72"	-	4"	66700H028	66700H073	
	Splice/End Base					
	-	12"	4"	66701H028	66701H028	
	-	15"	4"	66702H028	66702H028	
	-	18"	4"	66703H028	66703H028	
	Zee Inside Corner Splice					
	-	-	4"	66709H028	66709H073	
	Rear Leg (for use with 4" high Zee Base)					
-	-	13"	60092-028	60092-073		

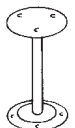
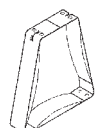
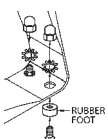

QuickShip Locker Room Benches & Accessories

	Width	Depth	Height	Cat. No.	Description
Hardwood Bench Tops					
	36"	9-1/2"	1-1/4"	9611	Finished with clear lacquer. Use 2 pedestals per bench through 96".
	48"	9-1/2"	1-1/4"	9600	
	72"	9-1/2"	1-1/4"	9602	
	96"	9-1/2"	1-1/4"	9604	
Steel Tube Heavy Duty Pedestals					
	028 Gray	16-1/4"	60822H028	Includes hardware to mount to bench. Pedestal must be anchored to floor for safety - see concrete floor anchor.	
	073 Champagne	16-1/4"	60822H073		
Stainless Steel Pedestal					
	-	16-1/4"	60827H	Includes hardware to fasten to bench. See non-skid kit below.	
Non-Skid Pedestal Kit for Stainless Pedestal					
	-	-	68420	Set of 4 rubber feet and hardware for Stainless Steel Pedestals. Order 1 set per pedestal.	
Concrete Floor Anchor 1/4" Diameter					
	-	2"	9680		

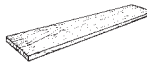
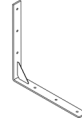
ADA Benches/Bracket/Shelves/Logo

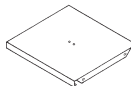
	Width	Depth	Height	Cat. No.	Description
Hardwood Benches for ADA Applications					
	42"	18"	1-1/4"	9625	These benches are used with the Bench Bracket (below).
	42"	24"	1-1/4"	9624	
	48"	18"	1-1/4"	9628	
	48"	24"	1-1/4"	9623	
Bench Bracket for ADA Bench					
	Width	Depth	Height	028 Gray	073 Champagne
	-	20"	20"	6ACXHP61H028	6ACXHP61H073
To provide back support with 18" bench and 24" seat.					
ADA Logo Label					
	-	-	-	8690	
Locker Shelves for ADA Applications					
	Width	Depth	Height	028 Gray	073 Champagne
	12"	12"	-	60400-028	60400-073
	12"	15"	-	60402-028	60402-073
	12"	18"	-	60404-028	60404-073
	15"	18"	-	60408-028	60408-073
	18"	18"	-	60412-028	60412-073
Extra shelves must be installed in the field - may require drilling.					

QuickShip Locks

	Description	Cat.No.
	Dead Bolt, Flat Key Lock	9617
	Master Key for Dead Bolt Flat Key Lock	96171

At a Glance

- Knocked down construction
- Standard solid 16 ga. door and Classic III handle
- 14 ga. door available
- Optional Defiant II single point latching

Ventilation Options



Solid Door (S) Standard Louvers (O) Mini Louvers (O) Diamond Shaped (A)

Door Options

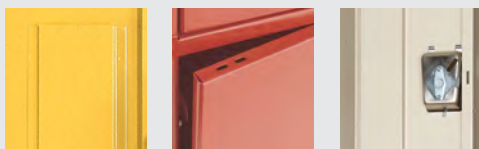

Medallion (O) Guardian PLUS (A) Guardian Defiant II (A)

Door Handle Options

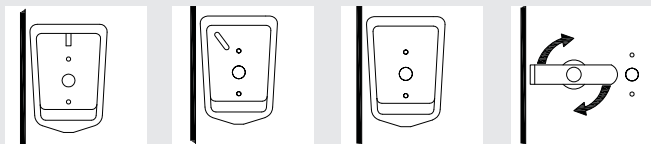

Classic III Recessed (S) Defiant II Recessed (A) Defiant II Rotary Recessed (A) Cremone Turn Handle A - On most Guardian "Plus" models

S = Standard O = Optional* A = Available with 14 gauge door only*
*additional charges may apply

For Guardian specifications, see page 95.

CCBP: Common Color Body Parts (Vanguard and Guardian only): Backs, tops, bottoms, sides, & shelves all come in 073 Champagne as standard. Full color available upon special order at an additional cost. (This excludes Guardian Duplex, 2-person, Galvanneal lockers).



Standard Guardian lockers build upon the design features of the Vanguard series with several enhancements and options that give it a distinctive look.

Our one piece deep drawn Classic III stainless steel recessed pocket is part of every Guardian. It eliminates protrusions from the locker front and accepts a padlock or a built-in lock.

The 16 gauge door front has a solid exterior, aiding quiet operation. Ventilation is achieved by slots in the top and bottom flanges of the door.

Medallion Option: This upgrade has a sound damping panel welded to the door reducing noise levels when doors are slammed.

Guardian PLUS: This upgrade increases the thickness of the door to 14 gauge. The Guardian PLUS locker is ideally suited for corridors and situations where the locker is likely to encounter harsher than normal usage.

Guardian Defiant II: This combines a 14 gauge door with a single point latch stainless steel pocket and a reinforcing pan that stiffens the door. See page 98 for more information.



1 Tier 2 Tier 3 Tier 2 Person Duplex

Sizes and Dimensions

Guardian 1 Tier Lockers

		Standard Door 16 ga.*		Medallion Door 16 ga.*		Guardian PLUS 14 ga.		Defiant II Latch- 14 ga.	
Opening Height		60"	72"	60"	72"	60"	72"	60"	72"
Width	Depth	Cat. No.	Cat. No.	Cat. No.	Cat. No.	Cat. No.	Cat. No.	Cat. No.	Cat. No.
9"	12"	6101G	6151G	6101M	6151M	6C101	6C151	-	-
	15"	6103G	6153G	6103M	6153M	6C103	6C153	-	-
	18"	6105G	6155G	6105M	6155M	6C105	6C155	-	-
12"	12"	6111G	6161G	6111M	6161M	6C111	6C161	6E111	6E161
	15"	6113G	6163G	6113M	6163M	6C113	6C163	6E113	6E163
	18"	6115G	6165G	6115M	6165M	6C115	6C165	6E115	6E165
	21"	6117G	6167G	6117M	6167M	6C117	6C167	6E117	6E167
	24"	6144G	6168G	-	6168M	6C144	6C168	-	-
15"	12"	6119G	6169G	6119M	6169M	6C119	6C169	6E119	6E169
	15"	6121G	6171G	6121M	6171M	6C121	6C171	6E121	6E171
	18"	6123G	6173G	6123M	6173M	6C123	6C173	6E123	6E173
	21"	6125G	6175G	6125M	6175M	6C125	6C175	6E125	6E175
18"	18"	6131G	6181G	-	6181M	6C131	6C181	6E131	6E181
	21"	6133G	6183G	-	6183M	6C133	6C183	6E133	6E183
	24"	6135G	6185G	-	6185M	6C135	6C185	6E135	6E185

Guardian 2 Tier Lockers

		Standard Door 16 ga.*		Medallion Door 16 ga.*		Guardian PLUS 14 ga.		Defiant II Latch - 14 ga.	
Opening Height		30"	36"	30"	36"	30"	36"	30"	36"
Width	Depth	Cat. No.	Cat. No.	Cat. No.	Cat. No.	Cat. No.	Cat. No.	Cat. No.	Cat. No.
9"	12"	-	6230G	-	-	-	-	-	-
	15"	-	6223G	-	-	-	-	-	-
	18"	-	6225G	-	-	-	-	-	-
12"	12"	6211G	6231G	6211M	6231M	6C211	6C231	6E211	6E231
	15"	6213G	6233G	6213M	6233M	6C213	6C233	6E213	6E233
	18"	6215G	6235G	6215M	6235M	6C215	6C235	6E215	6E235
	21"	6217G	6218G	6217M	6218M	6C217	6C218	6E217	6E218
	24"	-	6220G	-	6220M	-	-	-	6E220
15"	12"	6227G	6239G	-	6239M	6C227	6C239	6E227	6E239
	15"	6229G	6241G	-	6241M	6C229	6C241	6E229	6E241
	18"	6237G	6243G	-	6243M	6C237	6C243	6E237	6E243
	21"	6257G	6245G	-	6245M	6C257	6C245	6E257	6E245
	24"	-	6246G	-	6246M	-	-	-	-
18"	18"	-	6247G	-	-	-	6C247	6E281	6E247
	21"	-	6249G	-	-	-	6C249	6E283	6E249
	24"	-	6250G	-	-	-	-	-	-

Guardian Duplex Lockers

		Standard 16 ga.	
Opening Height		72"	
Width	Depth	Cat. No.	
15"	15"	6531G	
	18"	6533G	
	21"	6535G	

Guardian 2 Person Lockers

		Standard 16 ga.		Medallion 16 ga.
Overall Height		60"	72"	72"
Width	Depth	Cat. No.	Cat. No.	Cat. No.
15"	12"	6510G	6500G	-
	15"	6506G	6501G	6501M
	18"	6437G	6503G	6503M
	21"	-	6505G	-
18"	15"	-	6509G	-
	18"	-	6515G	-
	21"	-	6525G	-

Guardian 3 Tier Lockers

		Standard 16 ga.		Medallion 16 ga.	Guardian PLUS 14 ga.		Defiant II Latch 14 ga.	
Opening Height		20"	24"	24"	20"	24"	20"	24"
Width	Depth	Cat. No.	Cat. No.	Cat. No.	Cat. No.	Cat. No.	Cat. No.	Cat. No.
12"	12"	6407G	6419G	6419M	6C407	6C419	6E407	6E419
	15"	6409G	6421G	6421M	6C409	6C421	6E409	6E421
	18"	6411G	6423G	6423M	6C411	6C423	6E411	6E423
	21"	6449G	6499G	6499M	6C449	6C499	6E449	6E499
15"	12"	-	6425G	-	-	6C425	-	6E425
	15"	6451G	6427G	-	-	6C427	6E451	6E427
	18"	6453G	6429G	-	-	6C429	6E453	6E429
	21"	6455G	6437G	-	-	6C437	6E455	6E437

* All dimensions are in inches. Overall Height is the overall height of the locker frame, NOT including legs. Opening Height is the nominal height of the individual door opening.

Opening Height for 2 Person Lockers: for 60" high models, bottom doors are nominal 42" high; for 72" high models, bottom doors are nominal 54" high. Book compartment doors are nominal 9" high each.

* Standard Guardian & Medallion Option doors less than 12" wide are 18 gauge.

NOTE: 1, 2 & 3 Tier, 2 Person and Duplex lockers are ordered by the FRAME. Overall heights do NOT include legs.

At a Glance

- Knocked down construction
- Diamond perforations on door and sides
- 14 ga. door, 16 ga. body & 18 ga. back
- Classic III or Defiant II pocket available on 1, 2 and 3 tier
- Friction on 4 through 6 tier

Ventilation Options



Diamond Shaped (S) Standard Louvers (O) Mini Louvers (O) Solid Door (O)

Door Handle Options

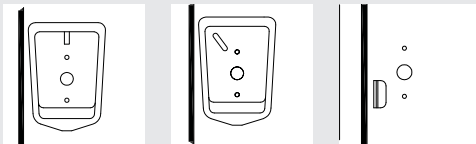

Classic III Recessed (S) Defiant II Recessed (O) Friction Catch (SB)

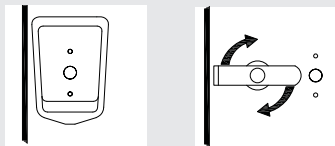

Defiant II Rotary Recessed (A) Cremona Turn Handle (A) On most 1, 2 and 3 Tier Invincible II models

S = Standard O = Optional* A = Available*
 SB = Std. on Box Lockers OB = Optional on Box Lockers*

*additional charges may apply



Penco's Invincible II athletic lockers are an exceptionally attractive and durable choice for gym lockers. Ideal for applications that require a high degree of ventilation and strength, or where visual inspection of locker contents is desired.

Doors are made from heavy 14 gauge steel. Sides, tops, bottoms and shelves are 16 gauge steel. Backs are 18 gauge. Doors and sides are perforated with a diamond-shaped pattern allowing maximum air circulation while maintaining security. Solid doors are an option.

Invincible II lockers come in a variety of styles: 1 tier, 2 tier and 3 tier all have as standard the Classic III stainless steel recessed pocket and multi-point latching. Standard 4, 5, 6, 8 and 9 tier box locker doors have a padlock hasp and a spring loaded latch and will accept built-in locks. Available at extra cost is a spring loaded latch.

Both 2 & 3 tier lockers have horizontal frame members welded between the doors for added strength and security. 24" wide lockers have full width doors. If slope tops are required, use hoods. All lockers accept built-in locks or padlocks and have rubber bumpers on the frame to help reduce noise.



1 Tier 2 Tier 3 Tier 4 Tier 5 Tier 6 Tier 8 Tier 9 Tier

For Invincible II specifications, see page 96.
 For Defiant Doors, see page 98.

Invincible II™

Sizes and Dimensions



Invincible II 1 Tier Lockers					
		Std. Cat. No.		Defiant II	
Overall Ht.		-	-	-	-
Opening Ht.		60"	72"	60"	72"
Width	Depth	Cat. No.	Cat. No.	Cat. No.	Cat. No.
9"	12"	6A101	6A107	-	-
	15"	6A103	6A109	-	-
	18"	6A105	6A111	-	-
12"	12"	6A129	6A157	6P129	6P157
	15"	6A131	6A159	6P131	6P159
	18"	6A135	6A161	6P135	6P161
	21"	6A133	6A163	-	-
15"	15"	6A143	6A169	6P143	6P169
	18"	6A145	6A171	6P145	6P171
	21"	6A147	6A173	6P147	6P173
	24"	-	6A172	-	-
18"	15"	6A149	6A175	6P149	6P175
	18"	6A151	6A177	6P151	6P177
	21"	6A153	6A179	6P153	6P179
	24"	6A155	6A181	6P155	6P181
24"	15"	-	6A182	-	-
	18"	6A117	6A123	6P117	6P123
	21"	6A119	6A125	6P119	6P125
	24"	6A121	6A127	6P121	6P127

Invincible II 2 Tier Lockers					
		Std. Cat. No.		Defiant II	
Overall Ht.		60"	72"	60"	72"
Opening Ht.		30"	36"	30"	36"
Width	Depth	Cat. No.	Cat. No.	Cat. No.	Cat. No.
9"	12"	-	-	-	-
	15"	-	-	-	-
	18"	-	-	-	-
12"	12"	6A213	6A245	6P213	6P245
	15"	6A215	6A247	6P215	6P247
	18"	6A217	6A249	6P217	6P249
	21"	-	6A251	-	-
15"	15"	6A225	6A257	6P225	6P257
	18"	6A239	6A259	6P239	6P259
	21"	6A241	6A261	6P241	6P261
	24"	-	6A253	-	-
18"	15"	6A223	6A263	6P223	6P263
	18"	6A227	6A265	6P227	6P265
	21"	6A229	6A267	6P229	6P267
	24"	6A231	6A269	6P231	6P269
24"	15"	-	-	-	-
	18"	6A233	6A271	6P233	6P271
	21"	6A235	6A273	6P235	6P273
	24"	6A237	6A275	6P237	6P275

Invincible II 3 Tier Lockers					
		Std. Cat. No.		Defiant II	
Overall Ht.		60"	72"	60"	72"
Opening Ht.		20"	24"	20"	24"
Width	Depth	Cat. No.	Cat. No.	Cat. No.	Cat. No.
9"	12"	-	-	-	-
	15"	-	-	-	-
	18"	-	-	-	-
12"	12"	6A287	6A281	6P287	6P281
	15"	6A289	6A283	6P289	6P283
	18"	6A291	6A285	6P291	6P285
	21"	-	-	-	-
15"	15"	6A293	6A301	6P293	6P301
	18"	6A295	6A303	6P295	6P303
	21"	6A297	6A305	6P297	6P305
	24"	-	-	-	-
18"	15"	-	-	-	-
	18"	6A220	6A221	-	-
	21"	-	-	-	-
	24"	-	-	-	-
24"	15"	-	-	-	-
	18"	-	-	-	-
	21"	-	-	-	-
	24"	-	-	-	-

Invincible II 4, 5, 6, 8 & 9 Tier Box Lockers								
		4 Tier		5 Tier		6 Tier	8 Tier	9 Tier
Overall Height		60"	72"	60"	72"	72"	72"	72"
Opening Height		15"	18"	12"	14-2/5"	12"	9"	8"
Width	Depth	Cat. No.	Cat. No.	Cat. No.	Cat. No.	Cat. No.	Cat. No.	Cat. No.
12"	12"	6A307	6A319	6A351	6A363	6A375	6A393	6A407
	15"	6A309	6A321	6A353	6A365	6A377	6A395	6A409
	18"	6A311	6A323	6A355	6A367	6A379	6A397	6A411
	21"	-	-	-	-	6A381	-	-
15"	15"	6A313	6A331	6A357	6A369	6A383	6A401	6A413
	18"	6A315	6A335	6A359	6A371	6A385	6A403	6A415
	21"	-	-	6A361	6A373	6A389	6A405	6A417
18"	18"	-	-	6A419	6A445	6A423	-	-
	21"	-	-	6A421	6A447	6A425	-	-

Group Ends for Invincible II Lockers			
		Perforated Single Row	Solid Single Row
Height	Depth	1 - 6 Tier Cat. No.	1 - 6 Tier Cat. No.
36-1/2"	12"	603600V	603601S
	15"	603602V	603603S
	18"	603704V	603605S
48-1/2"	12"	603606V	603607S
	15"	603608V	603609S
	18"	603700V	603701S
60"	12"	602100V	602101S
	15"	602102V	602103S
	18"	602104V	602105S
	21"	602106V	602107S
	24"	602108V	602109S
72"	12"	602110V	602111S
	15"	602112V	602113S
	18"	602114V	602115S
	21"	602116V	602117S
	24"	602118V	602119S

Ordering Group Ends for Invincible II Lockers

You must order a Group End to finish each group of Invincible II lockers, regardless of length of each group or row. Specify Perforated or Solid.

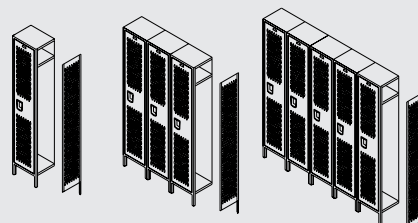

1 Basic Unit 1 Group End 3 Basic Units 1 Group End 5 Basic Units 1 Group End

At a Glance

- 16 ga. body & 18 ga. back for durability
- 14 ga. door and Classic III pocket standard
- Optional Defiant II single point latching
- Ships fully assembled

Ventilation Options



Diamond Shaped (S) Standard Louvers (O) Mini Louvers (O) Solid Door (O)

Base Options



No Legs or Base (S) Channel Base (O)

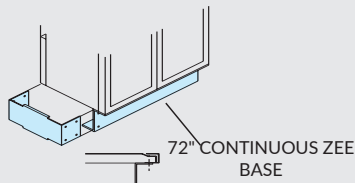

Zee Base (O) - **Must use added support in rear of locker and in between groupings**

Door Handle Options

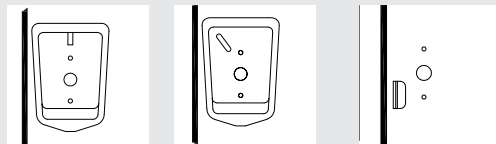

Classic III Recessed (S) Defiant II Recessed (O) Friction Catch (SB)

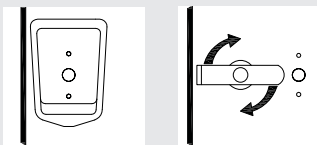

Defiant II Rotary Recessed (O) Cremone Turn Handle (A) On most 1, 2 and 3 Welded Gen2 Tier models



The Welded Gen2 Alternative

Welded Gen2 lockers offer superior resistance to hard use and abuse. All body parts are welded into a single rigid unit to resist damage for the life of the product. The door frame and locker side are 16 gauge. The doors are made from 14 gauge steel and include a continuous hinge. Sides, tops, bottoms and shelves are 16 gauge steel. Backs are 18 gauge.

Since Welded Gen2 lockers are shipped pre-assembled, the time and expense of on-site installation is greatly reduced. This is a great help where labor is either extremely expensive, or hard to find. Groupings will be determined by Penco based upon the floor plan layout drawings submitted with the order. Maximum group width is usually 54" for lockers with a depth up to 18". For lockers over the depth of 18" the groups shall not exceed 48" in total width. If site conditions restrict maximum group width, please advise.

Welded Gen2 lockers are available as standard in ventilated models with diamond-shaped perforations in the doors and sides for maximum visibility and ventilation, or with solid door and side construction, with or without door louvers. The perforated models are ideal for heavy duty athletic use, where ventilation is important to aid the drying of athletic gear.

Standard construction is flat top without legs. Lockers can be ordered with 4" high, 16 gauge Channel Base as an option.

S = Standard O = Optional* A = Available*
 SB = Standard on Box Lockers OB = Optional on Box Lockers*
 *additional charges may apply

For Welded Gen2 specifications, see page 97.
 For Defiant Doors, see page 98.

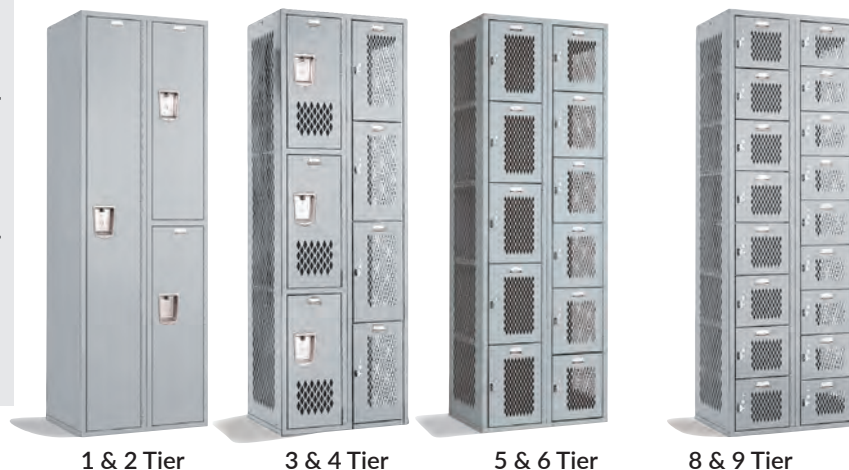

1 & 2 Tier 3 & 4 Tier 5 & 6 Tier 8 & 9 Tier

Sizes and Dimensions

Welded Gen2 1 Tier Lockers					
		Standard Cat. No.		Defiant II Latch	
Opening Height		60"	72"	60"	72"
Unit Width	Unit Depth	Cat. No.	Cat. No.	Cat. No.	Cat. No.
9"	12"	6G101	6G107	-	-
	15"	6G103	6G109	-	-
	18"	6G105	6G111	-	-
12"	12"	6G129	6G157	6GD129	6GD157
	15"	6G131	6G159	6GD131	6GD159
	18"	6G135	6G161	6GD135	6GD161
	21"	6G133	6G163	-	-
15"	12"	6G141	6G165	-	6GD128
	15"	6G143	6G169	6GD143	6GD169
	18"	6G145	6G171	6GD145	6GD171
	21"	6G147	6G173	6GD147	6GD173
	24"	6G112	6G172	-	6GD172
18"	12"	6G501	6G500	6GD501	6GD500
	15"	6G149	6G175	6GD149	6GD175
	18"	6G151	6G177	6GD151	6GD177
	21"	6G153	6G179	6GD153	6GD179
	24"	6G155	6G181	6GD155	6GD181
24"	15"	-	6G182	-	-
	18"	6G117	6G123	6GD117	6GD123
	21"	6G119	6G125	6GD119	6GD125
	24"	6G121	6G127	6GD121	6GD127

Welded Gen2 2 Tier Lockers					
		Standard Cat. No.		Defiant II Latch	
Overall Height		60"	72"	60"	72"
Opening Height		30"	36"	30"	36"
Unit Width	Unit Depth	Cat. No.	Cat. No.	Cat. No.	Cat. No.
12"	12"	6G213	6G245	6GD213	6GD245
	15"	6G215	6G247	6GD215	6GD247
	18"	6G217	6G249	6GD217	6GD249
	21"	6G206	6G251	-	6GD251
15"	12"	6G207	6G252	-	-
	12"	6G208	6G228	6GD208	6GD228
	15"	6G225	6G257	6GD225	6GD257
	18"	6G239	6G259	6GD239	6GD259
	21"	6G241	6G261	6GD241	6GD261
18"	24"	6G212	6G253	-	6GD253
	12"	-	6G508	-	-
	15"	6G223	6G263	6GD223	6GD263
	18"	6G227	6G265	6GD227	6GD265
	21"	6G229	6G267	6GD229	6GD267
24"	24"	6G231	6G269	6GD231	6GD269
	18"	6G233	6G271	6GD233	6GD271
	21"	6G235	6G273	6GD235	6GD273
	24"	6G237	6G275	6GD237	6GD275

Welded Gen2 3 Tier Lockers					
		Std. Cat. No.		Defiant II Latch	
Overall Height		60"	72"	60"	72"
Opening Height		20"	24"	20"	24"
Unit Width	Unit Depth	Cat. No.	Cat. No.	Cat. No.	Cat. No.
12"	12"	6G287	6G281	6GD287	6GD281
	15"	6G289	6G283	6GD289	6GD283
	18"	6G291	6G285	6GD291	6GD285
	21"	6G306	6G326	-	-
	24"	6G292	6G327	-	-
15"	12"	6G308	6G328	-	-
	15"	6G293	6G301	6GD293	6GD301
	18"	6G295	6G303	6GD295	6GD303
	21"	6G297	6G305	6GD297	6GD305
18"	24"	6G312	6G332	-	-
	12"	-	-	-	-
	15"	-	-	-	-
	18"	6G220	6G221	-	6GD221
	21"	6G314	6G334	-	6GD519
24"	6G222	6G224	-	6GD520	

Welded Gen2 4, 5, 6, 8 & 9 Tier Box Lockers								
		4 Tier		5 Tier		6 Tier	8 Tier	9 Tier
Overall Ht.		60"	72"	60"	72"	72"	72"	72"
Opening Ht.		15"	18"	12"	14-2/5"	12"	9"	8"
Unit Width	Unit Depth	Cat. No.	Cat. No.	Cat. No.	Cat. No.	Cat. No.	Cat. No.	Cat. No.
12"	12"	6G307	6G319	6G351	6G363	6G375	6G393	6G407
	15"	6G309	6G321	6G353	6G365	6G377	6G395	6G409
	18"	6G311	6G323	6G355	6G367	6G379	6G397	6G411
	21"	6G406	6G426	6G531	6G526	6G381	-	-
	24"	6G316	6G427	6G532	6G527	6G627	-	-
15"	12"	6G408	6G428	6G356	6G528	6G628	6G828	6G928
	15"	6G313	6G331	6G357	6G369	6G383	6G401	6G413
	18"	6G315	6G335	6G359	6G371	6G385	6G403	6G415
	21"	6G317	6G431	6G361	6G373	6G389	-	6G417
18"	24"	6G412	6G432	6G534	6G374	6G541	-	-
	18"	-	-	6G419	6G445	6G423	-	-
	21"	-	-	6G421	6G447	6G425	-	-

At a Glance

- Knocked Down or Welded construction
- Open Fronts and smooth Frame Channels
- 2 lockable compartment options
- 18 or 24-inch widths available
- 18, 21 and 24-inch depths available

Ventilation

Diamond Perforated Sides (Solid Sides Optional)

Door Handle Option

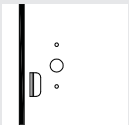

On models equipped with a Security Box

Friction Catch (O)

Accessories



Locking Security Box (O)

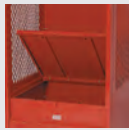

Footlocker (O)

O = Optional* *additional charges may apply

For Stadium specifications, see pages 99-100.

The Right Locker for Athletes and Their Equipment

Penco's Stadium lockers are ideally suited for athletic team rooms, firefighter's equipment or any other application where easy access to uniforms and/or equipment is required.

All Stadium lockers have a Full Width Shelf and a Coat Rod with Hooks. A lockable Security Box and Footlocker are optional. The open Front and optional Diamond Perforated Sides offer full ventilation. All are 1 Tier and 1 wide.

The front of the optional Footlocker is recessed for an external padlock. The Footlocker design saves floor space by eliminating the clutter of open locker doors and the need for separate locker room benches.

Stadium lockers are available in Knocked Down or Welded construction in any of Penco's 24 brilliant colors.



Ordering Matrix

Knocked Down *Order welded for factory assembled Stadium locker.

Patriot STADIUM - KD Locker Part Number Identification Matrix										
S	K	#	#	#	*	*	N	*	*	
Product	Type	Width	Depth	Height	LH Side Vent	RH Side Vent	Channel Base	Security Box	Footlocker	
Product	Type	# Width	# Depth	# Height	* LH Side Vent	* RH Side Vent	* Channel Base	* Sec Box	* Footlocker	
S = Stadium	K = KD	18	18	72	D = Diamond	D = Diamond	N = No channel base	B = Sec Box	F = Footlocker	
		24	18	72						
		24	21	72	S = Solid	S = Solid		N = No Sec Box	N = No Footlocker	
		24	24	72						
Part Number Examples:										
SK242472SSBN					Stadium - KD - 24" wide x 24" deep x 72" high - Solid LH Side - Solid RH Side - Security Box - No footlocker					
SK241872DDBF					Stadium - KD - 24" wide x 24" deep x 72" high - Diamond LH Side - Diamond RH Side - Security Box - Footlocker					

Locker Shell Ordering Guide	
1	Gear, Duty, TA50 and RRDL are ALL WITH Doors
2	Stadium and Turnout are ALL WITHOUT Door
3	ALL Stadium locker part numbers are based on a specific configuration and are not able to be changed, order Turnout if a different configuration is needed
4	ALL Stadium lockers are 1 Tier
5	ALL Stadium lockers are 1 Wide
6	Both KD and Welded Stadium lockers are available with channel base, order channel base separately for KD

Welded

Patriot STADIUM - Welded Locker Part Number Identification Matrix										
S	W	#	#	#	*	*	N	*	*	
Product	Type	Width	Depth	Height	LH Side Vent	RH Side Vent	Channel Base	Security Box	Footlocker	
Product	Type	# Width	# Depth	# Height	* LH Side Vent	* RH Side Vent	* Channel Base	* Sec Box	* Footlocker	
S = Stadium	W = Welded	18	18	72	D = Diamond	D = Diamond	4 = 4 inch high	B = Sec Box	F = Footlocker	
		24	18	72			6 = 6 inch high			
		24	21	72	S = Solid	S = Solid	N = No channel base	N = No Sec Box	N = No Footlocker	
		24	24	72						
Part Number Examples:										
SW242472SSNBN					Stadium - Welded - 24" wide x 24" deep x 72" high - Solid LH Side - Solid RH Side - No channel base - Security Box - No footlocker					
SW242172DD4BF					Stadium - Welded - 24" wide x 21" deep x 72" high - Diamond LH Side - Diamond RH Side - 4 inch high channel base - Security Box - Footlocker					



Fully Framed TA-50 Locker

Penco's TA-50 locker is government and military inspired. Available in Knocked Down or Welded construction, this heavy-duty locker is designed to offer a superior level of security and durability while providing efficient storage for bulky military-grade gear.



- Tubular boxed frame provides rigid construction
- 14 gauge doors with continuous hinge provide full access and secure storage
- Flattened Expanded Metal sides of this tactical TA-50 locker allows for maximum ventilation

- 78" overall locker height
- 36", 42", and 48" widths available
- 4" or 6" high Channel Base available

Fully Framed TA-50 Locker

- True Fully Framed construction offers better rigidity
- 36, 42, and 48-inch widths available
- All are 24" deep and 78" high
- Ultra Cremone Recessed Handle for a safer, cleaner look and less freight damage
- Double Doors available in solid, diamonds, or louvers
- Knocked Down or Welded construction
- 4 or 6-inch high Channel Base optional
- All TA-50 lockers are 1 tier
- All TA-50 lockers are 1 wide
- Solid or Flattened Expanded Metal sides available
- 16-gauge continuous hinge



For TA-50 specifications, see pages 101-102.



PATRIOT® TA-50 Identification Matrix

Knocked Down and Welded

*Order welded for factory assembled TA-50 locker.

Locker Shell Ordering Guide	
1	Gear, Duty, TA50 and RRDL are ALL WITH Doors
2	Stadium and Turnout are ALL WITHOUT Doors
3	ALL TA50 lockers are 1 Tier
4	ALL TA50 lockers are 1 Wide
5	Both KD and Welded TA50 lockers are available with channel base, order channel base separately for KD
6	TA50 lockers are based on a specific configuration, all TA50 lockers come with Hat Shelf, Coat Rod and Hooks

Patriot TA50 - KD Locker Part Number Identification Matrix

M	K	#	#	#	*	*	N	D	C	*
Product	Type	Width	Depth	Height	LH Side Vent	RH Side Vent	Channel Base	Door type	Handle Type	Door Vent



Product	Type	# Width	# Depth	# Height	* LH Side Vent	* RH Side Vent	* Channel Base	* Door Type	* Handle Type	* Door Vent
M = TA50 Military	K = KD	36	24	78	E = Expanded	E = Expanded	N = No channel base	D - Double	C = Ultra Cremone Recessed Handle	D = Diamond
		42			S = Solid	S = Solid				S = Solid
		48								L = Louvers

Part Number Examples:

MK362478EEDCD	(M) TA50 - KD - 36" wide x 24" deep x 78" high - Expanded LH Side - Expanded RH Side - Double Door - Ultra Cremone Recessed Handle - Diamond Door
MK422478SSDCL	(M) TA50 - KD - 42" wide x 24" deep x 78" high - Solid LH Side - Solid RH Side - Double Door - Ultra Cremone Recessed Handle - Louvers Door

Patriot TA50 - Welded Locker Part Number Identification Matrix

M	W	#	#	#	*	*	N	D	C	*
Product	Type	Width	Depth	Height	LH Side Vent	RH Side Vent	Channel Base	Door type	Handle Type	Door Vent



Product	Type	# Width	# Depth	# Height	* LH Side Vent	* RH Side Vent	* Channel Base	* Door Type	* Handle Type	* Door Vent
M = TA50 Military	W = Welded	36	24	78	E = Expanded	E = Expanded	4 = 4 inch high	D - Double	C = Ultra Cremone Recessed Handle	D = Diamond
		42			S = Solid	S = Solid	6 = 6 inch high			S = Solid
		48					N = No channel base			L = Louvers

Part Number Examples:

MW422478EEDCD	(M) TA50 - Welded - 42" wide x 24" deep x 78" high - Expanded LH Side - Expanded RH Side - Double Door - Ultra Cremone Recessed Handle - Diamond Door
MW482478SSDCL	(M) TA50 - Welded - 48" wide x 24" deep x 78" high - Solid LH Side - Solid RH Side - Double Door - Ultra Cremone Recessed Handle - Louvers Door

Fully Framed Gear Locker

A properly equipped, double-door Patriot Gear locker can be the ideal solution for a variety of specialized storage challenges. The ample storage areas at both top and bottom of the 24 - 48 inch-wide and 72-inch high locker leaves nearly four feet between the shelves for hanging uniforms and other gear.

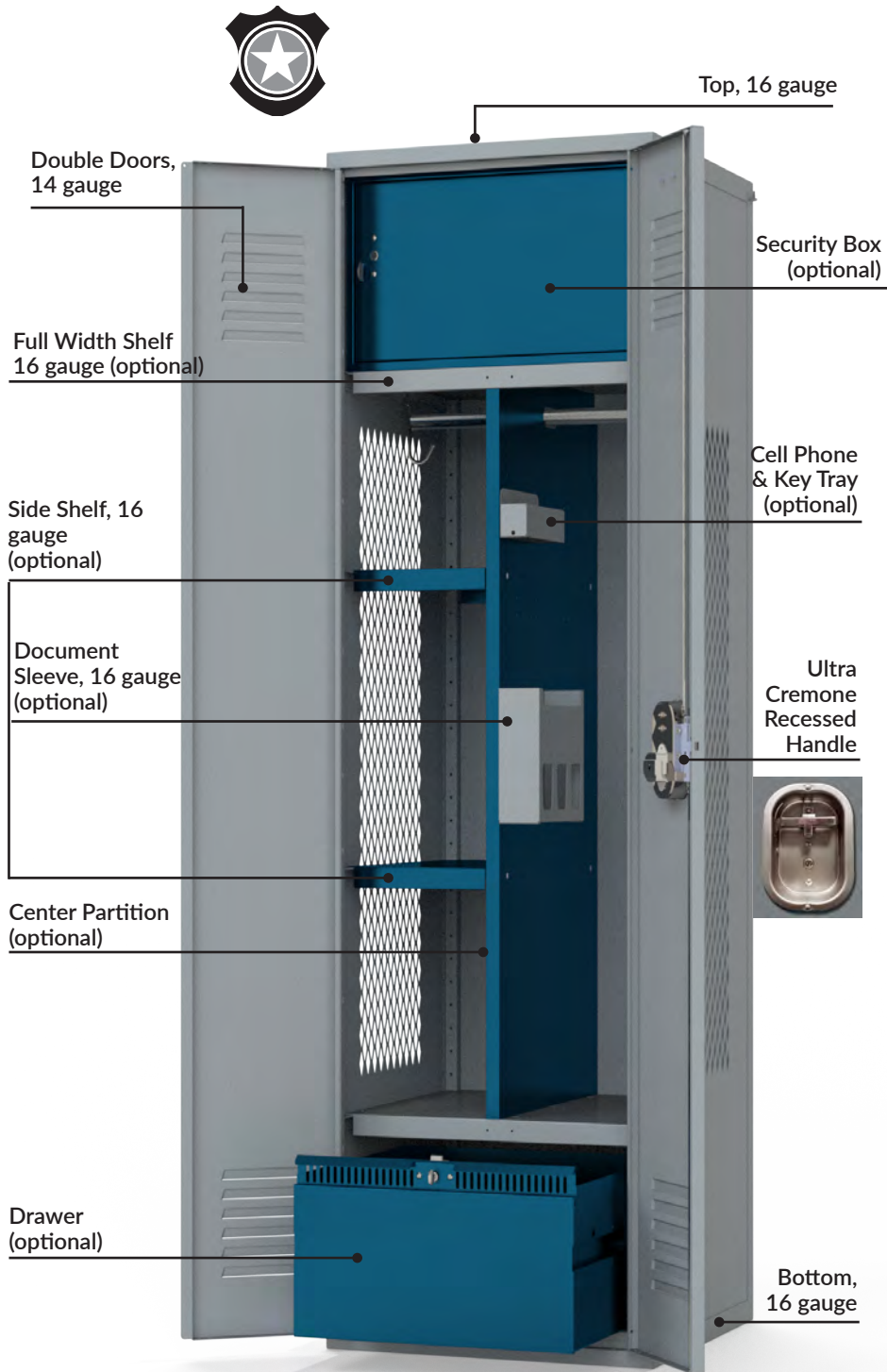

Distinguishing Features:

- True Fully Framed construction offers better rigidity
- Offered in Knocked Down or Welded construction
- 4 or 6-inch high Channel Base available
- 72 or 78-inch heights available
- 18-inch depth available with 18 or 24-inch widths
- 24-inch depth available with 18, 24, 30, 36, 42, or 48-inch widths
- Ultra Cremone Recessed Handle for a safer, cleaner look and less freight damage
- High degree of configurability



Patriot Gear locker is shown above in two-tone colors. Contact a Penco Representative for more details.

Fully Framed Gear Locker

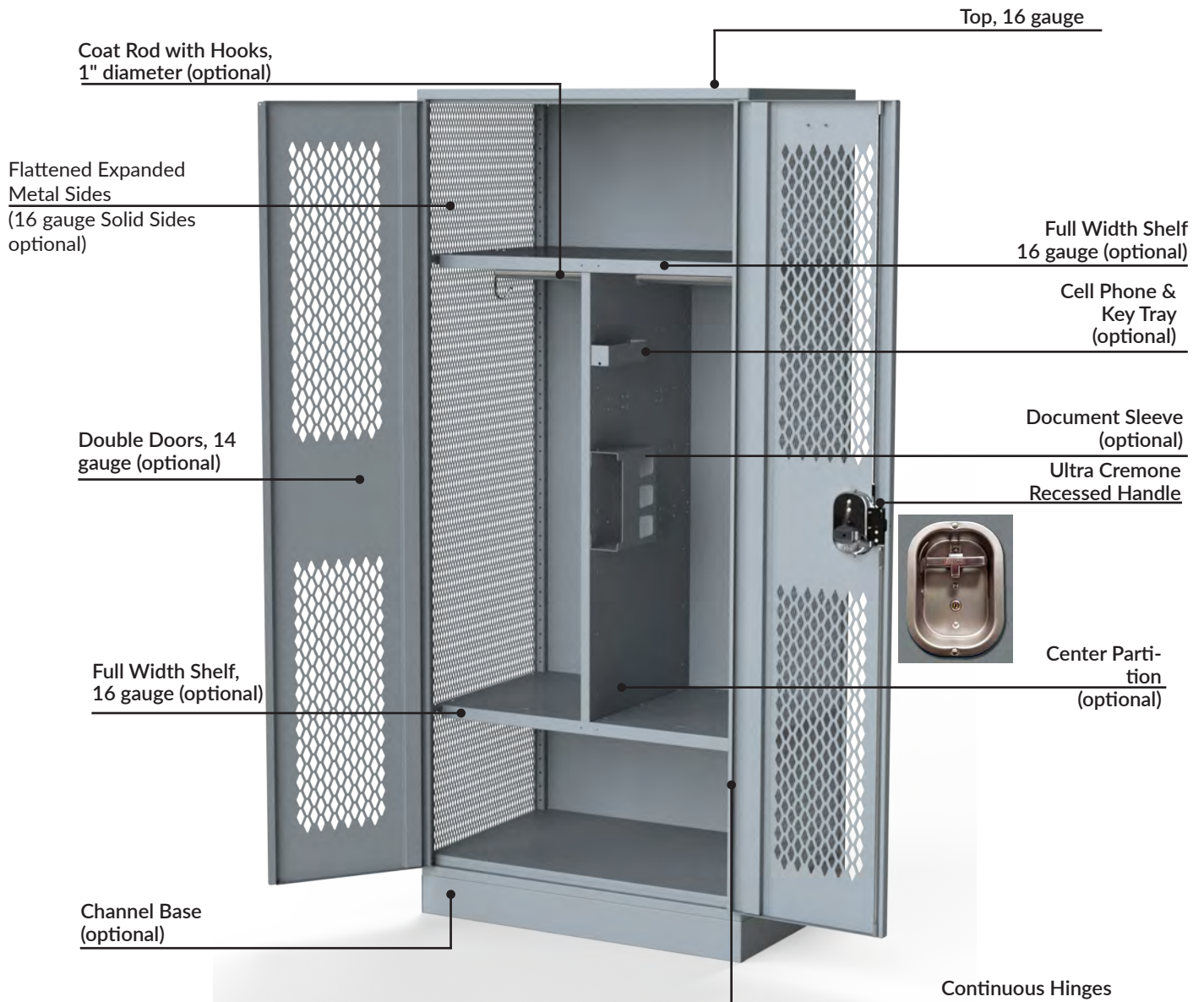

For Gear specifications, see pages 103-106.

Gear Locker Easy-Order Pre-Configurations					
(Based on popular preferences. For custom configurations, see ordering matrix on pages 10 & 11)					
Part Number	Type	Width	Features	Accessories	Drawing
6GK36247201	KD	36	Solid Sides, No Channel Base, Double Doors with Louvers, Ultra Cremone Recessed Handle, 24" deep, 72" high	Shelf, 2 Coat Rods, Hooks, Partition, 2 Drawers	
6GK48247201		48			
6GW36247201	Welded	36			
6GW48247201		48			
6GK36247202	KD	36	Solid Sides, No Channel Base, Double Doors with Louvers, Ultra Cremone Recessed Handle, 24" deep, 72" high	Shelf, 1 Coat Rods, Hooks, 2 Drawers	
6GK48247202		48			
6GW36247202	Welded	36			
6GW48247202		48			
6GK24247205	KD	24	Flattened Expanded Metal Sides, No Channel Base, Double Doors with Louvers, Ultra Cremone Recessed Handle, 24" deep, 72" high	Shelf, Coat Rod, Hooks, Security Box	
6GK48247205		48			
6GW24247205	Welded	24			
6GW48247205		48			
6GK36247206	KD	36	Diamond Sides, No Channel Base, Double Doors with Louvers, Ultra Cremone Recessed Handle, 24" deep, 72" high	Shelf, Coat Rod, Hooks, Two Security Boxes	
6GK48247206	KD	48			
6GW36247206	Welded	36			
6GW48247206	Welded	48			
6GK24247207	KD	24	Flattened Expanded Metal Sides, No Channel Base, Double Doors with Louvers, Ultra Cremone Recessed Handle, 24" deep, 72" high	Shelf, Coat Rod, Hooks, 3 Half Shelves	
6GK36247207	KD	36			
6GW24247207	Welded	24			
6GW36247207	Welded	36			
6GK24247208	KD	24	Flattened Expanded Metal Sides, No Channel Base, Double Doors with Louvers, Ultra Cremone Recessed Handle, 24" deep, 72" high	Shelf, Coat Rod, Hooks	
6GK36247208	KD	36			
6GW24247208	Welded	24			
6GW36247208	Welded	36			

Knocked Down



Locker Shell Ordering Guide	
1	Gear, Duty, TA50 and RRDL are ALL WITH Doors
2	Stadium and Turnout are ALL WITHOUT Doors
3	Lockers over 24 inches wide are only available in 24 inches in depth
4	ALL Gear lockers come with ONLY the Ultra Cremone Recessed Handle. No other handle is available at this time.
5	ALL 18" wide Gear lockers are Single Door ONLY. All 24" wide Gear lockers are available in both Single Door and Double Door. All Gear lockers over 24" wide are Double Door ONLY.
6	Diamond Sides are NOT available for 78" high lockers
7	ALL Gear lockers are 1 Tier
8	ALL Gear lockers are 1 Wide
9	Both KD and Welded Gear lockers are available with channel base
10	Gear lockers are totally configurable, for that reason, hat shelf and coat rods need to be order separately

*Order welded for factory assembled Gear locker.

Patriot GEAR - KD Locker Part Number Identification Matrix											
G	K	#	#	#	*	*	N	*	*	*	
Product	Type	Width	Depth	Height	LH Side Vent	RH Side Vent	Channel Base	Door type	Handle Type	Door Vent	
Product	Type	# Width	# Depth	# Height	* LH Side Vent	* RH Side Vent	* Channel Base	* Door Type	* Handle Type	* Door Vent	
G = Gear	K = KD	18	18	72 and 78	D = Diamond (see #6 above)	D = Diamond (see #6 above)	N = No channel base	S = Single	C = Ultra Cremone Recessed Handle	D = Diamond	
			24								E = Expanded
		24	S = Solid		S = Solid	D - Double		L = Louvers			
		30									
		36									
		42									
48											
Part Number Examples:											
GK362472DSDCL					Gear - KD - 36" wide x 24" deep x 72" high - Diamond LH Side - Solid RH Side - Double door - Ultra Cremone Recessed Handle - Louver Door						

Welded



Locker Shell Ordering Guide	
1	Gear, Duty, TA50 and RRDL are ALL WITH Doors
2	Stadium and Turnout are ALL WITHOUT Door
3	Lockers over 24 inches wide are only available in 24 inches in depth
4	ALL Gear lockers come with ONLY the Ultra Cremone Recessed Handle. N other handle is available at this time.
5	ALL 18" wide Gear lockers are Single Door ONLY. All 24" wide Gear lockers are available in both Single Door and Double Door. All Gear lockers over 24" wide are Doble Door ONLY.
6	Diamond Sides are NOT available for 78" high lockers
7	ALL Gear lockers are 1 Tier
8	ALL Gear lockers are 1 Wide
9	Both KD and Welded Gear lockers are available with Channel Base
10	Gear lockers are totally configurable, for that reason, hat shelf and coat rods need to be order separately

Patriot GEAR - Welded Locker Part Number Identification Matrix											
G	W	#	#	#	*	*	N	*	*	*	
Product	Type	Width	Depth	Height	LH Side Vent	RH Side Vent	Channel Base	Door type	Handle Type	Door Vent	
Product	Type	# Width	# Depth	# Height	* LH Side Vent	* RH Side Vent	* Channel Base	* Door Type	* Handle Type	* Door Vent	
G = Gear	W = Welded	18	18	72 and 78	D = Diamond (see #6 above)	D = Diamond (see #6 above)	4 = 4 inch high	S = Single	C = Ultra Cremone Recessed Handle	D = Diamond	
										24	S = Solid
		24	24	E = Expanded	E = Expanded	6 = 6 inch high	D - Double	L = Louvers			
										S = Solid	S = Solid
Part Number Examples:											
GW362472DS4DCL					Gear - Welded - 36" wide x 24" deep x 72" high - Diamond LH Side - Solid RH Side - 4" Channel Base - Double Door - Ultra Cremone Recessed Handle - Louver Door						

Fully Framed Turnout Locker



Turnout lockers give you the advantage of instant access to mission gear, and Patriot accessories like drawers, security boxes or footlockers give you secure storage for items that are best kept under lock and key.

Whether the Patriot you specify has doors or not, the same flexibility is built into each one. Gear and Turnout accessories are designed for use in either type locker.

Balance the advantage of an open front locker with secure storage by adding a Security Box, Drawers or a Footlocker.

Full Width Shelf, 16 gauge (optional)

Coat Rod with Hooks (optional)

Top, 16 gauge

Security Box (optional)

Channel Base 14 gauge (optional)



For Turnout specifications, see pages 107-108.

Fully Framed Turnout Locker

The key to any turnout locker is the ability to grab and go. The Patriot Turnout Locker puts everything from flight gear to EMS equipment within reach. The Patriot Turnout Locker shares the same heavy-gauge steel construction as Gear lockers but have an open front and smooth frame, allowing users to retrieve equipment in a flash.



Top, 16 gauge

Distinguishing Features:

- True fully framed construction offers better rigidity
- Offered in Knocked Down or Welded construction
- 4 or 6-inch high Channel Base available
- Open front and hemmed frame
- 24-inch deep available in 18, 24, 30, 36, 42, or 48-inch widths
- 18-inch deep locker available in 18 or 24-inch widths
- Available in 72 or 78-inch heights
- Number plates mount to the shelf face for easy visibility

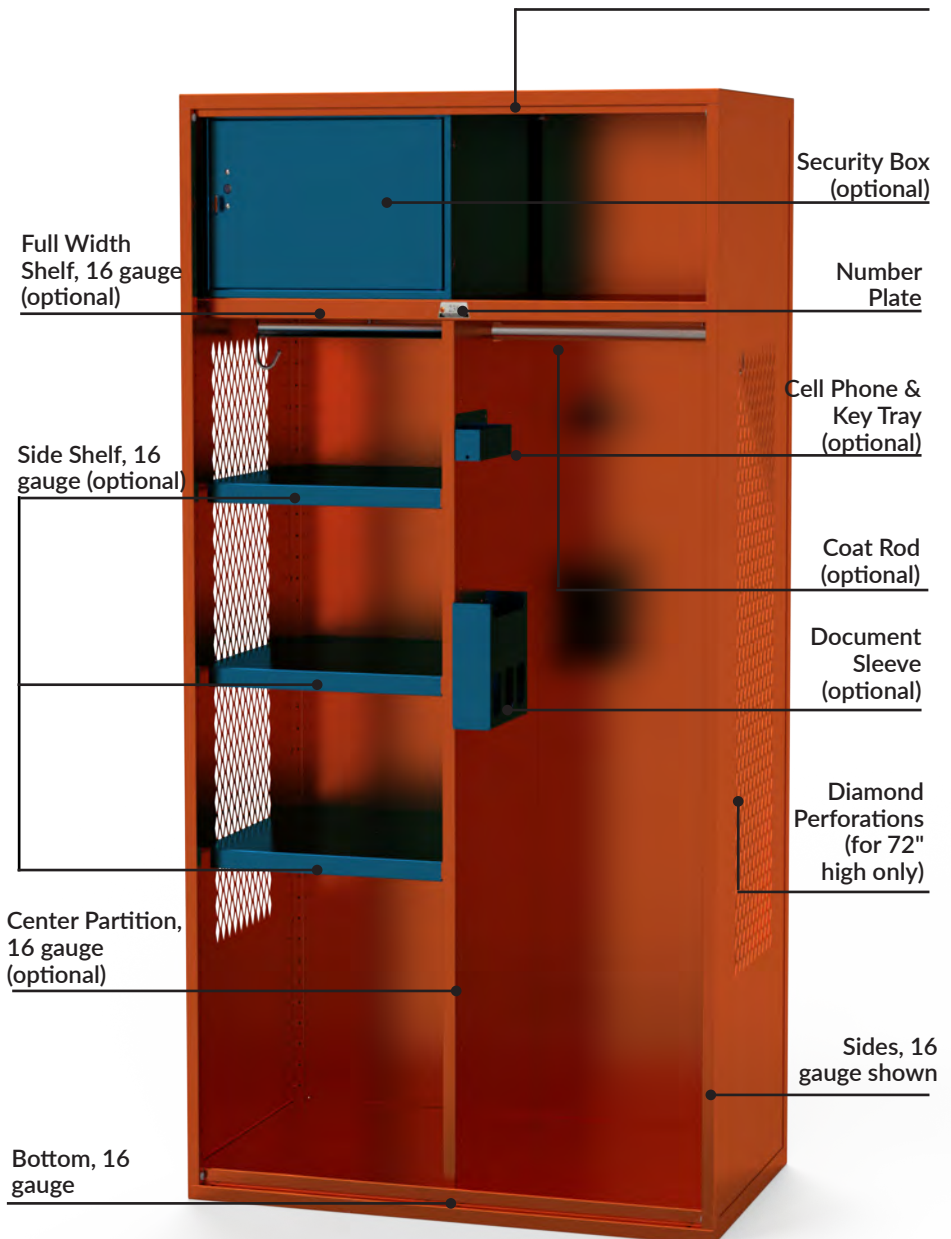

Penco Turnout locker is shown above in two-tone using standard colors. For more information about two-tone lockers, contact your Penco Representative.

Fully Framed Turnout Identification Matrix

Locker Shell Ordering Guide	
1	Gear, Duty, TA50 and RRDL are ALL WITH Doors
2	Stadium and Turnout are ALL WITHOUT Door
3	Lockers over 24 inches wide are only available in 24 inches in depth
4	If ordering 78" high lockers - Diamond Sides are NOT available

5	ALL Turnout lockers are 1 Tier
6	ALL Turnout lockers are 1 Wide
7	Both KD and Welded Turnout lockers are available with Channel Base
8	Turnout lockers are totally configurable, for that reason, hat shelf and coat rods need to be order separately

Patriot TURNOUT - KD Locker Part Number Identification Matrix

T	K	#	#	#	*	*	N
Product	Type	Width	Depth	Height	LH Side Vent	RH Side Vent	Channel Base

*Order Welded for factory assembled Turnout locker.

Product	Type	# Width	# Depth	# Height	* LH Side Vent	* RH Side Vent	* Channel Base
T = Turnout	K = KD	18	72 and 78	18	D = Diamond (see # 4 above)	D = Diamond (see # 4 above)	N = No channel base
				24			
		24		18	E = Expanded	E = Expanded	
				30			
				36	S = Solid	S = Solid	
				42			
48							

Part Number Examples:

TK181872DS	Turnout - KD - 18" wide x 18" deep x 72" high - Diamond LH Side - Solid RH Side
TK482472ES	Turnout - KD - 48" wide x 24" deep x 72" high - Expanded LH Side - Solid RH Side



Patriot TURNOUT - Welded Locker Part Number Identification Matrix

T	W	#	#	#	*	*	*	Locker rules: 1) Gear, Duty, TA50, & RRDL are ALL WITH doors. 2) Stadium & Turnout are ALL WITHOUT doors. 3) Lockers over 24" wide are only available in 24" depth. 4) Diamond sides are NOT available for 78" high lockers. 5) All Turnout lockers are 1 tier and 1 wide. 6) Both KD and Welded Turnout lockers are available with channel base. Order channel base separately for KD. 7) Because Turnout lockers are totally configurable, hat shelf and coat rods need to be ordered separately.
Product	Type	Width	Depth	Height	LH Side Vent	RH Side Vent	Channel Base	

Product	Type	# Width	# Depth	# Height	* LH Side Vent	* RH Side Vent	* Channel Base
T = Turnout	W = Welded	18	72 and 78	18	D = Diamond (see #4 above)	D = Diamond (see #4 above)	4 = 4 inch high
				24			E = Expanded
		24		18	S = Solid	S = Solid	N = No channel base
				30			
				36			
				42			
48							



Fully Framed Duty Locker

With the special needs of law enforcement in mind, the Patriot Duty Locker has a 16 gauge welded shell, 16-gauge drawer, and provides 3.4 cubic feet of usable storage in the drawer base. The 33 or 36-inch deep base optionally accepts individual or continuous lengths of Hardwood Bench Seating.

Security Box
(optional)

Full Width Shelf
(optional)

Half Shelf,
16 gauge
(optional)

Hardwood Bench
Seating (required -
order separately)

Drawer



Coat Rod with
Hooks, 1" (optional)

Inner Compartment
Door (optional)

Ultra Cremone
Recessed Handle

Distinguishing Features:

- Offered in Knocked Down or Welded construction
- Optional 16 gauge Interior Divider and Side Shelf
- 78 or 90-inch Heights available
- 18 or 24-inch widths available
- Optional Coat Rod and Hooks on garment side
- Optional lockable Security Box
- Back punched for electrical wiring
- Standard Drawer Base for all Duty lockers
- Ultra Cremone Recessed Handle

When timing is crucial, Duty lockers answer the call of law enforcement and security professionals. The customizable features of Duty lockers help users find critical items quickly.

For Duty specifications, see pages 109-112.

Order welded for factory assembled models.

Duty Locker: Easy-Order Configurations

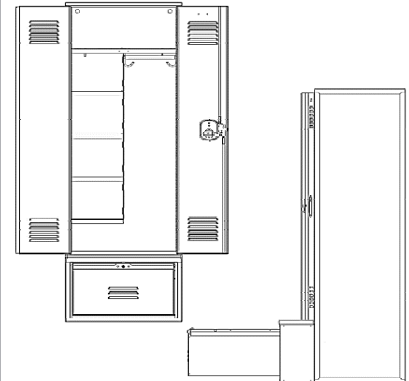
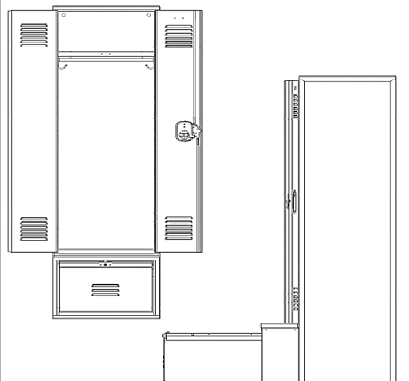
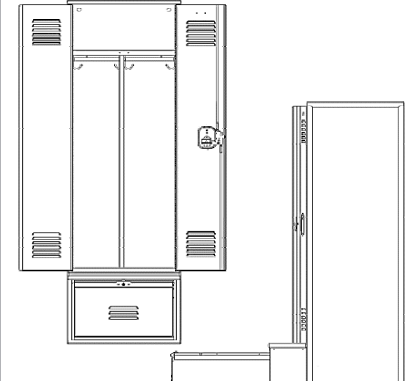
Duty Locker Easy-Order Pre-Configurations				
(Based on popular preferences. For custom configurations, see ordering matrix on pages 17)				
Part Number	Type	Features	Accessories	Drawing
6DK24249009	KD	24" wide, 24" Deep, 90" high. Solid Sides, no Channel Base, Double Doors, Ultra Cremone Recessed Handles, and Louvers	Top Shelf, Coat Rod, Hooks, 4 Half Shelves, 9 inch Extended Front	
6DW24249009	W		Top Shelf, Coat Rod, Hooks, 4 Half Shelves, 9 inch Extended Front	
6DK24249010	KD	24" wide, 24" Deep, 90" high. Solid Sides, no Channel Base, Double Doors, Ultra Cremone Recessed Handles, and Louvers	Top Shelf, Coat Rod, Hooks, 9 inch Extended Front	
6DW24249010	W		Top Shelf, Coat Rod, Hooks, 9 inch Extended Front	
6DK24249011	KD	24" wide, 24" Deep, 90" high. Solid Sides, no Channel Base, Double Doors, Ultra Cremone Recessed Handles, and Louvers	Top Shelf, Center Partition, 2 Coat Rods, Hooks, 9 inch Extended Front	
6DW24249011	W		Top Shelf, Center Partition, 2 Coat Rods, Hooks, 9 inch Extended Front	



PATRIOT[®] Duty Identification Matrix



Locker Shell Ordering Guide	
1	Gear, Duty, TA50 and RRDL are ALL WITH Doors
2	Stadium and Turnout are ALL WITHOUT Door
3	ALL Gear lockers come with ONLY the Ultra Cremone Recessed Handle. No other handle is available at this time.
4	ALL 18" wide Gear lockers are Single Door ONLY. All 24" wide Gear lockers are available in both Single Door and Double Door. All Gear lockers over 24" wide are Double Door ONLY.

5	Ordering a Duty locker means a Drawer Base Unit will be provided, if drawer base is not needed order a Gear locker. Examples: 90" high locker is a 72" locker with an nominal 18" high drawer base. 78" high locker will be a 60" locker with an nominal 18" high drawer base.
6	ALL Duty lockers are 1 Tier
7	ALL Duty lockers are 1 Wide
8	ALL Duty lockers come with a Drawer Base Unit
9	Duty lockers are NOT available with channel base because of the drawer base unit
10	Duty lockers are totally configurable, for that reason, hat shelf and coat rods need to be order separately
11	When ordering a Front Extension for the drawer base unit the final depth of the base wil be as noted below:
11a	Drawer base unit with a 9" extension on a 24" deep locker will be 33" deep
11b	Drawer base unit with a 12" extension on a 24" deep locker will be 36" deep

*Order welded for factory assembled Duty locker.

Patriot DUTY - KD Locker Part Number Identification Matrix

D	K	#	#	#	S	S	*	*	*	*
Product	Type	Width	Depth	Height	LH Side Vent	RH Side Vent	Drawer Base Extension	Door Type	Handle Type	Door Vent

Product	Type	# Width	# Depth	# Height	* LH Side Vent	* RH Side Vent	Drawer Base Ext	* Door Type	* Handle Type	* Door Vent
D = Duty	K = KD	18	24	78	S = Solid	S = Solid	N = 9" front extension (See #9 above for details)	S = Single	C = Ultra Cremone Recessed Handle	D = Diamond
				90						= Solid
		78		E = 12" front extension (See #9 above for details)			D = Double	L = Louvers		
		90								

Part Number Examples:

DK182490SSESL	Duty - KD - 18" wide x 24" deep x 90" high (means 72" lkr with 18" high Drawer Base) - Solid LH Side - Solid RH Side - (E) 12" Front Drawer Extension - Single Door - Ultra Cremone Recessed Handle - Louver Door
DK242478SSNDCS	Duty - KD - 24" wide x 24" deep x 78" high (means 60" lkr with 18" high Drawer Base) - Solid LH Side - Solid RH Side - (N) 9" Front Drawer Extension - Double Door - Ultra Cremone Recessed Handle - Solid Door

Patriot DUTY - Welded Locker Part Number Identification Matrix

D	W	#	#	#	S	S	*	*	*	*
Product	Type	Width	Depth	Height	LH Side Vent	RH Side Vent	Drawer Base Extension	Door Type	Handle Type	Door Vent

Product	Type	# Width	# Depth	# Height	* LH Side Vent	* RH Side Vent	Drawer Base Ext	* Door Type	* Handle Type	* Door Vent
D = Duty	W = Welded	18	24	78	S = Solid	S = Solid	N = 9" front extension (See #9 above for details)	S = Single	C = Ultra Cremone Recessed Handle	= Diamond
				90						= Solid
		78		E = 12" front extension (See #9 above for details)			D = Double	L = Louvers		
		90								

Part Number Examples:

DW182478SSNSCL	Duty - Welded - 18" wide x 24" deep x 78" high (means 60" lkr with 18" high Drawer Base) - Solid LH Side - Solid RH Side - (N) 9" Front Drawer Extension - Single Door - Ultra Cremone Recessed Handle - Louver Door
DW242490SSEDCS	Duty - Welded - 24" wide x 24" deep x 90" high (means 72" lkr with 18" high Drawer Base) - Solid LH Side - Solid RH Side - (E) 12" Front Drawer Extension - Double Door - Ultra Cremone Recessed Handle - Solid Door



Fully Framed Gear & Turnout Lockers

Configure and Build to Suit

One of the key strengths of the Patriot is its flexibility and modular accessories. Each Patriot accessory is designed for use in any of the four Patriot Locker bodies.

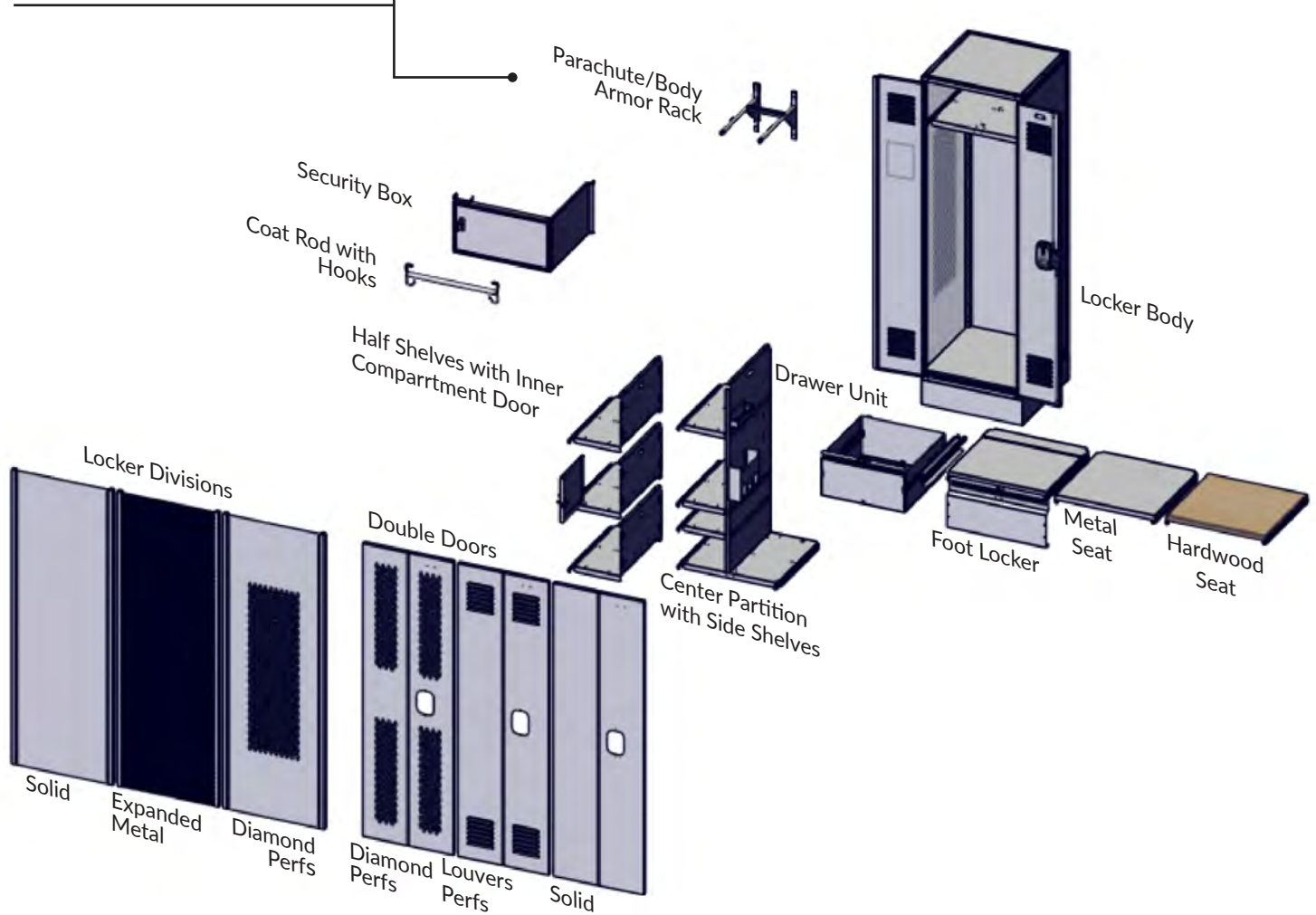

For more information about locker configurations, contact your Penco Representative.

Locker Accessories (Not for TA-50* or Stadium*)

**Exception: The 4 or 6-inch high Channel Base is still an option for both TA-50 and Stadium*

The accessories listed here will help you to personalize and organize the lockers to fit your needs.

Cell Phone/Key Tray:

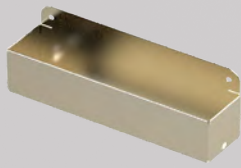

The 8" x 2" x 2" tray is sized for holding and organizing phones, radios, or keys and can be mounted to the flanged partition side of half shelf or center partition.

Document Sleeve:



Formed from 16 gauge steel, the document sleeve is available in either a vertical or horizontal configuration for efficient storage of portfolios, note pads or binders.

Boot Tray:

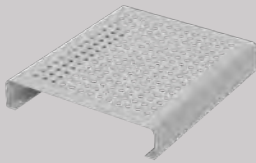

The 12" x 14" boot tray provides air space between soiled or wet footwear and the locker bottom. A series of round hole perforations are used to promote airflow and the tray is kept from marring the locker finish by rubber pads. Not for use on 18" wide lockers with center partition.

Coat Rod with hooks - Full Length:



Using coat rod hooks mounted to shelf. 18", 24", 30", 36", 42", 48" width sizes correlating to the width of the locker.

Acrylic Mirror:



The adhesive-backed mirror resists breakage and can be permanently mounted wherever you need it.

Coat Rod with hooks - Half Length:



Using coat rod hooks mounted to shelf and used on lockers with center partition or half shelves. 9" for 18" wide locker, 12" for 24" wide locker, 15" for 30" wide locker, 18" for 36" wide locker, 21" for 42" wide locker and 24" for 48" wide locker.

Security Box:

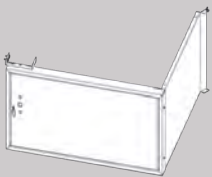

Available in many widths, the security box uses a 18 gauge lockable door, 16 gauge side panel and welded door frame. Uses any standard box locker padlock or built in lock. (lock sold separately)

Half Shelf:



L-shaped half shelf, 16 gauge steel. Attaches securely on one side with a side rail and the flanged partition mounts to shelf or half shelf above.

Parachute/Body Armor Rack:

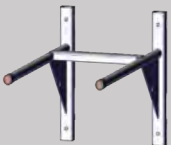

Formed from 3/4 inch diameter heavy wall steel tube and reinforced by 14 gauge gussets and supports for hanging heavy flight gear or body armor. Ordering this option replaces the standard rear mounted coat hooks.

Side Shelf:

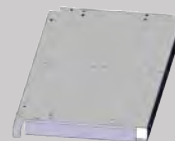

Shelf is only used with center partitions when shelves are needed on either side. 9" for 18" wide locker, 12" for 24" wide locker, 15" for 30" wide locker, 18" for 36" for locker, 21" for 42" wide locker and 24" for 48" wide locker.

Garment Separator:



Can be used as an alternative to the optional Coat Rod. Mounts to shelf.

Hook:



Single Prong - mounts to shelf.

Locker Accessories (Not for TA-50* or Stadium*)

**Exception: The 4 or 6-inch high Channel Base is still an option for both TA-50 and Stadium*

Channel Base:



4-inch or 6-inch high. 14 gauge steel formed in a "C" channel that attaches to locker bottom.

Full Width Shelf:



16 gauge steel. Attaches securely to mounting side rails. Comes with 2 Back Hooks. Order Back Rails when additional shelf support is needed.

Center Partition:

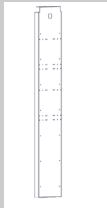

16 gauge steel with a flanged front. Attaches securely to shelf and locker bottom or additional lower shelf. (Not for use with footlocker or seat). Mounting holes for side shelves provided on nominal 6 inch centers.

Back Rails:

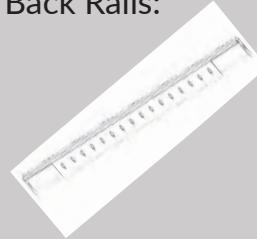

Back Rails are used with full width shelves when extra support is needed. Order one back rail per full width shelf. The size of the back rail correlates with the width of the shelf.

Bottom 12" High Drawer:

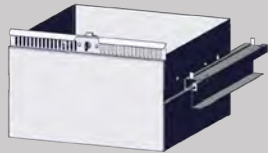

12 inch high and constructed of 16 gauge sheet steel. Provides easy access to files and equipment without taking up valuable space when not in use. Must order shelf for above this drawer. (lock sold separately)

Intermediate 6" High Drawer:

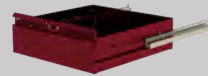

6 inch high and constructed of 16 gauge sheet steel. Can be stacked inside locker. Provides easy access to files and equipment without taking up valuable space when not in use. Must order shelf for above the first drawer. If ordering multiple drawers and each drawer needs to be locked a shelf must be ordered for each drawer. (lock sold separately)

Wood Seat Option:



Used in place of a footlocker or drawer unit, the 1-1/4" thick solid hardwood bench provides a sturdy seating surface with open storage underneath for stowing larger bags or equipment.

Metal Seat Option:



Used in place of a footlocker or drawer unit, the 16 gauge metal seat provides a sturdy seating surface with open storage underneath for stowing larger bags or equipment.

Footlocker:

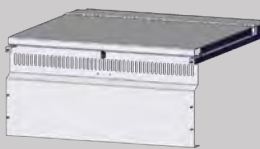

The reinforced lid of the footlocker features a continuous hinge and also serves as a seat. The front panel includes a single point latch with a padlock strike plate for security and vertical ventilation. (lock sold separately)

Inner Compartment Door:

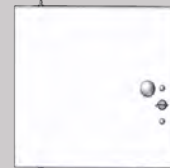

Used only with "L" shaped half shelf. 18 gauge steel. (lock sold separately)

Additional Accessories:

Standard Penco locker accessories such as vertical fillers, continuous slope hood, locker room benches and recess trim are available for use on Patriot Fully Framed Lockers. See Penco price book for details.

For locker Accessories **specifications**, see pages 113-115.

Locker Accessories (Not for TA-50 or Stadium)

Description	Part #	Size
Center Partition	6FCP1844-K	18 x 44
	6FCP1844-W	18 x 44
	6FCP1857-K	18 x 57
	6FCP1857-W	18 x 57
	6FCP1851-K	18 x 51
	6FCP1851-W	18 x 51
	6FCP2451-K	24 x 51
	6FCP2451-W	24 x 51
	6FCP2444-K	24 x 44
	6FCP2444-W	24 x 44
Side Shelf (used with center partitions)	6FCPHS0918-K	9 x 18
	6FCPHS0918-W	9 x 18
	6FCPHS0924-K	9 x 24
	6FCPHS0924-W	9 x 24
	6FCPHS1218-K	12 x 18
	6FCPHS1218-W	12 x 18
	6FCPHS1224-K	12 x 24
	6FCPHS1224-W	12 x 24
	6FCPHS1524-K	15 x 24
	6FCPHS1524-W	15 x 24
	6FCPHS1824-K	18 x 24
	6FCPHS1824-W	18 x 24
	6FCPHS2124-K	21 x 24
	6FCPHS2124-W	21 x 24
	6FCPHS2418-K	24 x 18
6FCPHS2418-W	24 x 18	
6FCPHS2424-K	24 x 24	
6FCPHS2424-W	24 x 24	
Coat Rod Kit - Full Length	6FCR18-K	18
	6FCR18-W	18
	6FCR24-K	24
	6FCR24-W	24
	6FCR30-K	30
	6FCR30-W	30
	6FCR36-K	36
	6FCR36-W	36
	6FCR42-K	42
	6FCR42-W	42
Coat Rod Kit - Half Length (9" wide, use with 18" wide lkr)	6FCRH09-18K	9
	6FCRH09-18W	9
Coat Rod Kit - Half Length (12" wide, use with 24" wide lkr)	6FCRH12-24K	12
	6FCRH12-24W	12
Coat Rod Kit - Half Length (15" wide, use with 30" wide lkr)	6FCRH15-30K	15
	6FCRH15-30W	15
Coat Rod Kit - Half Length (18" wide, use with 36" wide lkr)	6FCRH18-36K	18
	6FCRH18-36W	18
Coat Rod Kit - Half Length (21" wide, for use with 42" wide lkr)	6FCRH21-42K	21
	6FCRH21-42W	21
Coat Rod Kit - Half Length (24" wide, for with 48" wide lkr)	6FCRH24-48K	24
	6FCRH24-48W	24

Description	Part #	Size
Bottom Drawer - 12" High (bottom of locker only)	6FDU181812-K	18 x 18 x 12
	6FDU181812-W	
	6FDU182412-K	18 x 24 x 12
	6FDU182412-W	
	6FDU241812-K	24 x 18 x 12
	6FDU241812-W	
	6FDU242412-K	24 x 24 x 12
	6FDU242412-W	
	6FDU302412-K	30 x 24 x 12
	6FDU302412-W	
Bottom Drawer - 12" High (bottom of locker only) actually 18" wide, goes into a 36" w locker	6FDU362412-K	36 x 24 x 12
	6FDU362412-W	
Bottom Drawer - 12" High (bottom of locker only) actually 21" wide goes into a 42" w locker	6FDU422412-K	42 x 24 x 12
	6FDU422412-W	
Bottom Drawer - 12" High (bottom of locker only) actually 24" wide goes into a 48" w locker	6FDU482412-K	48 x 24 x 12
	6FDU482412-W	
Intermediate Drawer - 6" High	6FDU181806-K	18 x 18 x 6
	6FDU181806-W	
	6FDU182406-K	18 x 24 x 6
	6FDU182406-W	
	6FDU241806-K	24 x 18 x 6
	6FDU241806-W	24 x 18 x 6
	6FDU242406-K	24 x 24 x 6
	6FDU242406-W	
	6FDU301806-K	30 x 18 x 6
	6FDU301806-W	
	6FDU302406-K	30 x 24 x 6
	6FDU302406-W	
	6FDU362406-K	36 x 24 x 6
	6FDU362406-W	
6FDU422406-K	42 x 24 x 6	
6FDU422406-W		
6FDU482406-K	48 x 24 x 6	
6FDU482406-W		
Footlocker	6FFT181812-K	18 x 18 x 12
	6FFT181812-W	
	6FFT182412-K	18 x 24 x 12
	6FFT182412-W	
	6FFT241812-K	24 x 18 x 12
	6FFT241812-W	
	6FFT242412-K	24 x 24 x 12
	6FFT242412-W	
	6FFT302412-K	30 x 24 x 12
	6FFT302412-W	
	6FFT362412-K	36 x 24 x 12
	6FFT362412-W	
	6FFT422412-K	42 x 24 x 12
	6FFT422412-W	
6FFT482412-K	48 x 24 x 12	
6FFT482412-W		

Locker Accessories (Not for TA-50 or Stadium)

Description	Part #	Size	Description	Part #	Size
Half Shelf	6FHSH0924-K	9 x 24	Security Box (for top of shelf only)	6FSB918-K	9 x 18
	6FHSH0924-W			6FSB918-W	
	6FHSH1218-K	12 x 18		6FSB924-K	9 x 24
	6FHSH1218-W		6FSB924-W		
	6FHSH1224-K	12 x 24	Security Box (for top of shelf only) Actually 10.5" wide could put 4 in a 42 wide locker	6FSB1118-K	11 x 18
	6FHSH1224-W			6FSB1118-W	
	6FHSH1518-K	15 x 18		6FSB1124-K	11 x 24
	6FHSH1518-W		6FSB1124-W		
	6FHSH1524-K	15 x 24	Security Box (for top of shelf only)	6FSB1218-K	12 x 18
	6FHSH1524-W			6FSB1218-W	
	6FHSH1818-K	18 x 18		6FSB1221-K	12 x 21
	6FHSH1818-W			6FSB1221-W	
	6FHSH1824-K	18 x 24		6FSB1224-K	12 x 24
	6FHSH1824-W			6FSB1224-W	
	6FHSH2118-K	21 x 18		6FSB1518-K	15 x 18
	6FHSH2118-W			6FSB1518-W	
	6FHSH2124-K	21 x 24		6FSB1524-K	15 x 24
	6FHSH2124-W			6FSB1524-W	
	6FHSH2418-K	24 x 18		6FSB1818-K	18 x 18
6FHSH2418-W	6FSB1818-W				
6FHSH2424-K	24 x 24	6FSB1824-K		18 x 24	
6FHSH2424-W		6FSB1824-W			
Inner compartment door (in half shelf only)	6FCMPT09-K	9		6FSB2118-K	21 x 18
	6FCMPT09-W			6FSB2118-W	
	6FCMPT12-K			12	6FSB2124-K
	6FCMPT12-W	6FSB2124-W			
	6FCMPT15-K	15		6FSB2418-K	24 x 18
	6FCMPT15-W		6FSB2418-W		
	6FCMPT18-K	18	6FSB2424-K	24 x 24	
	6FCMPT18-W		6FSB2424-W		
	6FCMPT21-K	21	Security Box Panel for inside of inner compartment door when your ordering an expended metal division and you want to block	STL100718-K	18" deep
	6FCMPT21-W			STL100718-W	
6FCMPT24-K	24	STL100724-K		24" deep	
6FCMPT24-W		STL100724-W			
Inner Compartment Panels: for inside of inner compartment door when your ordering an expended metal division and you want to block the view.	STLCMPT18-K	18" deep	Full Width Shelf Comes with 2 Back Hooks	6FSH1818-K	18 x 18
	STLCMPT18-W			6FSH1818-W	
	STLCMPT24-K	24" deep		6FSH1824-K	18 x 24
	STLCMPT24-W			6FSH1824-W	
Metal Seat	6FFSEAT1818-K	18 x 18		6FSH2418-K	24 x 18
	6FFSEAT1818-W			6FSH2418-W	
	6FFSEAT2418-K	24 x 18		6FSH2421-K	24 x 21
	6FFSEAT2418-W			6FSH2421-W	
	6FFSEAT2424-K	24 x 24		6FSH2424-K	24 x 24
	6FFSEAT2424-W			6FSH2424-W	
	6FFSEAT3024-K	30 x 24		6FSH3024-K	30 x 24
	6FFSEAT3024-W			6FSH3024-W	
	6FFSEAT3624-K	36 x 24		6FSH3624-K	36 x 24
	6FFSEAT3624-W			6FSH3624-W	
	6FFSEAT4224-K	42 x 24	6FSH4224-K	42 x 24	
	6FFSEAT4224-W		6FSH4224-W		
	6FFSEAT4824-K	48 x 24	6FSH4824-K	48 x 24	
	6FFSEAT4824-W		6FSH4824-W		

Locker Accessories (Not for TA-50* or Stadium*)

**Exception: The 4 or 6-inch high Channel Base is still an option for both TA-50 and Stadium*

Description	Part #	Size
Garment Separator - Full Width - Replaces Coat Rod	6FGARM-18HK	18 x 2
	6FGARM-18HW	18 x 2
	6FGARM-24HK	24 x 2
	6FGARM-24HW	24 x 2
	6FGARM-30HK	30 x 2
	6FGARM-30HW	30 x 2
	6FGARM-36HK	36 x 2
	6FGARM-36HW	36 x 2
	6FGARM-42HK	42 x 2
	6FGARM-42HW	42 x 2
	6FGARM-48HK	48 x 2
	6FGARM-48HW	48 x 2

Description	Part #	Size
Back Rails - For full width shelves when extra support is needed. Also used for parachute/body armor rack when ordering the rack with partitions and half shelves.	FF1010-18-B-K	18"
	FF1010-18-B-W	
	FF1010-24-B-K	24"
	FF1010-24-B-W	
	FF1010-30-K	30"
	FF1010-30-W	
	FF1010-36-K	36"
	FF1010-36-W	
	FF1010-42-K	42"
	FF1010-42-W	
FF1010-48-K	48"	
FF1010-48-W		
Hardwood Bench Seat	6FBENCH1818HK	18 x 18
	6FBENCH1818HW	18 x 18
	6FBENCH1824HK	18 x 24
	6FBENCH1824HW	18 x 24
	6FBENCH2418HK	24 x 18
	6FBENCH2418HW	24 x 18
	6FBENCH2424HK	24 x 24
	6FBENCH2424HW	24 x 24
	6FBENCH3024HK	30 x 24
	6FBENCH3024HW	30 x 24
	6FBENCH3624HK	36 x 24
	6FBENCH3624HW	36 x 24
	6FBENCH4224HK	42 x 24
	6FBENCH4224HW	42 x 24
	6FBENCH4824HK	48 x 24
	6FBENCH4824HW	48 x 24
Individual Hardwood Seat (for Duty Lockers)	6RQ1242-K	18 x 9.5 x 1.25
	6RQ1242-W	
	6RQ0575-K	24 x 9.5 x 1.25
	6RQ0575-W	
	6RQ11224-K	18 x 12 x 1.25
	6RQ11224-W	
	6RQQ722-K	24 x 12 x 1.25
	6RQQ722-W	
Channel Base - 4 inch high	6FCBW1818-4K	18 x 18 x 4
	6FCBW1818-4W	
	6FCBW1824-4K	18 x 24 x 4
	6FCBW1824-4W	
	6FCBW2418-4K	24 x 18 x 4
	6FCBW2418-4W	
	6FCBW2421-4K	24 x 21 x 4
	6FCBW2421-4W	
	6FCBW2424-4K	24 x 24 x 4
	6FCBW2424-4W	
	6FCBW3024-4K	30 x 24 x 4
	6FCBW3024-4W	
	6FCBW3624-4K	36 x 24 x 4
	6FCBW3624-4W	
	6FCBW4224-4K	42 x 24 x 4
	6FCBW4224-4W	
6FCBW4824-4K	48 x 24 x 4 ³	
6FCBW4824-4W		

**Exception: The 4 or 6-inch high Channel Base is still an option for both TA-50 and Stadium*

Description	Part #	Size
Channel Base - 6 inch high	6FCBW1818-6K	18 x 18 x 6
	6FCBW1818-6W	
	6FCBW1824-6K	18 x 24 x 6
	6FCBW1824-6W	
	6FCBW2418-6K	24 x 18 x 6
	6FCBW2418-6W	
	6FCBW2421-6K	24 x 21 x 6
	6FCBW2421-6W	
	6FCBW2424-6K	24 x 24 x 6
	6FCBW2424-6W	
	6FCBW3024-6K	30 x 24 x 6
	6FCBW3024-6W	
	6FCBW3624-6K	36 x 24 x 6
	6FCBW3624-6W	
	6FCBW4224-6K	42 x 24 x 6
6FCBW4224-6W		
6FCBW4824-6K	48 x 24 x 6	
6FCBW4824-6W		
Hooks (single prong - mounts to shelf)	8696	
Cell Phone / Key Tray	60830H	8 x 2
Acrylic Mirror With adhesive back: 1/8" thick Cannot be attached to doors with diamond or visual perforations, mini-louvers and quiet sound-deadening panels.	96370	6 x 8
Parachute / Body Armor Rack (order back rails if ordering with partition or half shelves) See Back Rails in accessories for sizes and pricing	6ACXAB33C-K	18
Parachute / Body Armor Rack (order back rails if ordering with partition or half shelves) See Back Rails in accessories for sizes and pricing	6ACXAB33C-W	18
Boot Tray Rests on bottom of locker or lower shelf. Fits 24" or wider lockers	6ACXFF09H	14 x 12
Name Card Holder Size shown is card size. NOTE: Add \$2.25 each to punch holes in door for attaching	9446H	2-3/4 x 1-1/4
Document Sleeve - Small (mounts to half shelf or center partition)	6ACXAB32C	9.5 x 3 x 8
Document Sleeve - Large (mounts to half shelf or center partition)	6ACXFF54C	12 x 3 x 8

All Patriot Lockers can be outfitted with a number of locking options. While all models are designed to use readily available locker locks, some options requires specific lock types.

A – Gear and Turnout Security Boxes are hinged on the right and can be equipped with any box locker lock including padlocks.

B – The standard Ultra Cremone Recessed Handle on Gear lockers can accept a padlock or built-in lock.

C – Left Hand Inner Compartment Door accepts most built-in dead bolt locks. It does not have a padlock attachment.

D – Right Hand Inner Compartment Door accepts most built-in dead bolt locks. It does not have a padlock attachment.

E – Gear and Turnout Footlockers have a padlock attachment and no provision for built-in locks.

F – Intermediate Drawer for Gear and Turnout are configured to work best with a built-in spring bolt key for ease of use.

G – Bottom Drawers are configured to work best with a built-in spring bolt key for ease of use.

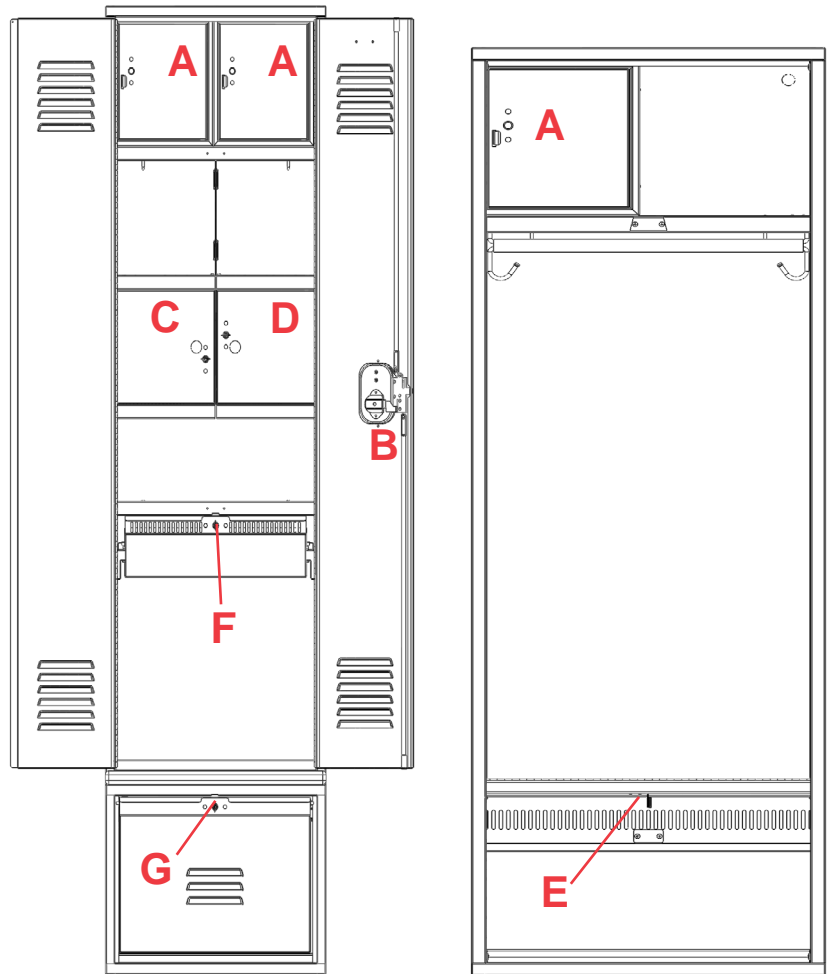

	Padlock	Keyed Spring Bolt	Keyed Dead Bolt	Combination Spring Bolt	Combination Dead Bolt
A	PREFERRED	OK	OK	OK	OK
B	OK	REFER TO LOCK APPLICATION TABLE IN LOCKER PRICE BOOK			
C	NO	PREFERRED (LH)	OK (LH)	OK (LH)	OK (LH)
D	NO	PREFERRED (RH)	OK (RH)	OK (RH)	OK (RH)
E	ONLY	NO	NO	NO	NO
F	NO	PREFERRED	OK	NO	NO
G	NO	PREFERRED	OK	NO	NO

Accessories/Locker Growth

The illustration below shows several locker groups with frequently ordered accessories.

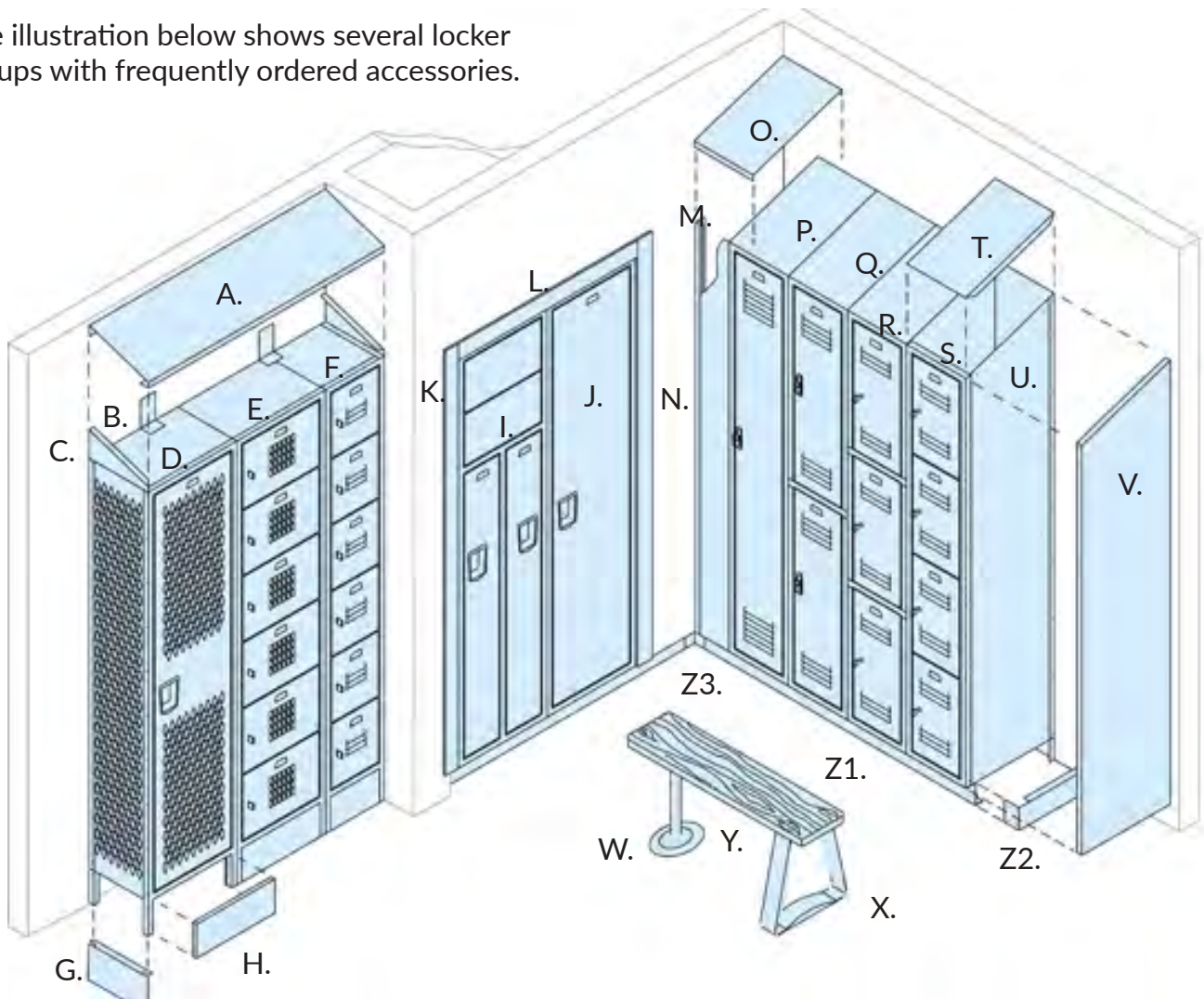

Key for Illustration

- A. Slope Hood
- B. Universal Rear Hood Support
- C. Slope End for Hood L.H. (Left Hand)
- D. Single Tier Invincible
- E. 6 Tier Box Locker w/Visual Doors
- F. 6 Tier Box Locker w/Std. Louvers
- G. End Base, 6" High
- H. Front Base, 6" High

- I. Two Person Guardian
- J. Single Tier Guardian
- K. Side Recess Trim
- L. Top Recess Trim
- M. Wall Angle Slip Joint
- N. Vertical Filler
- O. Filler, Slope Top
- P. Single Tier Vanguard
- Q. Double Tier Vanguard
- R. Three Tier Vanguard

- S. Four Tier Vanguard
- T. Slope Top, Unit Construction
- U. Slope Top Division (Side)
- V. Boxed Finished End Panel (Right Hand)
- W. Heavy Duty Bench Pedestal
- X. Stainless Steel Bench Pedestal
- Y. Hardwood Bench
- Z1. Zee Base, 4" high
- Z2. Zee End Base/Splice
- Z3. Zee Inside Corner Splice

Locker "Growth"

When planning an installation of Knocked Down lockers, allow an additional 1/16" for each frame. When planning an installation of Welded lockers, allow an additional 1/16" per group.

Accessories

Slope Top Construction

Slope tops are often used instead of flat tops to prevent the accumulation of dust and debris, and to discourage the use of locker tops as storage areas. There are three different types of slope top construction: Unit Slope Tops, Slope Hoods, and Slope Top Kits. Each is explained below.



Unit Slope Tops

Unit Slope Tops cover the width of one locker frame only. Lockers with Unit Slope Tops have sides with mitered top ends with a rise equal to 1/3 of the locker depth, plus longer backs that meet the rear edge of the slope top. Unit slope tops are used in place of the standard flat tops.

Order the appropriate locker plus the proper slope top size. Not for use on Invincible II, Welded, Stadium or Patriot lockers.



Slope Top Kits

Designed to convert stock flat top lockers into slope top lockers in groups of 3 wide. Each kit contains 3 tops, 3 backs and 4 ends. Not for use on Invincible II, Welded, Stadium or Patriot lockers.

Universal Rear Hood Support

Used with 12", 15" 18", 21" and 24" deep hood only.

Typical Slope Hood Installation

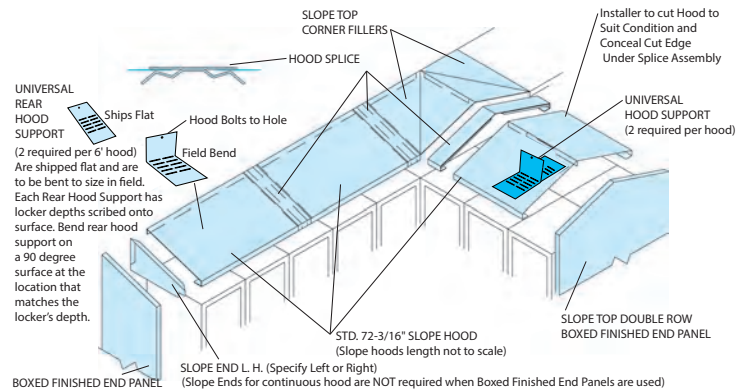

Continuous Slope Hoods

Continuous slope hoods fit on top of flat top lockers. They can be used on new lockers or on a retrofit basis. All hoods are furnished in 72" lengths and must be cut to length during installation. Intermediate splices and hood ends complete the installation and must be ordered separately. Hoods come with 2 rear supports, if extra supports are needed, order separately.

Continuous Slope Splice	
Unit Depth	Cat. No.
13"	6HDX484C
16"	6HDX127C
19"	6HDX473C

Slope Ends			
Unit Depth	Unit Height	Left Hand Cat. No.	Right Hand Cat. No.
12"	5"	66158H	66159H
15"	6"	66160H	66161H
18"	7"	66162H	66163H
21"	8"	66164H	66165H
24"	9"	66166H	66167H

Hood Splice		
Unit Depth	Unit Height	Cat. No.
12"	5"	66168C
15"	6"	66169C
18"	7"	66170C
21"	8"	66171C
24"	9"	66172C

Unit Slope Tops		
Unit Width	Unit Depth	Cat. No.
9"	12"	60332C
	15"	60334C
	18"	60336C
12"	12"	60338C
	15"	60340C
	18"	60342C
	21"	60344C
15"	12"	603450C
	15"	60346C
	18"	60348C
	21"	60350C
18"	18"	60352C
	21"	60354C
	24"	60356C
24"	18"	60364C
	21"	60366C
	24"	60368C

Continuous Slope Hoods			
Unit Length	Unit Depth	Unit Height	Cat. No.
72"	13"	5.3"	6HDX330H
	16"	6.3"	6HDX124H
	19"	7.3"	6HDX471H

Use only when lockers need to be 1 inch away from wall. Includes 1 piece of hood and 2 hood supports. Do NOT use with STANDARD size Slope Ends, Slope Top Corner Fillers, Hip Fillers or Finished End Panels. See special Splices & Hood Supports for these hoods below.

Slope Hoods*			
Unit Depth	Unit Height	Unit Width	Cat. No.
12"	5"	72"	66144H
15"	6"	72"	66147H
18"	7"	72"	66150H
21"	8"	72"	66153H
24"	9"	72"	66156H

*Includes 1 piece of hood and 2 hood supports.

Continuous Slope Supports	
Unit Height	Cat. No.
5.3"	6HDX480C
6.3"	6HDX481C
7.3"	6HDX474C

Continuous Hood Ends			
Left/Right	Unit Depth	Unit Height	Cat. No.
LH	13"	5.3"	6HDX642H
RH	13"	5.3"	6HDX643H
LH	16"	6.3"	6HDX125H
RH	16"	6.3"	6HDX126H
LH	19"	7.3"	6HDX694H
RH	19"	7.3"	6HDX695H

Slope Top Kits - 3 Wide			
Unit Width	Unit Depth	Unit Height	Cat. No.
12"	12"	4"	60230H
	15"	5"	60232H
	18"	6"	60234H
15"	15"	5"	60238H
	18"	6"	60240H
18"	18"	6"	60244H

Accessories

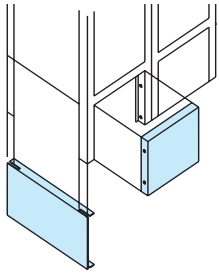

Individual Closed Bases

Front and end bases are designed to fit between standard Penco 6" legs. They present a clean flush appearance and prevent the accumulation of dust and dirt under the lockers. Front Base snaps in; End Base slips over legs during locker assembly. Only available for knocked down lockers with 6" legs.

SPLICE/END BASE

Zee Bases

Zee bases raise lockers without legs 4" off the floor when there is no concrete or wood base. They provide a toe space in the front and a concealed flange for floor anchoring at the rear. A special 4" high rear leg can be ordered to support the back of the locker. (6" high zee bases are also available.)

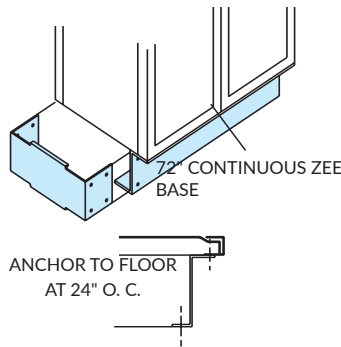

ANCHOR TO FLOOR AT 24" O. C.

Zee bases are available only in 72" lengths, and may need to be cut to fit at the time of installation. Splices/End Bases are used at ends of rows, and where the front sections join. Must use extra support in rear and between lockers.

Fillers

Penco provides standard fillers to adapt lockers to a wide range of field conditions and provide a professional, finished appearance. Fillers can be used to cover columns, pipes or other obstacles in a row of lockers, or fill the gap between the lockers and a wall.

Vertical Fillers. These come in three widths and are designed to be used in conjunction with Wall Angle Slip Joints for a solid fit and smooth finish. The slip joint conceals any raw edges caused by field cutting. Additional sizes are available. (Illustration at right.)

Top Fillers. Top Fillers cover gaps between tops of lockers. They overlap the locker tops and can be field cut to allow for pipes, etc. There are separate designs for flat top and slope top, and in-line vs. corner applications (illustration below).

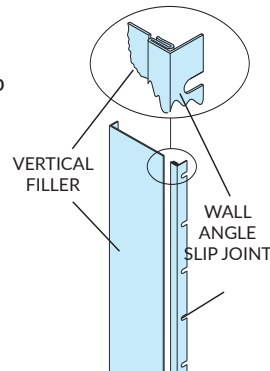

Slope Top Fillers are not to be used with slope hoods. Slope Top Corner Fillers can be used with Slope Hoods or Unit Slope Tops

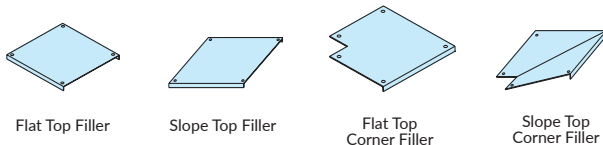

Individual Closed Bases - 6" High

Unit Width	Unit Depth	Cat. No.
Front Bases		
9"	-	60216C
12"	-	60217C
15"	-	60218C
18"	-	60219C
24"	-	60220C
End Bases Single Row		
-	12"	60204C
-	15"	60205C
-	18"	60206C
-	21"	60207C
-	24"	60208C
End Bases Double Row		
-	24"	60209C
-	30"	60210C
-	36"	60211C

Zee Bases - 72" Width

Unit Depth	Unit Height	Cat. No.
Front Zee Bases		
-	4"	66700H
Splice/End Base Single Row		
12"	4"	66701H
15"	4"	66702H
18"	4"	66703H
21"	4"	66704H
24"	4"	66705H
Splice/End Base Double Row		
30"	4"	66707H
24"	4"	66706H
36"	4"	66708H
Zee Inside Corner Splice		
-	4"	66709H
Rear Leg for Zee Base		
-	4"	60092C

Vertical Fillers

Unit Width	Unit Height	Cat. No.
Vertical Angles		
5"	60"	66112C
	72"	66115C
9"	60"	66114C
	72"	66117C
	78"	66127C
12"	60"	66113C
	72"	661141C
	78"	66116C
Wall Angle Slip Joints		
-	60"	66118C
-	72"	66119C
-	78"	66121C

Top Fillers

Unit Width	Unit Depth	Cat. No.
Flat Top Fillers		
15"	12"	661321C
	15"	661322C
	18"	661323C
Slope Top Fillers		
15"	12"	661371C
	15"	661372C
	18"	661373C
Flat Top Corner Fillers		
12"	12"	66138C
15"	15"	66139C
18"	18"	66140C
Slope Top Corner Fillers		
12"	12"	66100C
15"	15"	66101C
18"	18"	66102C

Accessories



Extra Steel Locker Shelves

Extra locker shelves can be added to K.D. lockers to meet special user requirements. Most lockers have extra holes already punched into side panels for mounting. In some cases shelf mounting holes may need to be drilled. Please consult your Penco sales representative for shelf mounting requirements.

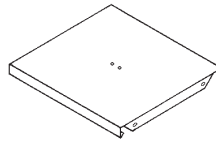

Pictured: Single Tier Vanguard Locker with 5 shelves.

Recess Trim

Recess trim is 3" wide and bridges the gap between lockers and wall and/or soffits when the lockers are recessed into a wall. Side trim for left hand (LH) and right hand sides (RH) are different. Side Trim comes in three types: 1) for use with lockers with no legs, 2) with 6" legs and 3) for use with Bottom Recess Trim.

The soffit is to be constructed by general contractor. Face of soffit must be flush with face of locker. There should be 1" between top of locker and bottom of soffit. The recessed trim extends 3/8" from face of soffit.



Recess Trim - 3" High		
Unit Width	Unit Depth	Cat. No.
Top Trim		
74"	-	60456H
Splice		
2"	-	66105C
Outside Corner Splice		
2"	2"	66108C
Bottom Trim		
72"	-	60458C

Recess Side Trim - 3" Wide	
Unit Height	Cat. No.
Side Trim - LH (Use with lockers that have No Legs)	
63"	60465C
75"	60469C
87"	60473C
Side Trim - RH (Use with lockers that have No Legs)	
63"	60466C
75"	60470C
87"	60474C
Side Trim - LH (Use with Top Trim & 6" Legs)	
69"	60467C
81"	60471C
93"	60475C
Side Trim - RH (Use with Top Trim & 6" Legs)	
69"	60468C
81"	60472C
93"	60476C
Side Trim - LH (Use with Top & Bottom Trim)	
66"	60477C
78"	60479C
90"	60481C
Side Trim - RH (Use with Top & Bottom Trim)	
66"	60478C
78"	60480C
90"	60482C

Front View of Locker with Recessed Trim

Lockers must be anchored to base (base and wood to be completed by General Contractor)

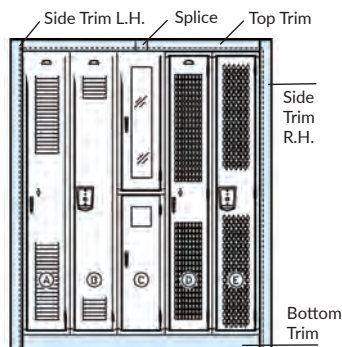

- A. Vanguard with recessed handle
- B. Fire extinguisher/waste bin door
- C. Vanguard w/optional visual perf
- D. Invincible II

Example of Side View of Base and Anchor

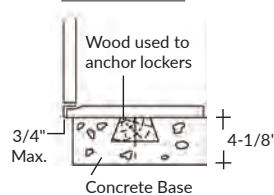

Top View of 3" Vertical Trim R.H.

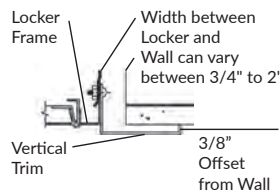

Side View of Top Recessed Trim

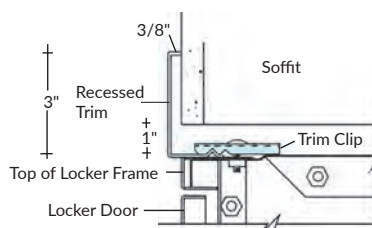

Top View of a Recessed Locker Grouping

Recessed Opening = Length of Locker Group (w/growth) + 3"

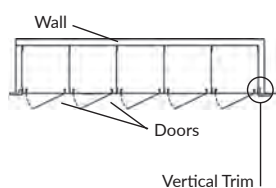

Accessories

Locking System Options

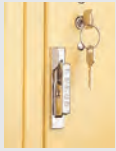

Built-in Key Locks

Available in flat key or grooved key models. Dead bolt and spring bolt construction. Reversible for LH & RH applications.



Built-in Combination Locks

Available with five combination changes for security year to year. Master key controlled. Stainless steel escutcheon plate. Use dead bolt models for all but box lockers, which use spring bolt. Available in LH & RH.

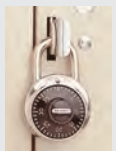

Combination Padlocks

Available with and without master keying. 3 number dialing. Rust resistant. Fits box lockers, Die-Cast Handles, recessed handles, and cremone handles.

Note: For proper fit and security, padlock shackle must have a diameter of 9/32" or 5/16" and a distance of .75" to .81" between the top of the case and the underside of the shackle when in the locked position.



Coin Operated

Ideal for public or private applications that require security with the assurance that keys will be returned, or as a revenue producer. Fits most Penco lockers. Available in 2 types:

coin return and coin collect operation. Not available for Defiant lockers.

ADA Compliant Locks



Key Lock Model No. 9707

Just insert key (turning not required) and lift latch pull to open door.

Key Lock Model No. 9676A

Has an oversized keyhead to facilitate turning.

Benches and Pedestals

A natural accessory for any locker room. Benches add permanent comfort and order to the floor plan arrangement.

Penco offers a choice of bench pedestal styles. Order two pedestals for standard benches 96" long or less; order three pedestals for benches over 96" long. The seat portion of ADA benches require a minimum of 4 pedestals, placed as shown in the photo of the Bench Bracket.

Hardwood Bench Tops

Exceptionally strong wood locker room benches finished with clear lacquer. For ADA (Americans With Disabilities Act) compliant benches, use 16" or 18" deep bench backs and 20" or 24" deep seats plus Bench Brackets to support the backs. Order Pedestals separately.

Bench Tops			
Unit Width	Unit Depth	Unit Thickness	Cat. No.
Standard Bench Tops			
36"	9-1/2"	1-1/4"	9611
48"	9-1/2"	1-1/4"	9600
48"	12"	1-1/4"	9622
60"	9-1/2"	1-1/4"	9601
72"	9-1/2"	1-1/4"	9602
84"	9-1/2"	1-1/4"	9603
96"	9-1/2"	1-1/4"	9604
108"	9-1/2"	1-1/4"	9605
120"	9-1/2"	1-1/4"	9606
132"	9-1/2"	1-1/4"	9607
144"	9-1/2"	1-1/4"	9608
ADA Compliant Benches			
42"	16"	1-1/4"	9634
48"	16"	1-1/4"	9635
42"	18"	1-1/4"	9625
48"	18"	1-1/4"	9628
42"	20"	1-1/4"	9636
48"	20"	1-1/4"	9632
42"	24"	1-1/4"	9624
48"	24"	1-1/4"	9623

B. Stainless Steel Free Standing Pedestal

This pedestal has a 14" wide base which allows for moveable free standing use. Holes in the bottom are provided for optional floor anchoring or for attachment of non-skid bumpers (see below). Hardware is supplied for fastening to the bench top. Height is 16-1/4". Cat. No. 60827H each.

Non-Skid Pedestal Kit for Stainless Steel Pedestal

Rubber non-skid bumpers to prevent damage to floors. Consists of non marking rubber feet and fastening hardware. Order 1 kit per pedestal. Cat. No. 68420

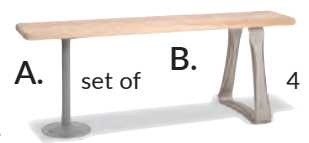

Bench Bracket for Back of ADA Benches

For attaching 16" or 18" backrest to 20" or 24" deep benches for ADA use. Sturdy steel construction. Order a minimum of 2 per back. Size is 19" x 19" x 2". Hardware included. Cat. No. 6ACXHP61H

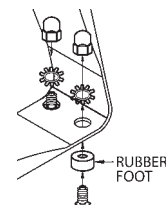

Mirror

Made of acrylic plastic that will not break in normal usage. Mirror has an adhesive backing for easy installation. Size is 6" wide x 8" high. Cat. No. 96370

Fire Extinguisher Door and Waste Bin Door



Lockers can be designated to contain a fire extinguisher door and/or a waste receptacle. The opening on the fire extinguisher door is glazed with wire-reinforced glass.

Waste bin doors have a cut-out with an internal flap and a top spring-loaded hinge to keep the opening closed when not being used. There is a small metal chute inside the door to direct the waste to a waste container (container is not included).

These items are typically ordered in 12" or 15" wide 1 and 2 tier lockers. If recessed handles are used, the width must be a minimum of 15" wide. Locks should not be used on fire extinguisher doors or waste bin doors.

Food Industry Lockers

For ease of cleaning beneath lockers. Leg extensions increase the 6" height to 16". Order as piece parts or in a kit specially designed for 18" deep lockers. Kits include supports for a hardwood bench (order bench separately). Lockers must have standard 6" legs. Not for use with Welded Gen2, Stadium, or Patriot lockers.



Food Industry Locker Conversion			
Unit Width	Unit Depth	Unit Height	Cat. No.
Kits, 18" Depth			
1 Wide	-	16"	64001
3 Wide	-	16"	64003
Rear Leg			
-	-	16"	65540H
Bench Support			
-	18"	-	65541H
End Front Leg			
-	-	16"	65542H
Intermediate Front Leg			
-	-	16"	65543H

Vanguard™ Lockers (Knocked Down)

PART 1 – GENERAL

1.01 SECTION INCLUDES

Standard Knocked Down Lockers

1.02 REFERENCES

ADAAG - Americans with Disabilities Act, Accessibility Guidelines.

1.03 SUBMITTALS

Submit under provisions of Section 01 33 00. Shop Drawings shall show dimensioned plans, elevations, and sections.

1.04 DELIVERY, STORAGE AND HANDLING

Store products in manufacturer's unopened packaging until ready for installation to protect the locker finish and adjacent surfaces from damage.

PART 2 – PRODUCTS

2.01 MANUFACTURER

Penco Products, Inc. or approved equal based upon ability to provide product compliant with specifications of the product selected. Provide only metal lockers fabricated in the United States by a single domestic manufacturer.

2.02 MATERIALS

Steel: All Penco standard lockers are constructed using prime grade mild cold-rolled sheet steel free from surface imperfection meeting ASTM A1008 and capable of taking a high-grade enamel powder coat finish. Alternate material: Sheet steel components shall be fabricated using zinc-coated steel meeting ASTM A879 and finished in the same manner. Forged steel coat hooks with balled ends and truss fin head bolts and hex nuts will be zinc coated and supplied for all lockers unless otherwise indicated.

Greenguard: Lockers shall be GREENGUARD Gold Certified by UL Environment through the GREENGUARD Certification Program.

2.03 STANDARD LOCKERS

Acceptable Product: Penco Vanguard, knock-down lockers. Tops, Bottoms, Backs, Sides, and Shelves fabricated from 24 gauge sheet steel. Locker doors measuring less than 12 inches wide are 18 gauge steel. All others are fabricated from 16 gauge sheet steel. 6 inch legs are standard and can be deleted as a no cost option.

Door Frame: Channel shape, not less than 16 gauge steel. Provide vertical door frame members with additional 3/8 inch (9.5 mm) flange as a continuous door strike. Intermediate cross frame members are standard on double and triple tier lockers.

Multi-Point Latch Doors: One piece sheet steel with full channel formation of

adequate depth to fully conceal lock bar on lock side, channel formation on hinge side, right angle formations across top and bottom, with holes for attaching number plates. Doors over 15 inches wide by 60 inches or 72 inches high will include a 3 inch wide 20 gauge full height reinforcing pan welded to inside face of door at 6 inch centers.

Box Lockers: One piece sheet steel with channel formations on lock and hinge sides, right angle flanges on top and bottom; pre-punch doors for padlock latch and friction catch and built-in combination and key locks.

Ventilation: Provide louvered doors in manufacturer's standard louver pattern.

Hinges: Two inch high, double spun, full loop, tight pin, projection welded to door frame and securely fastened to the door with steel rivets. Provide three 2 inch five-knuckle hinges on doors over 48 inches high and two 2 inch high five-knuckle hinges on all other doors.

2.04 DOOR HANDLES AND LATCHING

Two Person and Duplex Lockers, 1, 2 and 3 Tier featuring multi-point latching:

Recessed Handle: Classic III Multi-point latching with recessed handle activated by a finger-lift control handle in a drawn and brushed stainless steel pocket fastened to the door with two tabs and a positive tamper-resistant decorative fastener. Depth shall be sufficient to prevent a standard combination padlock, built-in combination lock, or key lock from protruding beyond door face. Nylon lift trigger accommodates use of 9/32 inch padlock.

Die-Cast Handle: Chrome-plated zinc alloy die-cast case and handle attached to latch bar concealed inside door and tamperproof. Pulling handle out shall move latch bar up and open door in one motion and providing for use of 9/32 inch diameter padlock, integral with handle and located so that extension of handle forms padlock strike. Doors over 48 inches high shall use glass-filled nylon clips to engage the door frame and hold the door shut at three points. All other doors engage at two points.

Locking Device: Positive, automatic type, whereby locker may be locked when open, then closed without unlocking. Firmly secure one rubber silencer in frame at each latch hook.

Box Lockers (3 to 6 Tier): Punch doors for use with padlocks or built-in locks and configure doors for use with padlocks with an 18 gauge combination door pull, staple, and lock hole cover plate with integral friction catch.

2.05 INTERIOR EQUIPMENT

ADA-Compliant Lockers (Recessed Handles with Multi-Point Latch): Single Tier: Hat shelf 48 inches from locker bottom or lower as required by base condition. Double Tier: Only bottom opening, a shelf placed 15 inches off the floor or lower as required by base condition.

2.07 FABRICATION

Fabrication shall be on the unit principle, each locker with individual door and frame, individual top, bottom, back, and shelves, with common intermediate divisions separating compartments.

Finish: High quality powder coat paint finish applied in strict adherence to paint manufacturer's specifications to provide optimum appearance and performance. Finishes releasing VOCs are not acceptable. Standard coating thickness is 1 mil dry film thickness minimum. Powder Coat Plus option increases thickness to 2 mil minimum. Colors as selected from manufacturer's standard colors.

Alternative finishes: Custom color match, Anti-Graffiti or Anti-Microbial finishes are available.

PART 3 – EXECUTION

3.01 EXAMINATION

Do not begin installation until substrates and bases have been properly prepared. If substrate and bases are the responsibility of another installer, notify Architect of unsatisfactory preparation before proceeding.

3.02 INSTALLATION

Install metal lockers and accessories at locations shown in accordance with manufacturer's instructions. Install lockers plumb, level, and square. Anchor lockers to floor and wall at intervals recommended by the manufacturer. Bolt adjoining locker units together to provide rigid installation.

3.03 ADJUSTING

Adjust doors and latches to operate without binding. Verify that latches are operating satisfactorily. Adjust built-in locks to prevent binding of dial or key and ensure smooth operation prior to substantial completion.

Touch-up with factory-supplied paint and repair or replace damaged products before substantial completion.

3.04 PROTECTION

Protect installed products until completion of project.

Full MasterFormat Specifications can be found on pencoproducts.com.

Guardian™ Lockers (Knocked Down)

PART 1 – GENERAL

1.01 SECTION INCLUDES

Standard Knocked Down Lockers

1.02 REFERENCES

ADAAG - Americans with Disabilities Act, Accessibility Guidelines.

1.03 SUBMITTALS

Submit under provisions of Section 01 33 00. Shop Drawings shall show dimensioned plans, elevations, and sections.

1.04 DELIVERY, STORAGE, AND HANDLING

Store products in manufacturer's unopened packaging until ready for installation to protect the locker finish and adjacent surfaces from damage.

PART 2 – PRODUCTS

2.01 MANUFACTURER

Penco Products, Inc. or approved equal based upon ability to provide product compliant with specifications of the product selected. Provide only metal lockers fabricated in the United States by a single domestic manufacturer.

2.02 MATERIALS

Steel: All Penco standard lockers are constructed using prime grade mild cold-rolled sheet steel free from surface imperfection meeting ASTM A1008 and capable of taking a high-grade enamel powder coat finish. Alternate material: Sheet steel components shall be fabricated using zinc-coated steel meeting ASTM A879 and finished in the same manner. Forged steel coat hooks with balled ends and truss fin head bolts and hex nuts will be zinc coated and supplied for all lockers unless otherwise indicated.

Greenguard: Lockers shall be GREENGUARD Gold Certified by UL Environment through the GREENGUARD Certification Program.

2.03 STANDARD LOCKERS

Acceptable Product: Penco Guardian, knock-down lockers. Tops, Bottoms, Backs, Sides, and Shelves fabricated from 24 gauge sheet steel. Locker doors measuring less than 12 inches wide are 18 gauge steel. All others are fabricated from 16 gauge sheet steel. 6 inch legs are standard and can be deleted as a no cost option.

Door Frame: Channel shape, not less than 16 gauge steel. Provide vertical door frame members with additional 3/8 inch (9.5 mm) flange as a continuous door strike. Intermediate cross frame members are standard on double and triple tier lockers.

Multi-Point Latch Doors: One piece sheet steel with full channel formation of adequate depth to fully conceal lock bar on lock side, channel formation on hinge side, right angle formations across top and bottom, with holes for attaching number plates. Doors over 15 inches wide by 60 inches or 72 inches high will include a 3 inch wide 20 gauge full height reinforcing pan welded to inside face of door at 6 inch centers.

Ventilation: Flush door front with no exposed louvers and air flow slots located in top and bottom flanges of door.

Hinges: Two inch high, double spun, full loop, tight pin, projection welded to door frame and securely fastened to the door with steel rivets. Provide three 2 inch five-knuckle hinges on doors over 48 inches high and two 2 inch high five-knuckle hinges on all other doors.

2.04 DOOR HANDLES AND LATCHING Two Person and Duplex Lockers, 1, 2 and 3 Tier Featuring Multi-point Latching:

Classic III Multi-point latching with recessed handle activated by a finger-lift control handle in a drawn and brushed stainless steel pocket fastened to the door with two tabs and a positive tamper-resistant decorative fastener. Depth shall be sufficient to prevent a standard combination padlock, built-in combination lock, or key lock from protruding beyond door face. Nylon lift trigger accommodates use of 9/32 inch padlock. Doors over 48 inches high shall use glass-filled nylon clips to engage the door frame and hold the door shut at three points. All other doors engage at two points.

Locking Device: Positive, automatic type, whereby locker may be locked when open, then closed without unlocking. Firmly secure one rubber silencer in frame at each latch hook.

2.05 INTERIOR EQUIPMENT

ADA-Compliant Lockers: Single Tier: Hat shelf 48 inches from locker bottom or lower as required by base condition. Double Tier: Only bottom opening, a shelf placed 15 inches off the floor or lower as required by base condition.

2.06 FABRICATION

Fabrication shall be on the unit principle, each locker with individual door and frame, individual top, bottom, back, and shelves, with common intermediate divisions separating compartments.

Finish: High quality powder coat paint finish applied in strict adherence to paint manufacturer's specifications to provide optimum appearance and performance.

Finishes releasing VOCs are not acceptable. Standard coating thickness is 1 mil dry film thickness minimum. Powder Coat Plus option increases thickness to 2 mil minimum. Colors as selected from manufacturer's standard colors.

Alternative finishes: Custom color match, Anti-Graffiti or Anti-Microbial finishes are available.

PART 3 – EXECUTION

3.01 EXAMINATION

Do not begin installation until substrates and bases have been properly prepared. If substrate and bases are the responsibility of another installer, notify Architect of unsatisfactory preparation before proceeding.

3.02 INSTALLATION

Install metal lockers and accessories at locations shown in accordance with manufacturer's instructions. Install lockers plumb, level, and square. Anchor lockers to floor and wall at intervals recommended by the manufacturer. Bolt adjoining locker units together to provide rigid installation.

3.03 ADJUSTING

Adjust doors and latches to operate without binding. Verify that latches are operating satisfactorily. Adjust built-in locks to prevent binding of dial or key and ensure smooth operation prior to substantial completion.

Touch-up with factory-supplied paint and repair or replace damaged products before substantial completion.

3.04 PROTECTION

Protect installed products until completion of project.

DOOR OPTIONS

Guardian Medallion: Doors will include sound-deadening material enclosed in a 3 inch wide partial height pan welded to inside face of door.

Guardian Plus: Locker doors are fabricated from 14 gauge sheet steel.

Penco Products, Inc. reserves the right to vary specifications consistent with a policy of continuous product improvement.

Full MasterFormat Specifications can be found on pencoproducts.com.

Invincible II™ Lockers (Knocked Down)

PART 1 - GENERAL

1.01 SECTION INCLUDES

Heavy Duty Knocked Down Lockers

1.02 REFERENCES

ADAAG - Americans with Disabilities Act, Accessibility Guidelines.

1.03 SUBMITTALS

Submit under provisions of Section 01 33 00. Shop Drawings shall show dimensioned plans, elevations, and sections.

1.04 DELIVERY, STORAGE, AND HANDLING

Store products in manufacturer's unopened packaging until ready for installation to protect the locker finish and adjacent surfaces from damage.

PART 2 - PRODUCTS

2.01 MANUFACTURER

Penco Products, Inc. or approved equal based upon ability to provide product compliant with specifications of the product selected. Provide only metal lockers fabricated in the United States by a single domestic manufacturer.

2.02 MATERIALS

Steel: All Penco standard lockers are constructed using prime grade mild cold-rolled sheet steel free from surface imperfection meeting ASTM A1008 and capable of taking a high-grade enamel powder coat finish. Alternate material: Sheet steel components shall be fabricated using zinc-coated steel meeting ASTM A879 and finished in the same manner. Forged steel coat hooks with balled ends and truss fin head bolts and hex nuts will be zinc coated and supplied for all lockers unless otherwise indicated.

Greenguard: Lockers shall be GREENGUARD Gold Certified by UL Environment through the GREENGUARD Certification Program.

2.03 HEAVY DUTY LOCKERS

Acceptable Product: Penco Invincible II, knocked-down lockers. Tops, Bottoms, Sides, and Shelves shall be fabricated from 16 gauge and backs from 18 gauge sheet steel. Locker doors shall be 14 gauge. 6 inch legs are standard and can be deleted as a no cost option.

Door Frame: Channel shape, not less than 16 gauge steel. Provide vertical door frame members with additional 3/8 inch (9.5 mm) flange as a continuous door strike. Intermediate cross frame members are standard on double and triple tier lockers.

Multi-Point Latch Doors: One piece sheet steel with full channel formation of adequate depth to fully conceal lock bar on lock side, channel formation on hinge side, right angle formations across top and bottom, with holes for attaching number plates. Doors over 15 inches wide by 60 inches or 72 inches high will include a 3 inch wide 20 gauge full height reinforcing pan welded to inside face of door at 6 inch centers.

Ventilation: Doors and locker sides have standard 3/4 inch (19 mm) wide by 1-1/2 inch (38 mm) high diamond-shaped perforations. Doors less than 20 inches tall have 7/16 inch (11 mm) wide by 15/16 inch (24 mm) high diamond-shaped perforations.

Hinges: Two inch high, double spun, full loop, tight pin, projection welded to door frame and securely fastened to the door with steel rivets. Provide three 2 inch five-knuckle hinges on doors over 48 inches high and two 2 inch high five-knuckle hinges on all other doors.

2.04 DOOR HANDLES AND LATCHING

1, 2 and 3 Tier Featuring Multi-point Latching: Classic III Multi-point latching with recessed handle activated by a finger-lift control handle in a drawn and brushed stainless steel pocket fastened to the door with two tabs and a positive tamper-resistant decorative fastener. Depth shall be sufficient to prevent a standard combination padlock, built-in combination lock, or key lock from protruding beyond door face. Nylon lift trigger accommodates use of 9/32 inch padlock. Doors over 48 inches high shall use glass-filled nylon clips to engage the door frame and hold the door shut at three points. All other doors engage at two points.

Locking Device: Positive, automatic type, whereby locker may be locked when open, then closed without unlocking. Firmly secure one rubber silencer in frame at each latch hook.

4-9 Tier Box Lockers: Punch doors for use with padlocks or built-in locks. Equip doors for use with padlocks with an 18 gauge combination door pull, staple, and lock hole cover plate with integral friction catch.

2.05 INTERIOR EQUIPMENT

ADA-Compliant Lockers: Single Tier: Hat shelf 48 inches from locker bottom or lower as required by base condition. Double Tier: Only bottom opening, a shelf placed 15 inches off the floor or lower as required by base condition.

2.06 FABRICATION

Fabrication shall be on the unit principle, each locker with individual door and frame, individual top, bottom, back, and shelves, with common intermediate divisions separating compartments.

Finish: High quality powder coat paint finish applied in strict adherence to paint manufacturer's specifications to provide optimum appearance and performance. Finishes releasing VOCs are not acceptable. Standard coating thickness is 1 mil dry film thickness minimum. Powder Coat Plus option increases thickness to 2 mil minimum. Colors as selected from manufacturer's standard colors. All locker body components shall match color of door and frame.

Alternative finishes: Custom color match, Anti-Graffiti or Anti-Microbial finishes are available.

PART 3 - EXECUTION

3.01 EXAMINATION

Do not begin installation until substrates and bases have been properly prepared. If substrate and bases are the responsibility of another installer, notify Architect of unsatisfactory preparation before proceeding.

3.02 INSTALLATION

Install metal lockers and accessories at locations shown in accordance with manufacturer's instructions. Install lockers plumb, level, and square. Anchor lockers to floor and wall at intervals recommended by the manufacturer. Bolt adjoining locker units together to provide rigid installation.

3.03 ADJUSTING

Adjust doors and latches to operate without binding. Verify that latches are operating satisfactorily. Adjust built-in locks to prevent binding of dial or key and ensure smooth operation prior to substantial completion.

Touch-up with factory-supplied paint and repair or replace damaged products before substantial completion.

3.04 PROTECTION

Protect installed products until completion of project.

Penco Products, Inc. reserves the right to vary specifications consistent with a policy of continuous product improvement.

Full MasterFormat Specifications can be found on pencoproducts.com.

Welded Gen2™ Lockers

PART 1 - GENERAL

1.01 SECTION INCLUDES

Heavy Duty Welded Lockers

1.02 REFERENCES

ADAAG - Americans with Disabilities Act, Accessibility Guidelines.

1.03 SUBMITTALS

Submit under provisions of Section 01 33 00. Shop Drawings shall show dimensioned plans, elevations, and sections.

1.04 DELIVERY, STORAGE, AND HANDLING

Store products in manufacturer's unopened packaging until ready for installation to protect the locker finish and adjacent surfaces from damage.

PART 2 - PRODUCTS

2.01 MANUFACTURER

Penco Products, Inc. or approved equal based upon ability to provide product compliant with specifications of the product selected. Provide only metal lockers fabricated in the United States by a single domestic manufacturer.

2.02 MATERIALS

Steel: All Penco standard lockers are constructed using prime grade mild cold-rolled sheet steel free from surface imperfection meeting ASTM A1008 and capable of taking a high-grade enamel powder coat finish. Alternate material: Sheet steel components shall be fabricated using zinc-coated steel meeting ASTM A879 and finished in the same manner. Forged steel coat hooks with balled ends and truss fin head bolts and hex nuts will be zinc coated and supplied for all lockers unless otherwise indicated.

Greenguard: Lockers shall be GREENGUARD Gold Certified by UL Environment through the GREENGUARD Certification Program.

2.03 HEAVY DUTY LOCKERS

Acceptable Product: Penco Welded Gen2 lockers. Tops, Bottoms, Sides, and Shelves shall be fabricated from 16 gauge and backs from 18 gauge sheet steel. Locker doors shall be 14 gauge.

Door Frame: Channel shape, not less than 16 gauge steel. Provide vertical door frame members with additional 3/8 inch (9.5 mm) flange as a continuous door strike. Intermediate cross frame members are standard on double and triple tier lockers.

Multi-Point Latch Doors: One piece sheet steel with full channel formation of

adequate depth to fully conceal lock bar on lock side, channel formation on hinge side, right angle formations across top and bottom, with holes for attaching number plates. Doors over 15 inches wide by 60 inches or 72 inches high will include a 3 inch wide 20 gauge full height reinforcing pan welded to inside face of door at 6 inch centers.

Ventilation: Doors and locker sides have standard 3/4 inch (19 mm) wide by 1-1/2 inch (38 mm) high diamond-shaped perforations. Doors less than 20 inches tall have 7/16 inch (11 mm) wide by 15/16 inch (24 mm) high diamond-shaped perforations.

Hinges: Continuous type: 16 gauge piano hinge measuring full height of door. Welded to door and attached to locker frame using steel rivets.

2.04 DOOR HANDLES AND LATCHING

1, 2 and 3 Tier Featuring Multi-point Latching: Classic III Multi-point latching with recessed handle activated by a finger-lift control handle in a drawn and brushed stainless steel pocket fastened to the door with two tabs and a positive tamper-resistant decorative fastener. Depth shall be sufficient to prevent a standard combination padlock, built-in combination lock, or key lock from protruding beyond door face. Nylon lift trigger accommodates use of 9/32 inch padlock. Doors over 48 inches high shall use glass-filled nylon clips to engage the door frame and hold the door shut at three points. All other doors engage at two points.

Locking Device: Positive, automatic type, whereby locker may be locked when open, then closed without unlocking. Firmly secure one rubber silencer in frame at each latch hook.

4-9 Tier Box Lockers: Punch doors for use with padlocks or built-in locks. Equip doors for use with padlocks with an 18 gauge combination door pull, staple, and lock hole cover plate with integral friction catch.

2.05 INTERIOR EQUIPMENT

ADA-Compliant Lockers (Recessed Handles with Multi-Point Latch): Single Tier: Hat shelf 48 inches from locker bottom or lower as required by base condition. Double Tier: Only bottom opening, a shelf placed 15 inches off the floor or lower as required by base condition.

2.06 FABRICATION

Pre-assemble lockers by welding into one piece structures in groupings most practical for job requirements, welds free of burrs; maximum width of group to be

54 inches (1.371 m); no bolts, nuts, or rivets allowed in assembly of main locker groups.

Finish: High quality powder coat paint finish applied in strict adherence to paint manufacturer's specifications to provide optimum appearance and performance. Finishes releasing VOCs are not acceptable. Standard coating thickness is 1 mil dry film thickness minimum. Powder Coat Plus option increases thickness to 2 mil minimum. Colors as selected from manufacturer's standard colors. All locker body components shall match color of door and frame.

Alternative finishes: Custom color match, Anti-Graffiti or Anti-Microbial finishes are available.

PART 3 - EXECUTION

3.01 EXAMINATION

Do not begin installation until substrates and bases have been properly prepared. If substrate and bases are the responsibility of another installer, notify Architect of unsatisfactory preparation before proceeding.

3.02 INSTALLATION

Install metal lockers and accessories at locations shown in accordance with manufacturer's instructions. Install lockers plumb, level, and square. Anchor lockers to floor and wall at intervals recommended by the manufacturer. Bolt adjoining locker units together to provide rigid installation.

3.03 ADJUSTING

Adjust doors and latches to operate without binding. Verify that latches are operating satisfactorily. Adjust built-in locks to prevent binding of dial or key and ensure smooth operation prior to substantial completion.

Touch-up with factory-supplied paint and repair or replace damaged products before substantial completion.

3.04 PROTECTION

Protect installed products until completion of project.

Penco Products, Inc. reserves the right to vary specifications consistent with a policy of continuous product improvement.

Full MasterFormat Specifications can be found on pencoproducts.com.

Steel Locker Accessories

(Welded Gen2, Vanguard, Guardian, and Invincible II)

Closed Bases: Provide 18 gauge closed metal front and end bases on knocked down lockers having legs. Front bases shall be installed between legs without overlap or exposed fasteners. Provide end bases on exposed ends. Bases shall be finished to match lockers.

Locks: (Specify lock brand if desired, location and locker type if appropriate.) All locks shall have bolt types appropriate to the mode of locker operations.

Built-In Flat Key Locks: Lockers shall be equipped with built-in flat key type locks. All locks shall be master keyed to the same series. Provide two (2) keys for each lock and two (2) master keys for the system.

Built-In Grooved Key Locks (Pin Tumbler): Lockers shall be equipped with built-in grooved key type locks. All locks shall be master keyed to the same series. Provide two (2) keys for each lock and two (2) master keys for the system.

Built-in Combination Locks: Lockers shall be equipped with built-in combination locks. Locks shall have three-number combination dialing and be capable of at least five different combination changes. Master key, combination change key, if required, and combination control charts shall be provided to the owner.

Padlocks-Combination Type: Master keyed combination type padlocks shall be provided for all locker doors. Locks shall have three-number combination dialing. Master key shall be provided to the owner.

Coin Operated Locks: (Certain locker types and sizes will not accept coin locks; verify with locker manufacturer). Coin operated locks shall be provided for lockers. Locks shall be (select one): Coin return/deposit type; Coin collect/pay type; Coin fee shall be (select one): One (1) Quarter; Two (2) Quarters. Locks are to be installed on lockers using security-type machine screws.

Visual Perforation 16 Ga. & 18 Ga.: Locker doors shall be provided with 5/8" x 1-1/8" rectangular visual perforations.

Round Perforation: 24 gauge (Backs, Sides, Tops, Bottoms or Shelves) are to be

punched with 1/2" diameter perforations grouped in 42 hole patterns. (For sides and backs, specify full perforations for maximum number of holes in the part, or standard perforations consisting of one group top and bottom in single-tier; one group each compartment in double-tier or box lockers).

Fire Extinguisher Door: Lockers designated on drawings to contain fire extinguisher shall be double tier type with upper door to have a glazed opening. Locks are to be omitted on fire extinguisher doors.

Waste Bin Doors: Lockers designated on drawings to contain waste bins shall be provided with a door cut-out with a top hinged internal flap door over the cut-out. Locks are to be omitted on waste bin doors.

Center Partitions: Lockers shall have 24 gauge, full depth, vertical partitions between bottom and shelf.

Recess Trim: Vertical and/or horizontal recessed trim shall be provided where shown. Trim shall be formed from 18 gauge sheet steel and have a 3" face dimension. Trim shall be furnished in standard lengths as long as practical and attached to lockers with concealed clips. Finish caps and splices shall be provided as required. Trim shall be finished to match lockers.

Zee Bases: Knocked down lockers shall be furnished with 4" high or 6" high 14 gauge zee base flanged outward at top for support of lockers and inward at bottom for anchoring to the floor. Not for use for Stadium and Welded Lockers.

Front Filler: Fillers for spaces between lockers or between lockers and a wall shall be fabricated from 20 gauge sheet steel and formed in an angle shape. Slip joint angles shall be 20 gauge sheet steel formed in an angle shape with a slot on one leg to form a pocket which provides adjustable mating with the angle filler. Attachment shall be by means of concealed fasteners. Fillers shall be finished to match lockers.

Exposed Locker Sides: Shall be furnished in 16 gauge without any extra holes.

Boxed Finished End Panels: Boxed finished end panels shall be installed on all exposed ends of lockers. They shall be formed from minimum 16 gauge sheet steel to match locker depth and height, and shall have a 1" edge dimension. All panels shall be installed with concealed fasteners. Panels shall be finished to match lockers.

Continuous Slope Hood: Lockers shall be provided with continuous slope hoods formed from 18 gauge sheet steel with a slope that has a rise equal to 1/3 of the locker depth (18-1/2"), plus a 1" vertical rise at the front. Tops shall be provided in lengths as long as practical. Provide slip joints without visible fasteners at splice locations. Necessary end closures shall be provided. Tops shall be finished to match lockers.

Unit Slope Tops Vanguard and Guardian Lockers: Lockers shall be provided with 24 gauge individual sloping tops. Tops shall be formed to a slope which rises 1/3 of the locker depth. Tops shall be finished to match lockers.

Benches: Locker benches shall be laminated selected hardwood, 1-1/4" full finished thickness. All corners are to be rounded and sanded. Surfaces shall be finished with two coats of clear lacquer. Bench tops are to be 9-1/2" wide and furnished in lengths of 3' through 12' (even foot increments).

Heavy Duty Bench Pedestal: Pedestals shall consist of steel tubing with 11 gauge steel flanges welded to each end. The overall height of pedestal shall be 16-1/4". Pedestals are to be finished to match the lockers.

Stainless Steel Free Standing Bench Pedestal: Shall be 2" diameter brushed 16 ga. stainless steel formed into a trapezoid. Bottom shall be 14" wide with two 5/16" diameter holes. Pedestal shall be 16-1/4" high for an overall bench height of 17-1/2". Top flange shall have four 5/16" diameter holes for fastening to the bench. Bench can be moveable or may be anchored.

Specifications



Defiant II™ Single Point Latch Lockers

When specifying Guardian, Welded Gen2, Invincible II, Angle Iron or Patriot® lockers with Defiant II Single Point Latch doors, substitute the following specifications for the "Door Handle & Latching ..." section referring to 1-tier to 3-tier doors.

Doors: All doors shall be formed from 14 gauge steel. Formations shall be channel shape on the hinge and latch sides, and right angle formations across the top and bottom. Top and bottom flanges shall have one 90 degree bend. The latch side formation shall include a slot to fully engage an additional anti-pry lug integral with the padlock hasp limiting motion in any direction. On doors measuring 12" through 18" wide, additional reinforcement shall be in the form of a vertical 18 gauge pan measuring 3-1/2" wide MIG-welded to the top and bottom flanges and hinge side channel, with an additional 1/2" flange spot welded a maximum of 8" on center to the door skin to maximize door rigidity. Doors measuring more than 18" wide shall be reinforced using a 20 gauge horizontal box pan MIG-welded a maximum of 8" on center to the hinge and latch side channels, and spot welded to the door skin a maximum of 8" on center along the upper and lower pan edge for optimum strength, quiet operation and stiffness. Door shall be manufactured to allow ventilation and stiffness.

Hinge: 16 gauge continuous hinges (full length of the door) are welded to the door and riveted to the frame.

Door Handle & Latching 1, 2 & 3 Tier: Handles shall be recessed in the door. The formed pocket shall be brushed stainless steel securely fastened to the door with two lugs plus a positive tamper resistant fastener. The pocket shall be of sufficient depth to prevent a combination padlock, built-in combination lock or key lock from protruding beyond the face of the door. An anti-pry lock alignment bracket shall be supplied for use with built-in combination locks to facilitate installation, adjustment and to increase resistance to prying by mechanically engaging the hasp assembly. A lock hole cover plate shall be provided for use with padlocks. All pockets shall be drawn stainless steel for superior strength. Door pull shall be formed in the pocket. Pocket and pull shall be integral. Doors shall have a catch to retain unlocked doors in the closed position. Locking shall be accomplished by an 11 gauge lug welded to the locker frame. The lug shall include a surface for the bolt of a built-in combination or key lock to engage. A padlock staple shall protrude through the pocket. The hasp assembly shall include an additional lug that mechanically engages a slot on the latch side door formation preventing the spreading of the door from the frame channel. A separate bracket shall be field installed to brace the lock hasp assembly against the locker side to prevent twisting of the frame. Rubber door silencers shall be firmly attached to the locker frame.

Penco Products, Inc. reserves the right to vary specifications consistent with a policy of continuous product improvement.

Full MasterFormat Specifications can be found on pencoproducts.com.

Defiant II 1-tier lockers with built-in combination locks, finished end panels and custom flat tops.

The Single Point Alternative

- Greater tamper resistance
- Increased rigidity
- Improved Performance with built-in locks

The Defiant II Single Point Latch (SPL) option is for those desiring a heavy gauge door offering improved security with the low maintenance inherent in a door with no moving parts.

Each door has a patented deep drawn stainless steel pocket handle with an integral door pull. The doors can be locked with a conventional padlock, using the padlock staple protruding through the recessed handle (recommended) or with a built-in lock.

Doors are stiffened with either a vertical or horizontal pan, as shown at the right.

Doors that have any type of perforations including louvers will require the perforations/louvers to be modified from the standard patterns and sizes to allow for either type of pan to be used. Contact a Penco representative for details.

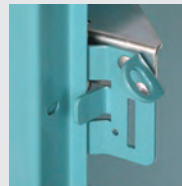

For KD Lockers



For Welded Lockers



Vertical Pan



Horizontal Pan



Anti-Pry/Lock Alignment Bracket

Defeats prying attempts by capturing the door flange and preventing separation from the door channel.



Side Stiffener

This full-depth stiffener prevents frame channel and side-sheet torquing during break-in attempts. For use at left ends of 24 gauge Guardian K.D. bodies of 1 & 2 tier lockers with combination locks only.



Defiant II 2-tier Welded Gen2 lockers with slope hoods, boxed finished end panels and custom bases & benches.



Fully Framed Stadium™ Lockers (Knocked Down)

PART 1 – GENERAL

1.01 SECTION INCLUDES

Heavy Duty Knocked Down Fully Framed Stadium Open Front Lockers

1.02 REFERENCES

ADAAG - Americans with Disabilities Act, Accessibility Guidelines.

1.03 SUBMITTALS

Submit under provisions of Section 01 33 00. Shop Drawings shall show dimensioned plans, elevations, and sections. For each product specified, two complete sets of color chips representing manufacturer's full range of available colors and finishes.

1.04 DELIVERY, STORAGE AND HANDLING

Store products in manufacturer's unopened packaging until ready for installation to protect the locker finish and adjacent surfaces from damage.

PART 2 – PRODUCTS

2.01 MANUFACTURER

Acceptable Manufacturer is Penco Products, Inc. which is located at 1820 Stonehenge Dr., Greenville, NC 27858.

Lockers shall be GREENGUARD Gold Certified by UL Environment through the GREENGUARD Certification Program.

2.02 MATERIALS

Steel: All Penco standard lockers are constructed using prime grade steel free from surface imperfection capable of taking high grade enamel finish. Sheet steel components shall be zinc coated and free from surface imperfection and capable of taking high grade enamel finish. 13 gauge Expanded Metal Divisions that meet or exceed ASTM A1008/A1008M captured on all sides by the tubular shaped frame assembly. Self-tapping screws and rivets. Provide only metal lockers that conform to Made in US regulations.

2.03 HEAVY DUTY OPEN FRONT PERSONAL EQUIPMENT LOCKERS

Heavy Duty Lockers: All locker body components made of cold rolled steel specially formed for added strength and rigidity and to ensure tight joints at fastening points.

Locker Body Construction: Steel specially formed for added strength and rigidity and to ensure tight joints at fastening points. Bottoms, tops and shelves made from 16 gauge steel. Sides are either 16 gauge solid or will be 16 gauge with diamond perforations (on 72 inch high only). Backs are solid 18 gauge steel; one piece. Tops and bottoms with four sides formed at 90 degrees, welded to the fully framed channel with cast corner pieces. Channel Base

is 4 inches or 6 inches high, made from 14 gauge sheet forming a "C" channel attached to locker bottom. Shelves with four sides formed to 90 degrees, front and back edge having a second bend. Locker body is tubular frame construction with cast steel interlocks to provide a true fully framed locker body construction. Hole spacing in locker body not exceeding 3 inches. Optional factory assembly of lockers (welded version only).

2.04 INTERIOR EQUIPMENT

Heavy Duty Fully Framed Stadium Lockers Without Doors: Shelf located approximately 13 inches (330 mm) below top of locker. Hooks- two heavy duty single prong hooks with a diameter of 0.276 inches, mounted to shelf and designed to accept a coat rod and two single prong hooks with a diameter of 0.187 inches in rear, mounted to shelf.

Interior Equipment Options: Optional security box; 16 gauge lockable door with a 16 gauge side panel. The door is attached to the welded frame of the security box using a two-point hinge. The door is locked through a single point latch with a padlock or built in lock. A door pull shall be provided for use with padlocks. Security box door frame to be not less than 16 gauge formed to a channel shape. Vertical members to have an additional flange to provide a continuous door strike. 9 inch wide security box on 18 inch wide Stadium locker and 12 inch wide security box on 24 inch wide Stadium locker. Optional footlocker; recessed from locker frame. Front foot locker panel includes single point latch with padlock strike plate and vertical slots. 14 gauge lid of footlocker has a continuous hinge and also serves as a seat. Opening and closing of the lid is quieted by rubber bumpers mounted to the contact points. The seat lid is strengthened with two reinforcement channels welded to bottom. Lid/seat is supported by mounting side rails attached to the vertical posts. Optional coat rods using coat rod hooks mounted to shelf.

2.05 ACCESSORIES

(See Full Product Specifications)

2.06 FABRICATION

Fabricate lockers with fully framed construction, 8 male/female insertion points to provide the fully framed locker body, square, rigid, without warp, with metal faces flat and free of distortion. Fabricated on the unit principle, each locker with individual door and frame, individual top, bottom, back and shelves. Verify dimensions and arrangement before fabrication.

Finish: Enamel powder coat paint finish electrostatically applied and properly cured to manufacturer's specifications for optimum performance. Finishes releasing VOC's and subject to out-gassing are not acceptable. Locker exterior and interior shall be painted the same color. Standard coating thickness is 1 to 1.2 mils (0.025 to 0.03 mm) dry film thickness minimum. Powder Coat Plus option is 2 to 2.2 mils (.05 to .055 mm). Colors as selected from manufacturer's standard colors.

Alternative finishes: Custom color match, Anti-Graffiti or Anti-Microbial finishes are available.

PART 3 – EXECUTION

3.01 EXAMINATION

Do not begin installation until substrates and bases have been properly prepared. If substrate and bases are the responsibility of another installer, notify Architect of unsatisfactory preparation before proceeding.

3.02 INSTALLATION

Install metal lockers and accessories at locations shown in accordance with manufacturer's instructions. Install lockers plumb, level, and square. Work is not to progress until site meets necessary conditions. Anchor lockers to floor and wall at intervals of 36 inches (0.914 m) or less, as recommended by manufacturer. Bolt adjoining locker units together to provide rigid installation. Install sloping tops and metal fillers using concealed fasteners. Provide flush hairline joints against adjacent surfaces. Install benches by fastening bench tops to pedestals and securely anchoring to the floor using appropriate anchors for the floor material.

3.03 ADJUSTING

Adjust doors and latches to operate without binding. Verify that latches are operating satisfactorily. Adjust built-in locks to prevent binding of dial or key and ensure smooth operation prior to substantial completion.

Touch-up with factory-supplied paint and repair or replace damaged products before substantial completion.

3.04 PROTECTION

Protect installed products until completion of project.

Fully Framed Stadium™ Lockers (Welded)

PART 1 - GENERAL

1.01 SECTION INCLUDES

Heavy Duty Welded Fully Framed Stadium Open Front Lockers

1.02 REFERENCES

ADAAG - Americans with Disabilities Act, Accessibility Guidelines.

1.03 SUBMITTALS

Submit under provisions of Section 01 33 00. Shop Drawings shall show dimensioned plans, elevations, and sections. For each product specified, two complete sets of color chips representing manufacturer's full range of available colors and finishes.

1.04 DELIVERY, STORAGE AND HANDLING

Store products in manufacturer's unopened packaging until ready for installation to protect the locker finish and adjacent surfaces from damage.

PART 2 - PRODUCTS

2.01 MANUFACTURER

Acceptable Manufacturer is Penco Products, Inc. which is located at 1820 Stonehenge Dr., Greenville, NC 27858.

Lockers shall be GREENGUARD Gold Certified by UL Environment through the GREENGUARD Certification Program.

2.02 MATERIALS

Steel: All Penco standard lockers are constructed using prime grade steel free from surface imperfection capable of taking high grade enamel finish. Sheet steel components shall be zinc coated and free from surface imperfection and capable of taking high grade enamel finish. 13 gauge Expanded Metal Divisions that meet or exceed ASTM A1008/A1008M captured on all sides by the tubular shaped frame assembly. Self-tapping screws and rivets. Provide only metal lockers that conform to Made in US regulations.

2.03 HEAVY DUTY OPEN FRONT PERSONAL EQUIPMENT LOCKERS

Heavy Duty Lockers: All locker body components made of cold rolled steel specially formed for added strength and rigidity and to ensure tight joints at fastening points.

Locker Body Construction: Welded Shell. Steel specially formed for added strength and rigidity and to ensure tight joints at fastening points. Bottoms, tops and shelves made from 16 gauge steel. Sides are either 16 gauge solid or will be 16 gauge with diamond perforations (on 72 inch high only). Backs are solid 18 gauge steel; one piece. Tops and bottoms with four

sides formed at 90 degrees, welded to the fully framed channel with cast corner pieces. Channel Base is 4 inches or 6 inches high, made from 14 gauge sheet forming a "C" channel attached to locker bottom. Shelves with four sides formed to 90 degrees, front and back edge having a second bend. Locker body is welded shell with tubular framed construction with cast steel interlocks to provide a true fully framed locker body construction. Hole spacing in locker body not exceeding 3 inches. Factory assembly of lockers.

2.04 INTERIOR EQUIPMENT

Heavy Duty Fully Framed Stadium Lockers Without Doors: Shelf located approximately 13 inches (330 mm) below top of locker. Hooks- two heavy duty single prong hooks with a diameter of 0.276 inches, mounted to shelf and designed to accept a coat rod and two single prong hooks with a diameter of 0.187 inches in rear, mounted to shelf.

Interior Equipment Options: Optional security box; 16 gauge lockable door with a 16 gauge side panel. The door is attached to the welded frame of the security box using a two-point hinge. The door is locked through a single point latch with a padlock or built in lock. A door pull shall be provided for use with padlocks. Security box door frame to be not less than 16 gauge formed to a channel shape. Vertical members to have an additional flange to provide a continuous door strike. 9 inch wide security box on 18 inch wide Stadium locker and 12 inch wide security box on 24 inch wide Stadium locker. Optional footlocker; recessed from locker frame. Front foot locker panel includes single point latch with padlock strike plate and vertical slots. 14 gauge lid of footlocker has a continuous hinge and also serves as a seat. Opening and closing of the lid is quieted by rubber bumpers mounted to the contact points. The seat lid is strengthened with two reinforcement channels welded to bottom. Lid/seat is supported by mounting side rails attached to the vertical posts. Optional coat rods using coat rod hooks mounted to shelf.

2.05 ACCESSORIES

(See Full Product Specifications)

2.06 FABRICATION

Fabricate lockers with fully framed construction, 8 male/female insertion points to provide the fully framed locker body, square, rigid, without warp, with metal faces flat and free of distortion. Fabricated on the unit principle, each locker with individual door and frame, individual top, bottom,

back and shelves. Verify dimensions and arrangement before fabrication.

Finish: Enamel powder coat paint finish electrostatically applied and properly cured to manufacturer's specifications for optimum performance. Finishes releasing VOC's and subject to out-gassing are not acceptable. Locker exterior and interior shall be painted the same color. Standard coating thickness is 1 to 1.2 mils (0.025 to 0.03 mm) dry film thickness minimum. Powder Coat Plus option is 2 to 2.2 mils (.05 to .055 mm). Colors as selected from manufacturer's standard colors.

Alternative finishes: Custom color match, Anti-Graffiti or Anti-Microbial finishes are available.

PART 3 - EXECUTION

3.01 EXAMINATION

Do not begin installation until substrates and bases have been properly prepared. If substrate and bases are the responsibility of another installer, notify Architect of unsatisfactory preparation before proceeding.

3.02 INSTALLATION

Install metal lockers and accessories at locations shown in accordance with manufacturer's instructions. Install lockers plumb, level, and square. Work is not to progress until site meets necessary conditions. Anchor lockers to floor and wall at intervals of 36 inches (0.914 m) or less, as recommended by manufacturer. Bolt adjoining locker units together to provide rigid installation. Install sloping tops and metal fillers using condealed fasteners. Provide flush hairline joints against adjacent surfaces. Install benches by fastening bench tops to pedestals and securely anchoring to the floor using appropriate anchors for the floor material.

3.03 ADJUSTING

Adjust doors and latches to operate without binding. Verify that latches are operating satisfactorily. Adjust built-in locks to prevent binding of dial or key and ensure smooth operation prior to substantial completion.

Touch-up with factory-supplied paint and repair or replace damaged products before substantial completion.

3.04 PROTECTION

Protect installed products until completion of project.

PATRIOT Fully Framed TA-50 Locker (Knocked Down)

PART 1 - GENERAL

1.01 SECTION INCLUDES

Heavy Duty Knocked Down TA-50 Lockers

1.02 REFERENCES

ADAAG - Americans with Disabilities Act, Accessibility Guidelines.

1.03 SUBMITTALS

Submit under provisions of Section 01 33 00. Shop Drawings: Show the following: Dimensioned drawings including plans, elevations, and sections to show locker locations and interfaces with adjacent substrates. Details of assembly, erection, anchorage and clearance requirements. Selection Samples: For each finish product specified, two complete sets of color chips representing manufacturer's full range of available colors and finishes.

1.04 DELIVERY, STORAGE AND HANDLING

Store products in manufacturer's unopened packaging until ready for installation to protect the locker finish and adjacent surfaces from damage.

PART 2 - PRODUCTS

2.01 MANUFACTURER

Acceptable Manufacturer: Penco Products, Inc., which is located at: 1820 Stonehenge Drive, Greenville, NC 27858; Tel: 800-562-1000; Fax: 800-248-1555; Email: general@pencoproducts.com; Web: www.pencoproducts.com .

Lockers shall be GREENGUARD Gold Certified by UL Environment through the GREENGUARD Certification Program.

2.02 MATERIALS

Steel: Prime grade mild cold-rolled sheet steel free from surface imperfection, capable of taking a high-grade enamel finish and in compliance with ASTM A1008. Sheet steel components shall be fabricated using zinc-coated steel free from surface imperfection, capable of taking a high-grade enamel finish and in compliance with ASTM A653. Flattened Expanded Metal Divisions that meets or exceeds ASTM A1008/A1008M, captured on all sides by the tubular shaped frame assembly. Self-Tapping Screws and Rivets. Provide only metal lockers that conform to Made in US regulations.

2.03 HEAVY DUTY PERSONAL TA-50 LOCKERS

Heavy Duty Lockers: All locker body components made of cold rolled steel specially formed for added strength and rigidity and to ensure tight joints at fastening points.

Locker Body Construction: Bottoms, Tops, and Shelves: 16-gauge steel. Sides: 16-gauge solid sides, Flattened expanded metal. Backs: Solid 18-gauge steel. One-piece. Doors: 14-gauge steel. Standard

Ventilation: 6-inch (152.4 mm) wide by 3/4" high (19.05 mm) high horizontal louvers arranged two groups of 6. Optional Ventilation: 3/4 inch (19 mm) wide by 1-1/2 inch (38 mm) high diamond-shaped perforations. Optional Ventilation: Solid. Tops and bottoms with four sides formed at 90 degrees welded to the fully- framed channel with cast corner pieces. Channel Base: 4-inch or 6-inch high. 14-gauge sheet forming a "C" channel attached to locker bottom. Shelves with four sides formed to 90 degrees, front and back edge having a second bend. Locker Body Construction: Tubular frame construction with cast steel interlocks provide a true fully framed locker body construction. Hole spacing in locker body construction: Not exceeding 3-inches. For factory assembly order Welded version.

Doors: One piece sheet steel with holes for attaching number plates.

Hinges: Continuous type: 16 gauge piano hinge measuring full height of door. Welded to door and attached to locker frame using steel rivets.

2.04 DOOR HANDLES AND LATCHING

Single Tier Lockers: Ultra Cremone Recessed Handle engages the door frame on three sides. The top and bottom frames are engaged with 0.375 inch (9.5 mm) steel rods, and a 0.25 x 0.36-inch-thick center latch engages at the side or left door. Locate handle in the formed stainless steel pocket. Double door configurations shall consist of a left hinged door secured its full length by the right hinged door when latched. Handle assembly shall be secured to the pocket using a guided channel. Pocket is secured to the door in two places. All door configurations delivered knocked down will have doors shipped separately for attachment on site using supplied hardware. Door shall be reinforced using a 20-gauge horizontal box pan MIG-welded a maximum of 8" on center to the hinge and latch side channels, and spot welded a maximum of 8" on center to the door skin along the upper and lower pan edge for optimum strength, quiet operation and stiffness. Firmly secure rubber silencers to locker frame.

ADA Compliant: Ultra Cremone Recessed Handle mechanism should be ADA complaint requiring no twisting, pinching or tight grasping and is operable using less than 5lbs of force.

2.05 INTERIOR EQUIPMENT

Heavy Duty TA-50 Lockers with Doors: Single Tier 78 inches (1981 mm): Shelf located approximately 13 inches (330 mm) below top of locker. Two heavy-duty single prong hooks with diameter of 0.276 inches mounted to shelf and will accept a coat rod. Two single prong hooks with a diameter of 0.187 inches in rear mounted to shelf.

2.06 ACCESSORIES

(See full product specifications.)

2.07 FABRICATION

Fabricate lockers with fully framed construction, 8 male/female tubular insertion points to provide the fully framed locker body, square, rigid, without warp, with metal faces flat and free of distortion. Fabricate lockers on the unit principle, each locker with individual door and frame, individual top, bottom, back, and shelves. Verify dimensions and arrangement before fabrication.

Finish: Enamel powder coat paint finish electrostatically applied and properly cured to manufacturer's specifications for optimum performance. Finishes containing volatile organic compounds and subject to out-gassing are not acceptable. Locker exterior and interior shall be painted the same color. Powder Coat - Dry Thickness: 1 to 1.2 mils (0.025 to 0.03 mm). Powder Coat Plus - Dry Thickness: 2 to 2.2 mils (0.05 to 0.055 mm). Color: As selected from manufacturer's standard colors.

Special Finishes: Custom color match, Anti-Graffiti, Anti-Microbial, and high performance finishes are available.

PART 3 - EXECUTION

3.01 EXAMINATION

Do not begin installation until substrates and bases have been properly prepared. If substrate and bases are the responsibility of another installer, notify Architect of unsatisfactory preparation before proceeding.

3.02 INSTALLATION

Install metal lockers and accessories at locations shown in accordance with manufacturer's instructions. Install lockers plumb, level, and square. Work is not to progress until site meets necessary conditions. Anchor lockers to floor and/or wall as recommended by the manufacturer. Bolt adjoining locker units together to provide rigid installation. Install sloping tops and metal fillers using concealed fasteners. Provide flush hairline joints against adjacent surfaces. Install benches by fastening bench tops to pedestals and securely anchoring to the floor using appropriate anchors for the floor material.

PATRIOT Fully Framed TA-50 Locker (Welded)

PART 1 - GENERAL

1.01 SECTION INCLUDES

Heavy Duty Welded TA-50 Lockers

1.02 REFERENCES

ADAAG - Americans with Disabilities Act, Accessibility Guidelines.

1.03 SUBMITTALS

Submit under provisions of Section 01 33 00. Shop Drawings shall show dimensioned plans, elevations, and sections.

1.04 DELIVERY, STORAGE AND HANDLING

Store products in manufacturer's unopened packaging until ready for installation to protect the locker finish and adjacent surfaces from damage.

PART 2 - PRODUCTS

2.01 MANUFACTURER

Acceptable Manufacturer: Penco Products, Inc., which is located at: 1820 Stonehenge Drive, Greenville, NC 27858; Tel: 800-562-1000; Fax: 800-248-1555; Email: general@pencoproducts.com; Web: www.pencoproducts.com

Lockers shall be GREENGUARD Gold Certified by UL Environment through the GREENGUARD Certification Program.

2.02 MATERIALS

Steel: Prime grade mild cold-rolled sheet steel free from surface imperfection, capable of taking a high-grade enamel finish and in compliance with ASTM A1008. Sheet steel components shall be fabricated using zinc-coated steel free from surface imperfection, capable of taking a high-grade enamel finish and in compliance with ASTM A653. Flattened Expanded Metal Divisions that meets or exceeds ASTM A1008/A1008M, captured on all sides by the tubular shaped frame assembly. Self-Tapping Screws and Rivets. Provide only metal lockers that conform to Made in US regulations.

2.03 HEAVY DUTY PERSONAL TA-50 LOCKERS

Heavy Duty Lockers: All locker body components made of cold rolled steel specially formed for added strength and rigidity and to ensure tight joints at fastening points.

Locker Body Construction: Bottoms, Tops, and Shelves: 16-gauge steel. Sides: 16-gauge solid sides, Flattened Expanded Metal. Backs: Solid 18-gauge steel. One-piece. Doors: 14-gauge steel. Standard Ventilation: 6-inch (152.4 mm) wide by 3/4" high (19.05 mm) high horizontal louvers arranged two groups of 6. Optional Ventilation: 3/4 inch (19 mm) wide by 1-1/2 inch (38 mm) high diamond-shaped perforations. Optional Ventilation: Solid tops and bottoms with four sides formed at 90 degrees welded to the fully-framed channel with cast corner pieces. Channel

Base: 4-inch or 6-inch high. 14-gauge sheet forming a "C" channel attached to locker bottom. Shelves with four sides formed to 90 degrees, front and back edge having a second bend. Locker Body Construction: Tubular frame construction with cast steel interlocks provide a true fully framed locker body construction. Hole spacing in locker body construction: Not exceeding 3 inches. For factory assembly order Welded version.

Locker Doors: One-piece sheet steel. Provide holes for attaching number plates.

Hinges: Continuous type: 16 gauge piano hinge measuring full height of door. Welded to door and attached to locker frame using steel rivets.

2.04 DOOR HANDLES AND LATCHING

Single Tier Lockers: Ultra Cremone Recessed Handle: Handle shall engage the door frame on three sides. The top and bottom frames are engaged with 0.375 inch (9.5 mm) steel rods, and a 0.25 x 0.36-inch-thick center latch engages at the side or left door. Locate handle in the formed stainless steel pocket. Double door configurations shall consist of a left hinged door secured its full length by the right hinged door when latched. Handle assembly shall be secured to the pocket using a guided channel. Pocket is secured to the door in two places. All door configurations delivered knocked down will have doors shipped separately for attachment on site using supplied hardware. Door shall be reinforced using a 20-gauge horizontal box pan MIG-welded a maximum of 8" on center to the hinge and latch side channels, and spot welded a maximum of 8" on center to the door skin along the upper and lower pan edge for optimum strength, quiet operation and stiffness. Firmly secure rubber silencers to locker frame.

ADA Compliant: Ultra Cremone Recessed Handle mechanism should be ADA complaint requiring no twisting,

pinching or tight grasping and is operable using less than 5lbs of force.

2.05 INTERIOR EQUIPMENT

A Heavy Duty TA-50 Lockers with Doors: Single-Tier, 78-inches (1981 mm): Shelf located approximately 13-inches (330 mm) below top of locker. Coat Rod - using two heavy-duty single prong hooks, mounted to shelf and two single prong hooks with a diameter of 0.187 in rear, mounted to shelf.

2.06 ACCESSORIES

(See full product specifications.)

2.07 FABRICATION

Fabricate lockers with fully framed construction, 8 male/female tubular insertion points to provide the fully framed locker body, square, rigid, without

warp, with metal faces flat and free of distortion. Fabricate lockers on the unit principle, each locker with individual door and frame, individual top, bottom, back, and shelves. Verify dimensions and arrangement before fabrication.

Finish: Enamel powder coat paint finish electrostatically applied and properly cured to manufacturer's specifications for optimum performance. Finishes containing volatile organic compounds and subject to out-gassing are not acceptable. Locker exterior and interior shall be painted the same color. Powder Coat - Dry Thickness: 1 to 1.2 mils (0.025 to 0.03 mm). Powder Coat Plus - Dry Thickness: 2 to 2.2 mils (0.05 to 0.055 mm). Color: As selected from manufacturer's standard colors.

Special Finishes: Custom color match, Anti-Graffiti, Anti-Microbial, and high performance finishes are available.

PART 3 - EXECUTION

3.01 EXAMINATION

Do not begin installation until substrates and bases have been properly prepared. If substrate and bases are the responsibility of another installer, notify Architect of unsatisfactory preparation before proceeding.

3.02 INSTALLATION

Install metal lockers and accessories at locations shown in accordance with manufacturer's instructions. Install lockers plumb, level, and square. Work is not to progress until site meets necessary conditions. Anchor lockers to floor and/or wall as recommended by the manufacturer. Bolt adjoining locker units together to provide rigid installation. Install sloping tops and metal fillers using concealed fasteners. Provide flush hairline joints against adjacent surfaces. Install benches by fastening bench tops to pedestals and securely anchoring to the floor using appropriate anchors for the floor material.

3.03 ADJUSTING

Adjust doors and latches to operate without binding. Verify that latches are operating satisfactorily. Adjust built-in locks to prevent binding of dial or key and ensure smooth operation prior to substantial completion.

Touch-up with factory-supplied paint and repair or replace damaged products before substantial completion.

3.04 PROTECTION

Protect installed products until completion of project.

PATRIOT[®] Fully Framed Gear Locker (Knocked Down)

PART 1 - GENERAL

1.01 SECTION INCLUDES

Heavy Duty Knocked Down Fully Framed Gear Lockers

1.02 REFERENCES

ADAAG - Americans with Disabilities Act, Accessibility Guidelines.

1.03 SUBMITTALS

Submit under provisions of Section 01 33 00. Shop Drawings: Show the following: Dimensioned drawings including plans, elevations, and sections to show locker locations and interfaces with adjacent substrates. Details of assembly, erection, anchorage and clearance requirements. Selection Samples: For each finish product specified, two complete sets of color chips representing manufacturer's full range of available colors and finishes.

1.04 DELIVERY, STORAGE AND HANDLING

Store products in manufacturer's unopened packaging until ready for installation to protect the locker finish and adjacent surfaces from damage.

PART 2 - PRODUCTS

2.01 MANUFACTURER

Acceptable Manufacturer: Penco Products, Inc., which is located at: 1820 Stonehenge Drive, Greenville, NC 27858; Tel: 800-562-1000; Fax: 800-248-1555; Email: general@pencoproducts.com; Web: www.pencoproducts.com

Lockers shall be GREENGUARD Gold Certified by UL Environment through the GREENGUARD Certification Program.

2.02 MATERIALS

Steel: All Penco standard lockers are constructed using prime grade steel free from surface imperfection capable of taking high grade enamel finish. Sheet steel components shall be zinc coated and free from surface imperfection and capable of taking high grade enamel finish. Flattened expanded metal divisions meet or exceed ASTM M1008/A1008M captured on all sides by the tubular shaped frame assembly. Self-tapping screws and rivets. Provide only metal lockers that conform to Made in US regulations.

2.03 HEAVY DUTY LOCKERS

Heavy Duty Lockers: All locker body components made of cold rolled steel specially formed for added strength and rigidity and to ensure tight joints at fastening points.

Locker Body Construction: Bottoms, Tops, and Shelves: 16-gauge steel. Sides: 16-gauge Solid Sides, Flattened expanded metal, 16-gauge Diamond Perforation on 72-inch high only. Backs: Solid 18-gauge steel. One-piece. Doors: 14-gauge steel. Standard Ventilation: 6-inch (152.4 mm) wide by ¾" high (19.05 mm) high horizontal louvers arranged two groups of 6. Optional Ventilation: ¾ inch (19 mm) wide by 1-1/2 inch (38 mm high diamond-shaped perforations. Optional Ventilation: Solid Tops and bottoms with four sides formed at 90 degrees welded to the fully- framed channel with cast corner pieces. Channel Base: 4-inch or 6-inch high. 14-gauge sheet forming a "C" channel attached to locker bottom. Shelves with four sides formed to 90 degrees, front and back edge having a second bend.

Tubular frame construction with cast steel interlocks provide a true fully framed locker body construction. Hole spacing in locker body construction: Not exceeding 3 inches.

Locker Doors: One-piece sheet steel. Provide holes for attaching number plates.

Hinges: Continuous type: 16-gauge piano hinge measuring full height of door. Welded to door and attached to locker frame using steel rivets.

2.04 DOOR HANDLES AND LATCHING

Single Tier Lockers: Ultra Cremone Recessed Handle: Handle shall engage the door frame on three sides. The top and bottom frames are engaged with 3/8 inch (9.5 mm) steel rods, and a ¼ x 3-inch-thick center latch engages at the side or left door. Locate handle in the formed stainless steel pocket. Double door configurations shall consist of a left hinged door secured its full length by the right hinged door when latched. Handle assembly shall be secured to the pocket using a guided channel. Pocket is secured to the door in two places. Doors 18" wide or wider shall be reinforced using a 20-gauge vertical pan spot welded at a maximum of 8" on center to the hinge side of the door.

Door shall be reinforced using a 20-gauge horizontal box pan spot-welded a maximum of 8" on center to the hinge and latch side channels, and spot welded a maximum of 8" on center to the door skin along

the upper and lower pan edge for optimum strength, quiet operation and stiffness. Firmly secure rubber silencers to locker frame.

PATRIOT® Fully Framed Gear Locker (Knocked Down)

ADA Compliant: Ultra Cremone Recessed Handle mechanism should be ADA complaint requiring no twisting, pinching or tight grasping and is operable using less than 5lbs of force.

2.05 INTERIOR EQUIPMENT

Heavy Duty Gear Lockers with Doors: Optional Full Width Shelf - located approximately 13-inches (330 mm) below top of locker. Optional Coat Rod - using two heavy duty single prong hooks, mounted to shelf and two single prong hooks with a diameter of 0.187 in rear, mounted to shelf.

2.06 ACCESSORIES

(See full product specifications.)

2.07 FABRICATION

Fabricate lockers with fully framed construction, 8 male/female tubular insertion points to provide the fully framed locker body, square, rigid, without warp, with metal faces flat and free of distortion. Fabricate lockers on the unit principle, each locker with individual door and frame, individual top, bottom, back, and shelves. Verify dimensions and arrangement before fabrication.

Finish: Enamel powder coat paint finish applied in strict adherence to paint manufacturer's specifications to provide optimum appearance and performance. Finishes releasing VOCs are not acceptable. Interior and Exterior shall be painted the same color. Standard coating thickness is 1 to 1.2 mil dry film thickness minimum. Powder Coat Plus option increases thickness to 2 to 2.2 mil minimum. Colors as selected from manufacturer's standard colors. All locker body components shall match color of door and frame.

Special Finishes: Custom color, Anti-Graffiti, and Anti-Microbial finishes are available.

PART 3 - EXECUTION

3.01 EXAMINATION

Do not begin installation until substrates and bases have been properly prepared. If substrate and

bases are the responsibility of another installer, notify Architect of unsatisfactory preparation before proceeding.

3.02 INSTALLATION

Install metal lockers and accessories at locations shown in accordance with manufacturer's instructions. Install lockers plumb, level, and square. Work is not to progress until site meets necessary conditions. Anchor lockers to floor and/or wall as recommended by the manufacturer. Bolt adjoining locker units together to provide rigid installation. Install sloping tops and metal fillers using concealed fasteners. Provide flush hairline joints against adjacent surfaces. Install benches by fastening bench tops to pedestals and securely anchoring to the floor using appropriate anchors for the floor material.

3.03 ADJUSTING AND CLEANING

Adjust doors and latches to operate without binding. Verify that latches are operating satisfactorily. Adjust built-in locks to prevent binding of dial or key and ensure smooth operation prior to substantial completion.

Touch-up with factory-supplied paint and repair or replace damaged products before substantial completion.

3.04 PROTECTION

Protect installed products until completion of project.

PATRIOT Fully Framed Gear Locker (Welded)

ADA Compliant: Ultra Cremona Recessed Handle mechanism should be ADA complaint requiring no twisting, pinching or tight grasping and is operable using less than 5lbs of force.

2.05 INTERIOR EQUIPMENT

Heavy Duty Gear Lockers with Doors: Optional Full Width Shelf - located approximately 13-inches (330 mm) below top of locker. Optional Coat Rod - using two heavy duty single prong hooks, mounted to shelf and two single prong hooks with a diameter of 0.187 in rear, mounted to shelf.

2.06 ACCESSORIES

(See full product specifications.)

2.07 FABRICATION

Fabricate lockers with fully framed construction, 8 male/female tubular insertion points to provide the fully framed locker body, square, rigid, without warp, with metal faces flat and free of distortion. Fabricate lockers on the unit principle, each locker with individual door and frame, individual top, bottom, back, and shelves. Verify dimensions and arrangement before fabrication.

Finish: Enamel powder coat paint finish applied in strict adherence to paint manufacturer's specifications to provide optimum appearance and performance. Finishes releasing VOCs are not acceptable. Interior and Exterior shall be painted the same color. Standard coating thickness is 1 to 1.2 mil dry film thickness minimum. Powder Coat Plus option increases thickness to 2 to 2.2 mil minimum. Colors as selected from manufacturer's standard colors. All locker body components shall match color of door and frame.

Special Finishes: Custom color , Anti-Graffiti, and Anti-Microbial finishes are available.

PART 3 - EXECUTION

3.01 EXAMINATION

Do not begin installation until substrates and bases have been properly prepared. If substrate and bases are the responsibility of another installer, notify Architect of unsatisfactory preparation before proceeding.

3.02 INSTALLATION

Install metal lockers and accessories at locations shown in accordance with manufacturer's instructions. Install lockers plumb, level, and square. Work is not to progress until site meets necessary conditions. Anchor lockers to floor and/or wall as recommended by the manufacturer. Bolt adjoining locker units together to provide rigid installation. Install sloping tops and metal fillers using concealed fasteners. Provide flush hairline joints against adjacent surfaces. Install benches by fastening bench tops to pedestals and securely anchoring to the floor using appropriate anchors for the floor material.

3.03 ADJUSTING AND CLEANING

Adjust doors and latches to operate without binding. Verify that latches are operating satisfactorily. Adjust built-in locks to prevent binding of dial or key and ensure smooth operation prior to substantial completion.

Touch-up with factory-supplied paint and repair or replace damaged products before substantial completion.

3.04 PROTECTION

Protect installed products until completion of project.

PATRIOT Fully Framed Gear Locker (Welded)

PART 1 - GENERAL

1.01 SECTION INCLUDES

Heavy Duty Welded Fully Framed Gear Lockers

1.02 REFERENCES

ADAAG - Americans with Disabilities Act, Accessibility Guidelines.

1.03 SUBMITTALS

Submit under provisions of Section 01 33 00. Shop Drawings: Show the following: Dimensioned drawings including plans, elevations, and sections to show locker locations and interfaces with adjacent substrates. Details of assembly, erection, anchorage and clearance requirements. Selection Samples: For each finish product specified, two complete sets of color chips representing manufacturer's full range of available colors and finishes.

1.04 DELIVERY, STORAGE AND HANDLING

Store products in manufacturer's unopened packaging until ready for installation to protect the locker finish and adjacent surfaces from damage.

PART 2 - PRODUCTS

2.01 MANUFACTURER

Acceptable Manufacturer: Penco Products, Inc., which is located at: 1820 Stonehenge Drive, Greenville, NC 27858; Tel: 800-562-1000; Fax: 800-248-1555; Email: general@pencoproducts.com; Web: www.pencoproducts.com

Lockers shall be GREENGUARD Gold Certified by UL Environment through the GREENGUARD Certification Program.

2.02 MATERIALS

Steel: All Penco standard lockers are constructed using prime grade steel free from surface imperfection capable of taking high grade enamel finish. Sheet steel components shall be zinc coated and free from surface imperfection and capable of taking high grade enamel finish. flattened expanded metal divisions meet or exceed ASTM M1008/A1008M captured on all sides by the tubular

shaped frame assembly. Self-tapping screws and rivets. Provide only metal lockers that conform to Made in US regulations.

2.03 HEAVY DUTY LOCKERS

Heavy Duty Lockers: All locker body components made of cold rolled steel specially formed for added strength and rigidity and to ensure tight joints at fastening points.

Locker Body Construction: Bottoms, Tops, and Shelves: 16-gauge steel. Sides: 16-gauge Solid Sides, Flattened expanded metal, 16-gauge Diamond Perforation on 72-inch high only. Backs: Solid 18-gauge steel. One-piece. Doors: 14-gauge steel. Standard Ventilation: 6-inch (152.4 mm) wide by 3/4" high (19.05 mm) high horizontal louvers arranged two groups of 6. Optional Ventilation: 3/4 inch (19 mm) wide by 1-1/2 inch (38 mm high diamond-shaped perforations. Optional Ventilation: Solid Tops and bottoms with four sides formed at 90 degrees welded to the fully- framed channel with cast corner pieces. Channel Base: 4-inch or 6-inch high. 14-gauge sheet forming a "C" channel attached to locker bottom. Shelves with four sides formed to 90 degrees, front and back edge having a second bend.

Welded shell. Tubular frame construction with cast steel interlocks provide a true fully framed locker body construction. Hole spacing in locker body construction: Not exceeding 3 inches.

Locker Doors: One-piece sheet steel. Provide holes for attaching number plates.

Hinges: Continuous type: 16-gauge piano hinge measuring full height of door. Welded to door and attached to locker frame using steel rivets.

2.04 DOOR HANDLES AND LATCHING

Single Tier Lockers: Ultra Cremone Recessed Handle: Handle shall engage the door frame on three sides. The top and bottom frames are engaged with 3/8 inch (9.5 mm) steel rods, and a

1/4 x 3-inch-thick center latch engages at the side or left door. Locate handle in the formed stainless steel pocket. Double door configurations shall consist of a left hinged door secured its full length by the right hinged door when latched. Handle assembly shall be secured to the pocket using a guided channel. Pocket is secured to the door in two places. Doors 18" wide or wider shall be reinforced using a 20-gauge vertical pan spot welded at a maximum of 8" on center to the hinge side of the door.

Door shall be reinforced using a 20-gauge horizontal box pan spot-welded a maximum of 8" on center to the hinge and latch side channels, and spot welded a maximum of 8" on center to the door skin along the upper and lower pan edge for optimum strength, quiet operation and stiffness. Firmly secure rubber silencers to locker frame.

PATRIOT® Fully Framed Turnout Locker (Knocked Down)

PART 1 - GENERAL

1.01 SECTION INCLUDES

Heavy Duty Knocked Down Fully Framed Turnout Open Front Lockers

1.02 REFERENCES

ADAAG - Americans with Disabilities Act, Accessibility Guidelines.

1.03 SUBMITTALS

Submit under provisions of Section 01 33 00. Shop Drawings shall show dimensioned plans, elevations, and sections. For each product specified, two complete sets of color chips representing manufacturer's full range of available colors and finishes.

1.04 DELIVERY, STORAGE AND HANDLING

Store products in manufacturer's unopened packaging until ready for installation to protect the locker finish and adjacent surfaces from damage.

PART 2 - PRODUCTS

2.01 MANUFACTURER

Acceptable Manufacturer: Penco Products, Inc., which is located at: 1820 Stonehenge Drive, Greenville, NC 27858; Tel: 800-562-1000; Fax: 800-248-1555; Email: general@pencoproducts.com; Web: www.pencoproducts.com

Lockers shall be GREENGUARD Gold Certified by UL Environment through the GREENGUARD Certification Program.

2.02 MATERIALS

Steel: Prime grade mild cold-rolled sheet steel free from surface imperfection, capable of taking a high-grade enamel finish and in compliance with ASTM A1008. Steel: Sheet steel components shall be fabricated using zinc-coated steel free from surface imperfection, capable of taking a high-grade enamel finish and in compliance with ASTM A653. Flattened Expanded Metal Divisions that meets or exceeds ASTM A1008/A1008M, captured on all sides by the tubular shaped frame assembly. Self-Tapping Screws and Rivets. Provide only metal lockers that conform to Made in US regulations.

2.03 HEAVY DUTY OPEN FRONT PERSONAL EQUIPMENT LOCKERS

Heavy Duty Lockers: All locker body components made of cold rolled steel specially formed for added strength and rigidity and to ensure tight joints at fastening points.

Locker Body Construction: Bottoms, Tops and Shelves made from 16-gauge steel. Sides shall be either 16-gauge solid, flattened expanded metal, or 16-gauge diamond perforation (on 72 inch high only). Backs shall be solid 18-gauge single piece. Tops and bottoms with four sides formed at 90 degrees welded to the fully-framed channel with cast corner pieces. Channel Base shall be 4 inch or 6 inch high form 14-gauge sheet forming "C" channel attached to locker bottom. Shelves with four sides formed to 90 degrees, front edge having a second bend. Tubular frame construction with cast steel interlocks to provide a true fully framed locker body construction. Hole spacing in body not to exceed 3 inches. Optional factory assembly of lockers (welded

version only).

2.04 INTERIOR EQUIPMENT

Heavy Duty Fully Framed Turnout Lockers Without Doors: Optional Full Width Shelf - located approximately 13-inches (330 mm) below top of locker. Optional Coat Rod - using two heavy duty single prong hooks, mounted to shelf and two single prong hooks with a diameter of 0.187 in rear, mounted to shelf.

2.05 ACCESSORIES

(For Full Line of Accessories see Complete Specifications Online)

Interior Equipment: Optional Acrylic Mirror: Self-Adhesive, 6-inch (152 mm) x 8 inch (203 mm). Optional Full Width Shelves: 16-gauge, flanged on four sides and attached securely to mounting side rails. Optional Center Partition: 16-gauge with flanged front. Attaches securely to shelf and locker bottom or additional lower shelf. (Not for use with footlocker or seat) Mounting holes for half shelves provided on nominal 6 inch centers.

4. Optional Half Shelf: 16-gauge, used with full height center partition only. Flanged on three sides. Optional "L" Shaped Half Shelves: 16-gauge, flanged on three sides and attached securely on one side with a side rail, and flanged partition mounted to shelf or half shelf above. Optional Security box: 16-gauge lockable door with a 16-gauge side panel. The door is attached to the welded frame of the security using a two-point hinge. The door is locked through a single point latch with a padlock or built-in lock. A door pull shall be provided for use with padlocks. Security box door frame to be not less than 16 gauge formed to a channel shape. Vertical members to have an additional flange to provide a continuous door strike. 9-inch wide, 12-inch wide, 15-inch wide, 18-inch wide, 21-inch wide, 24-inch wide. Optional cell phone/key tray: 8-inch (203 mm) x 2-inch (51 mm) x 2-inch (51 mm) mounted to flanged partition side of the half shelf. Optional metal seat only: 14-gauge, mounted using mounting rails to vertical corner posts allowing adjustability. Optional hardwood seat only: 1-1/4" thick full depth mounted using mounting rails to vertical corner posts allowing adjustability. Optional footlocker: Recessed from locker frame to clear full length locker door. Front foot locker panel includes single point latch with padlock strike plate and vertical slots. 14-gauge lid of footlocker has a continuous hinge and. Also serves as a seat. Opening and closing of the lid is quieted by rubber bumpers mounted to the contact points. The seat lid is strengthened with reinforcement channels welded to bottom. Lid/seat is supported by two mounting side rails attached to the vertical posts. Optional sheet steel document sleeve. 16-gauge measuring 12-inches wide (horizontal storage) or 9-1/2 inches wide (vertical storage) mounted to flanged partition side of the half shelf. Optional Drawers. 12-inch-high or 6-inch high. Drawer body shall be constructed of 16-gauge sheet steel, mounted using an integral "C" channel

and mounted to the side rails that are mounted to the corner posts. Optional Parachute/body armor rack. Formed from 3/4 inch diameter, heavy wall steel tube. Reinforced by 14-gauge gussets. Mounted to rear of locker using two mounting rails between corner posts. 180-pound capacity. Optional Inner Compartment Door, attached to "L" shaped half shelf. Optional Coat Rods using coat rod hooks mounted to shelf.

2.06 FABRICATION

Fabricate lockers with fully framed construction, 8 male/female tubular insertion points to provide the fully framed locker body, square, rigid, without warp, with metal faces flat and free of distortion. Fabricate lockers on the unit principle, each locker with individual door and frame, individual top, bottom, back, and shelves. Verify dimensions and arrangement before fabrication.

Finish: Enamel powder coat paint finish electrostatically applied and properly cured to manufacturer's specifications for optimum performance. Finishes releasing VOC's and subject to out-gassing are not acceptable. Locker exterior and interior shall be painted the same color. Standard coating thickness is 1 to 1.2 mils (0.025 to 0.03 mm) dry film thickness minimum. Powder Coat Plus option is 2 to 2.2 mils (.05 to .055 mm). Colors as selected from manufacturer's standard colors.

Alternative finishes: Custom color match, Anti-Graffiti or Anti-Microbial finishes are available.

PART 3 - EXECUTION

3.01 EXAMINATION

Do not begin installation until substrates and bases have been properly prepared. If substrate and bases are the responsibility of another installer, notify Architect of unsatisfactory preparation before proceeding.

3.02 INSTALLATION

Install metal lockers and accessories at locations shown in accordance with manufacturer's instructions. Install lockers plumb, level, and square. Work is not to progress until site meets necessary conditions. Anchor lockers to floor and/or wall as recommended by the manufacturer. Bolt adjoining locker units together to provide rigid installation. Install sloping tops and metal fillers using concealed fasteners. Provide flush hairline joints against adjacent surfaces. Install benches by fastening bench tops to pedestals and securely anchoring to the floor using appropriate anchors for the floor material.

3.03 ADJUSTING

Adjust doors and latches to operate without binding. Verify that latches are operating satisfactorily. Adjust built-in locks to prevent binding of dial or key and ensure smooth operation prior to substantial completion. Touch-up with factory-supplied paint and repair or replace damaged products before substantial completion.

3.04 PROTECTION

Protect installed products until completion of project.

PATRIOT® Fully Framed Turnout Locker (Welded)

PART 1 - GENERAL

1.01 SECTION INCLUDES

Heavy Duty Welded Fully Framed Turnout Open Front Lockers

1.02 REFERENCES

ADAAG - Americans with Disabilities Act, Accessibility Guidelines.

1.03 SUBMITTALS

Submit under provisions of Section 01 33 00. Shop Drawings shall show dimensioned plans, elevations, and sections. For each product specified, two complete sets of color chips representing manufacturer's full range of available colors and finishes.

1.04 DELIVERY, STORAGE AND HANDLING

Store products in manufacturer's unopened packaging until ready for installation to protect the locker finish and adjacent surfaces from damage.

PART 2 - PRODUCTS

2.01 MANUFACTURER

Acceptable Manufacturer: Penco Products, Inc., which is located at: 1820 Stonehenge Drive, Greenville, NC 27858; Tel: 800-562-1000; Fax: 800-248-1555; Email: general@pencoproducts.com; Web: www.pencoproducts.com. Lockers shall be GREENGUARD Gold Certified by UL Environment through the GREENGUARD Certification Program.

2.02 MATERIALS

Steel: Prime grade mild cold-rolled sheet steel free from surface imperfection, capable of taking a high-grade enamel finish and in compliance with ASTM A1008. Steel: Sheet steel components shall be fabricated using zinc-coated steel free from surface imperfection, capable of taking a high-grade enamel finish and in compliance with ASTM A653. Flattened Expanded Metal Divisions that meets or exceeds ASTM A1008/A1008M, captured on all sides by the tubular shaped frame assembly. Self-Tapping Screws and Rivets. Provide only metal lockers that conform to Made in US regulations.

2.03 HEAVY DUTY OPEN FRONT PERSONAL EQUIPMENT LOCKERS

Heavy Duty Lockers: All locker body components made of cold rolled steel specially formed for added strength and rigidity and to ensure tight joints at fastening points.

Locker Body Construction: Bottoms, Tops and Shelves made form 16-gauge steel. Sides shall be either 16-gauge solid, Flattened Expanded Metal, or 16-gauge diamond perforation (on 72 inch high only). Backs shall be solid 18-gauge single piece. Tops and bottoms with four sides formed at 90 degrees welded to the fully-framed channel with cast corner pieces. Channel Base shall be 4 inch or 6 inch high form 14-gauge sheet forming "C" channel attached to locker bottom. Shelves with four sides formed to 90 degrees, front edge having a second bend. Tubular frame construction with cast steel interlocks to provide a true fully framed locker body construction. Hole spacing in body not to exceed 3 inches. Optional factory assembly of lockers (welded

version only).

2.04 INTERIOR EQUIPMENT

Heavy Duty Fully Framed Turnout Lockers Without Doors: Optional Full Width Shelf - located approximately 13-inches (330 mm) below top of locker. Optional Coat Rod - using two heavy duty single prong hooks, mounted to shelf and two single prong hooks with a diameter of 0.187 in rear, mounted to shelf.

2.05 ACCESSORIES

(For Full Line of Accessories see Complete Specifications Online)

Interior Equipment: OptioOptional Acrylic Mirror: Self-Adhesive, 6-inch (152 mm) x 8 inch (203 mm). Optional Full Width Shelves: 16-gauge, flanged on four sides and attached securely to mounting side rails. Optional Center Partition: 16-gauge with flanged front. Attaches securely to shelf and locker bottom or additional lower shelf. (Not for use with footlocker or seat) Mounting holes for half shelves provided on nominal 6 inch centers.

4. Optional Half Shelf: 16-gauge, used with full height center partition only. Flanged on three sides. Optional "L" Shaped Half Shelves: 16-gauge, flanged on three sides and attached securely on one side with a side rail, and flanged partition mounted to shelf or half shelf above. Optional Security box: 16-gauge lockable door with a 16-gauge side panel. The door is attached to the welded frame of the security using a two-point hinge. The door is locked through a single point latch with a padlock or built-in lock. A door pull shall be provided for use with padlocks. Security box door frame to be not less than 16 gauge formed to a channel shape. Vertical members to have an additional flange to provide a continuous door strike. 9-inch wide, 12-inch wide, 15-inch wide, 18-inch wide, 21-inch wide, 24-inch wide. Optional cell phone/key tray: 8-inch (203 mm) x 2-inch (51 mm) x 2-inch (51 mm) mounted to flanged partition side of the half shelf. Optional metal seat only: 14-gauge, mounted using mounting rails to vertical corner posts allowing adjustability. Optional hardwood seat only: 1-1/4" thick full depth mounted using mounting rails to vertical corner posts allowing adjustability. Optional footlocker: Recessed from locker frame to clear full length locker door. Front foot locker panel includes single point latch with padlock strike plate and vertical slots. 14-gauge lid of footlocker has a continuous hinge and. Also serves as a seat. Opening and closing of the lid is quieted by rubber bumpers mounted to the contact points. The seat lid is strengthened with reinforcement channels welded to bottom. Lid/seat is supported by two mounting side rails attached to the vertical posts. Optional sheet steel document sleeve. 16-gauge measuring 12-inches wide (horizontal storage) or 9-1/2 inches wide (vertical storage) mounted to flanged partition side of the half shelf. Optional Drawers. 12-inch-high or 6-inch high. Drawer body shall be constructed of 16-gauge sheet

steel, mounted using an integral "C" channel and mounted to the side rails that are mounted to the corner posts. Optional Parachute/body armor rack. Formed from 3/4 inch diameter, heavy wall steel tube. Reinforced by 14-gauge gussets. Mounted to rear of locker using two mounting rails between corner posts. 180-pound capacity. Optional Inner Compartment Door, attached to "L" shaped half shelf. Optional Coat Rods using coat rod hooks mounted to shelf.

2.06 FABRICATION

Fabricate lockers with fully framed construction, 8 male/female tubular insertion points to provide the fully framed locker body, square, rigid, without warp, with metal faces flat and free of distortion.

Fabricate lockers on the unit principle, each locker with individual door and frame, individual top, bottom, back, and shelves. Verify dimensions and arrangement before fabrication.

Finish: Enamel powder coat paint finish electrostatically applied and properly cured to manufacturer's specifications for optimum performance. Finishes releasing VOC's and subject to out-gassing are not acceptable. Locker exterior and interior shall be painted the same color. Standard coating thickness is 1 to 1.2 mils (0.025 to 0.03 mm) dry film thickness minimum. Powder Coat Plus option is 2 to 2.2 mils (.05 to .055 mm). Colors as selected from manufacturer's standard colors.

Alternative finishes: Custom color match, Anti-Graffiti or Anti-Microbial finishes are available.

PART 3 - EXECUTION

3.01 EXAMINATION

Do not begin installation until substrates and bases have been properly prepared. If substrate and bases are the responsibility of another installer, notify Architect of unsatisfactory preparation before proceeding.

3.02 INSTALLATION

Install metal lockers and accessories at locations shown in accordance with manufacturer's instructions. Install lockers plumb, level, and square. Work is not to progress until site meets necessary conditions. Anchor lockers to floor and/or wall as recommended by the manufacturer. Bolt adjoining locker units together to provide rigid installation. Install sloping tops and metal fillers using concealed fasteners. Provide flush hairline joints against adjacent surfaces. Install benches by fastening bench tops to pedestals and securely anchoring to the floor using appropriate anchors for the floor material.

3.03 ADJUSTING

Adjust doors and latches to operate without binding. Verify that latches are operating satisfactorily. Adjust built-in locks to prevent binding of dial or key and ensure smooth operation prior to substantial completion. Touch-up with factory-supplied paint and repair or replace damaged products before substantial completion.

3.04 PROTECTION

Protect installed products until completion of project.

PATRIOT® Fully Framed Duty Locker (Knocked Down)

PART 1 - GENERAL

1.01 SECTION INCLUDES

Heavy Duty Knocked Down Fully Framed Duty Lockers

1.02 REFERENCES

ADAAG - Americans with Disabilities Act, Accessibility Guidelines.

1.03 SUBMITTALS

Submit under provisions of Section 01 33 00. Shop Drawings shall show dimensioned plans, elevations, sections, details of assembly, erection anchorage and clearance requirements. For each product specified, two complete sets of color chips representing manufacturer's full range of colors for selection are available.

1.04 DELIVERY, STORAGE AND HANDLING

Store products in manufacturer's unopened packaging until ready for installation to protect the locker finish and adjacent surfaces from damage.

PART 2 - PRODUCTS

2.01 MANUFACTURER

Acceptable Manufacturer: Penco Products, Inc., which is located at: 1820 Stonehenge Drive, Greenville, NC 27858; Tel: 800-562-1000; Fax: 800-248-1555; Email: general@pencoproducts.com; Web: www.pencoproducts.com.

Lockers shall be GREENGUARD Gold Certified by UL Environment through the GREENGUARD Certification Program.

2.02 MATERIALS

Steel: All Penco standard lockers are constructed using prime grade steel free from surface imperfection capable of taking high grade enamel finish. Sheet steel components shall be zinc coated and free from surface imperfection and capable of taking high grade enamel finish. Self-tapping screws and rivets. Provide only metal lockers that conform to Made in US regulations.

2.03 HEAVY DUTY LOCKERS

Heavy Duty Lockers: All locker body components made of cold rolled steel specially formed for added strength and rigidity and to ensure tight joints at fastening points.

Locker Body: Bottoms, Tops, and Shelves: 16-gauge steel. Sides: 16-gauge solid sides Backs: Solid 18-gauge steel. One-piece. Doors: 14-gauge steel. Standard Ventilation: 6-inch (152.4 mm) wide by ¾" high (19.05 mm) high horizontal louvers arranged two groups of 6. Optional Ventilation: 3/4 inch (19 mm) wide by 1-1/2 inch (38 mm) high diamond-shaped perforations. Optional Ventilation: Solid tops and bottoms with four sides formed at 90 degrees welded to the fully- framed channel with cast corner pieces. Shelves with four sides formed to 90 degrees, front and back edge having a second bend. Locker Body Construction: Tubular frame construction with cast steel interlocks provide a true fully framed locker body construction. Hole spacing in locker body construction: Not exceeding 3 inches. Optional factory assembly of lockers (welded version only).

Locker Doors: One piece sheet steel. Provide holes for number plates.

Hinges: Continuous type 16 gauge hinge measuring full height of door. Welded to door and attached to locker frame using steel rivets.

Duty Locker Drawer Base with Integral Seat: 78-inch-high Duty lockers provide a 78-inches high locker with a 9-inch or 12-inch front extension to create the drawer base. 90-inch-high Duty lockers, provide a 90-inches high locker with a 9-inch or 12-inch front extension to create the drawer base. 16-gauge drawer body, rated at 250 pounds per pair. Drawer face with integral finger grab and punched to accept built-in spring bolt locker lock, key lock or padlock. Hardwood seat: Laminated selected hardwood, 1-1/4 inch (31.75 mm) full finished thickness, corners rounded and sanded, surfaces finished with two coats of clear lacquer. Depth: 9-1/2 inches (241.3 mm) or 12-inches (304.8 mm) depending on front extension size. Length: As shown, continuous along adjoining lockers with drawer bases or individual benches for each unit.

2.04 DOOR HANDLES AND LATCHING

Single Tier Lockers: Ultra Cremone Recessed Handle: Handle shall be a die cast lift handle that engages the door

frame on three sides. The top and bottom frames are engaged with 3/8 inch (9.5 mm) steel rods, and a ¼ x 3-inch-thick center latch engages at the side or left door. Locate handle in the formed stainless steel pocket. Double door configurations shall consist of a left hinged door secured its full length by the right hinged door when latched. Handle assembly shall be secured to the pocket using a guided channel. Pocket is secured to the door in two places. Doors 18" wide or wider shall be reinforced using a 20-gauge vertical pan spot welded at a maximum of 8" on center to the hinge side of the door. Door shall be reinforced using a 20-gauge horizontal box pan spot-welded a maximum of 8" on center to the hinge and latch side channels, and spot welded a maximum of 8" on center to the door skin along the upper and lower pan edge for optimum strength, quiet operation and stiffness. Firmly secure rubber silencers to locker frame.

PATRIOT® Fully Framed Duty Locker (Knocked Down)

ADA Compliant: Ultra Cremone Recessed Handle mechanism shall be ADA complaint requiring no twisting, pinching or tight grasping and is operable using less than 5lbs of force.

2.05 INTERIOR EQUIPMENT **Heavy Duty Lockers With Doors:**

Optional Full Width Shelf - located approximately 13-inches (330 mm) below top of locker.
Optional Coat Rod - using two heavy duty single prong hooks, mounted to shelf and two single prong hooks with a diameter of 0.187 in rear, mounted to shelf.

06 ACCESSORIES

(See full product specifications.)

2.07 FABRICATION

Fabricate lockers with fully framed construction, 8 male/female tubular insertion points to provide the fully framed locker body, square, rigid, without warp, with metal faces flat and free of distortion. Fabricate lockers on the unit principle, each locker with individual door and frame, individual top, bottom, back, and shelves. Verify dimensions and arrangement before fabrication.

Finish: Enamel powder coat paint finish electrostatically applied and properly cured to manufacturer's specifications for optimum performance. Finishes containing volatile organic compounds and subject to out-gassing are not acceptable. Locker exterior and interior shall be painted the same color.

Alternative finishes: Custom color, Anti- Graffiti, and Anti-Microbial finishes are available.

PART 3 - EXECUTION

3.01 EXAMINATION

Do not begin installation until substrates and bases have been

properly prepared. If substrate and bases are the responsibility of another installer, notify Architect of unsatisfactory preparation before proceeding.

3.02 INSTALLATION

Install metal lockers and accessories at locations shown in accordance with manufacturer's instructions. Install lockers plumb, level, and square. Work is not to progress until site meets necessary conditions. Anchor lockers to floor and/or wall as recommended by the manufacturer. Bolt adjoining locker units together to provide rigid installation. Install sloping tops and metal fillers using concealed fasteners. Provide flush hairline joints against adjacent surfaces. Install benches by fastening bench tops to pedestals and securely anchoring to the floor using appropriate anchors for the floor material.

3.03 ADJUSTING AND CLEANING

Adjust doors and latches to operate without binding. Verify that latches are operating satisfactorily. Adjust built-in locks to prevent binding of dial or key and ensure smooth operation prior to substantial completion. Touch-up with factory-supplied paint and repair or replace damaged products before substantial completion.

3.04 PROTECTION

Protect installed products until completion of project.

PATRIOT Fully Framed Duty Locker (Welded)

PART 1 – GENERAL

1.01 SECTION INCLUDES

Heavy Duty Welded Fully Framed Duty Lockers

1.02 REFERENCES

ADAAG - Americans with Disabilities Act, Accessibility Guidelines.

1.03 SUBMITTALS

Submit under provisions of Section 01 33 00. Shop Drawings shall show dimensioned plans, elevations, sections, details of assembly, erection anchorage and clearance requirements. For each product specified, two complete sets of color chips representing manufacturer's full range of colors for selection are available.

1.04 DELIVERY, STORAGE AND HANDLING

Store products in manufacturer's unopened packaging until ready for installation to protect the locker finish and adjacent surfaces from damage.

PART 2 – PRODUCTS

2.01 MANUFACTURER

Acceptable Manufacturer is Penco Products, Inc. located at 1820 Stonehenge Dr., Greenville, NC 27858.

Lockers shall be GREENGUARD Gold Certified by UL Environment through the GREENGUARD Certification Program.

2.02 MATERIALS

Steel: All Prime grade mild cold-rolled sheet steel free from surface imperfection, capable of taking a high-grade enamel finish and in compliance with ASTM A1008. Sheet steel components shall be fabricated using zinc-coated steel free from surface imperfection, capable of taking a high-grade enamel finish and in compliance with ASTM A653. Self-Tapping Screws and Rivets. Provide only metal lockers that conform to Made in US regulations.

2.03 HEAVY-DUTY PERSONAL DUTY LOCKERS

Heavy Duty Lockers: All locker body components made of cold rolled steel specially formed for added strength and rigidity and to ensure tight joints at fastening points.

Locker Body Construction: Welded shell. Bottoms, Tops, and Shelves: 16-gauge steel. Sides: 16-gauge solid sides. Backs: Solid 18-gauge steel. One-piece. Doors: 14-gauge steel. Standard Ventilation: 6-inch (152.4 mm) wide by 3/4" high (19.05 mm) high horizontal louvers arranged two groups of 6. Optional Ventilation: 3/4 inch (19 mm) wide by 1-1/2 inch (38 mm) high diamond-shaped perforations. Optional Ventilation: Solid tops and bottoms with four sides formed at 90 degrees welded to the fully- framed channel with cast corner pieces. Shelves with four sides formed to 90 degrees, front and back edge having a second bend. Locker Body Construction: Welded shell. Tubular frame construction with cast steel interlocks provide a true fully framed locker body construction. Hole spacing in locker body construction: Not exceeding 3 inches.

Locker Doors: One piece sheet steel. Provide holes for number plates.

Hinges: Continuous type: 16 gauge hinge measuring full height of door. Welded to door and attached to locker frame using steel rivets.

Duty Locker Drawer Base with Integral Seat:

78-inch high Duty lockers, provide a 78-inch high locker with a 9-inch or 12-inch front extension to create the drawer base. 90-inch high Duty lockers, provide a 90-inch high locker with a 9-inch or 12-inch front extension to create the drawer base. 16-gauge drawer body, rated at 250 pounds per pair. Drawer face with integral finger grab and punched to accept built-in spring bolt locker lock, key lock or padlock. Hardwood seat: Laminated selected hardwood, 1-1/4 inch (31.75 mm) full finished thickness, corners rounded and sanded, surfaces finished with two coats of clear lacquer. Depth: 9-1/2 inches (241.3 mm) or 12-inches (304.8 mm) depending on front extension size. Length: As shown, continuous along adjoining lockers with drawer bases or individual benches for each unit.

2.04 DOOR HANDLES AND LATCHING

Single Tier Lockers: Ultra Cremone Recessed Handle: Handle shall be a die cast lift handle that engages the door frame on three sides. The top and bottom frames are engaged with 3/8 inch (9.5 mm) steel rods, and a 1/4 x

3-inch-thick center latch engages at the side or left door. Locate handle in the formed stainless steel pocket. Double door configurations shall consist of a left hinged door secured its full length by the right hinged door when latched. Handle assembly shall be secured to the pocket using a guided channel. Pocket is secured to the door in two places. Doors 18" wide or wider shall be reinforced using a 20-gauge vertical pan spot welded at a maximum of 8" on center to the hinge side of the door. Door shall be reinforced using a 20-gauge horizontal box pan spot-welded a maximum of 8" on center to the hinge and latch side channels, and spot welded a maximum of 8" on center to the door skin along the upper and lower pan edge for optimum strength, quiet operation and stiffness. Firmly secure rubber silencers to locker frame.

PATRIOT® Fully Framed Duty Locker (Welded)

ADA Compliant: Ultra Cremona Recessed Handle mechanism shall be ADA complaint requiring no twisting, pinching or tight grasping and is operable using less than 5lbs of force.

2.05 INTERIOR EQUIPMENT **Heavy Duty Duty Lockers with Doors:**

Optional Full Width Shelf - located approximately 13-inches (330 mm) below top of locker.
Optional Coat Rod – using two heavy duty single prong hooks, mounted to shelf and two single prong hooks with a diameter of 0.187 in rear, mounted to shelf.

2.06 ACCESSORIES (See full product specifications.)

2.07 FABRICATION

Fabricate lockers with fully framed construction, 8 male/female tubular insertion points to provide the fully framed locker body, square, rigid, without warp, with metal faces flat and free of distortion. Fabricate lockers on the unit principle, each locker with individual door and frame, individual top, bottom, back, and shelves. Verify dimensions and arrangement before fabrication.

Finish: Enamel powder coat paint finish electrostatically applied and properly cured to manufacturer's specifications for optimum performance. Finishes containing volatile organic compounds and subject to out-gassing are not acceptable. Locker exterior and interior shall be painted the same color. Powder Coat - Dry Thickness: 1 to 1.2 mils (0.025 to 0.03 mm). Powder Coat Plus - Dry Thickness: 2 to 2.2 mils (0.05 to 0.055 mm). Color: As selected from manufacturer's standard colors.

Special Finishes: Custom color , Anti-Graffiti, and Anti-Microbial finishes are available.

PART 3 - EXECUTION

3.01 EXAMINATION

Do not begin installation until substrates and bases have been properly prepared. If substrate

and bases are the responsibility of another installer, notify Architect of unsatisfactory preparation before proceeding.

3.02 INSTALLATION

Install metal lockers and accessories at locations shown in accordance with manufacturer's instructions. Install lockers plumb, level, and square. Work is not to progress until site meets necessary conditions. Anchor lockers to floor and/or wall as recommended by the manufacturer. Bolt adjoining locker units together to provide rigid installation. Install sloping tops and metal fillers using concealed fasteners. Provide flush hairline joints against adjacent surfaces. Install benches by fastening bench tops to pedestals and securely anchoring to the floor using appropriate anchors for the floor material.

3.03 ADJUSTING AND CLEANING

Adjust doors and latches to operate without binding. Verify that latches are operating satisfactorily. Adjust built-in locks to prevent binding of dial or key and ensure smooth operation prior to substantial completion.

Touch-up with factory-supplied paint and repair or replace damaged products before substantial completion.

3.04 PROTECTION

Protect installed products until completion of project.

PATRIOT® Fully Framed Lockers Accessories

PART 1 – GENERAL

1.01 SECTION INCLUDES Accessories for Metal Lockers

1.02 REFERENCES

ADAAG - Americans with Disabilities Act, Accessibility Guidelines.

1.03 SUBMITTALS

Submit under provisions of Section 01 33 00. Shop Drawings shall show dimensioned plans, elevations, and sections.

1.04 DELIVERY, STORAGE AND HANDLING

Store products in manufacturer's unopened packaging until ready for installation to protect the locker finish and adjacent surfaces from damage.

PART 2 – PRODUCTS

2.01 MANUFACTURER

Penco Products, Inc. or approved equal based upon ability to provide product compliant with specifications of the product selected. Provide only metal lockers that conform to Made in US regulations.

Lockers shall be GREENGUARD Gold Certified by UL Environment through the GREENGUARD Certification Program.

2.02 MATERIALS

Steel: All Penco standard accessories are constructed using prime grade mild cold-rolled sheet steel free from surface imperfection meeting ASTM A1008 and capable of taking a high-grade enamel powder coat finish. Alternate material: Sheet steel components shall be fabricated using zinc-coated steel meeting ASTM A653 and finished in the same manner.

2.03 ACCESSORIES

Number Plates: Provide each locker with a polished aluminum number plate, 2-1/4 inches (57 mm) wide by 1 inch (25 mm) high, with black numerals not less than 3/8 inch (9.5 mm) high; attach to face of door on lockers and face of shelf on Turnout and Stadium, with two aluminum rivets.

Locks: Built-in flat key locks; master-key to same series. Built-in grooved key locks (pin tumbler); master-key to same series. Built-in three-number dialing combination locks capable of at least five different combination changes; provide master key, combination change key and combination control chart. Padlocks: master-keyed three-number dialing combination type padlocks; provide master key.

Channel Base: 4-inch high. 14-gauge sheet forming a "C" channel attached to locker bottom. 6-inch high. 14-gauge sheet forming a "C" channel attached to locker bottom.

Name Card Holder: Plated steel. Holds 1.25" (31.75 mm) x 2.75" card (69.85 mm).

Center Partition: 16-gauge with flanged front. Attaches securely to shelf and locker bottom or additional lower shelf. (Not for use with footlocker or seat) Mounting holes for side shelves provided on nominal 6 inch centers.

Side Shelf: 16-gauge, used with center partition only. Flanged on three sides.

Acrylic mirror: Self adhesive, 6-inch (152.4 mm) x 8 inch (203.2 mm).

Hooks: Used for Coat Rod. Two heavy-duty single prong hooks with a diameter of 0.276 mounted to shelf and designed to accept a coat rod.

Coat Rod, Full Length: Using coat rod hooks mounted to shelf: 18-inch (used with 18-inch wide locker only); 24-inch (used with 24-inch wide locker only); 30-inch (used with 30-inch wide lockers only); 36-inch (used with 36-inch wide lockers only); 42-inch (used with 42-inch wide lockers only); 48-inch (used with 48-inch wide lockers only)

Coat Rod, Half Length: Using coat rod hooks mounted to shelf: 9-inch (used with 18-inch locker with center partition or half shelves); 12-inch (used with 24-inch locker with center partition or half shelves); 15-inch

(used with 30-inch locker with center partition or half shelves); 36-inch (actually 18-inch long and used with 36-inch locker with center partition or half shelves); 42-inch (actually 21-inch long and used with 42-inch locker with center partition or half shelves); 48-inch (actually 24-inch long and used with 48-inch locker with center partition or half shelves)

Hooks: Single prong hooks with a diameter of 0.187 in rear, mounted to shelf.

Garment Separator: Full width. Use as an alternative to the optional Coat Rod accessory. Attaches to shelf.

Full width shelves: 16-gauge, flanged on all four sides, formed to 90 degrees, front and back edge having a second bend, attached securely to mounting side rails. Optional Back Rails are available for additional shelf support when needed.

Back Rails: 16 gauge, Optional, one per shelf, used with Full Width Shelves when extra support is needed.

Half Shelves: "L" Shaped Half Shelves: 16-gauge, flanged on three sides and attached securely on one side with a side rail, and flanged partition mounted to shelf or half shelf above.

Security Box, 12 inch: 18-gauge lockable door with a 18-gauge side panel. The door is attached to a welded frame with a two-point hinge. The door is locked through a single point latch with a padlock or built-in lock. A door pull shall be provided for use with padlocks. Security box door frame to be not less than 16-gauge formed to a channel shape. Vertical members to have an additional flange to provide a continuous door strike. Widths: 9-inch, 12-inch, 15-inch, 18-inch, 21-inch, 24-inch.

Security Box Panels: Used with security box unit when ordering a flattened expanded metal division and a Security Box together, this panel is used in the inside of compartment to block the view from the outside.

PATRIOT® Fully Framed Lockers Accessories

Inner Compartment Door: Attached to "L" shaped half shelf. 18 gauge.

Inner Compartment Panels: Used with inner compartment door unit, when ordering a flattened expanded metal division and an inner compartment door together, this panel is used in the inside of compartment to block the view from the outside.

Cell Phone/Key Tray: 8-inch (203.2 mm) x 2-inch (50.8 mm) x 2-inch (50.8 mm) mounted to flanged partition side of the half shelf or center partition.

Boot Tray: Aluminum, measuring 14 x 12.

Metal Seat only: 14 gauge, mounted using mounting rails to vertical corner posts allowing adjustability.

Hardwood Bench Seat only: 1-1/4" thick full depth, mounted using mounting rails to vertical corner posts allowing adjustability.

Individual Hardwood Seat for Duty Lockers: 1-1/4" full finished thickness depth, Corners rounded and sanded, exposed surfaces finished with two coats of clear lacquer.

Footlocker: Recessed from locker frame to clear full-length locker door. Front footlocker panel includes single point latch with padlock strike plate and vertical slots. 14-gauge lid of footlocker has a continuous hinge and serves as a seat. Rubber bumpers mounted to the contact points quiet opening and closing of the lid. Two reinforcement channels welded to bottom strengthens seat lid. Two mounting side rails attached to the vertical posts support lid/seat.

Document Sleeve Small: 16 gauge measuring 9.5-inch x 3-inch x 8-inch

Document Sleeve Large: 16 gauge measuring 12-inch x 3-inch x 8-inch

Drawer Base Unit for Duty Lockers: 78-inch-high Duty lockers provide a 78-inches high locker with a 9-inch or 12-inch front extension to create the

drawer base. 90-inch-high Duty lockers provide a 90-inches high locker with a 9-inch or 12-inch front extension to create the drawer base, 16-gauge drawer body, rated at 250 pounds per pair. Drawer face with integral finger grab and punched to accept built-in spring bolt locker lock, key lock or padlock.

Bottom Drawers: 12-inch high. Drawer body shall be constructed of 16-gauge sheet steel, mounted using an integral "C" channel and mounted to the side rails that are mounted to the corner posts.

Intermediate Drawers: 6-inch high. Drawer body shall be constructed of 16-gauge sheet steel, mounted using an integral "C" channel and mounted to the side rails that are mounted to the corner posts.

Parachute/Body Armor Rack: Formed from 3/4-inch diameter, heavy wall steel tube. Reinforced by 14-gauge gussets. Mounted securely to rear of locker using two mounting rails between corner posts. 180-pound capacity

Heavy-Duty Bench Pedestals: Steel tubing with 11-gauge steel flanges welded to each end, 16-1/4 inches (412 mm) high, finish to match lockers.

Stainless Steel Free-Standing Bench Pedestals: 2-inch (50 mm) diameter brushed 16-gauge stainless steel formed into a trapezoid, 14-inch (355 mm) wide bottom with two 5/16 inch (7.9 mm) diameter holes, top flange with four 5/16 inch (7.9 mm) diameter holes for fastening to bench.

shown in accordance with manufacturer's instructions. Install sloping tops and metal fillers using concealed fasteners. Provide flush hairline joints against adjacent surfaces. Install benches by fastening bench tops to pedestals and securely anchoring to the floor using appropriate anchors for the floor material.

3.03 ADJUSTING

Adjust built-in locks to prevent binding of dial or key and ensure smooth operation prior to substantial completion.

Touch-up with factory-supplied paint and repair or replace damaged products before substantial completion.

3.04 PROTECTION

Protect installed products until completion of project.

PART 3 - EXECUTION

3.01 EXAMINATION

Do not begin installation until substrates and bases have been properly prepared. If substrate and bases are the responsibility of another installer, notify Architect of unsatisfactory preparation before proceeding.

3.02 INSTALLATION

Install metal accessories at locations

Americans with Disabilities Act Information (ADA)

Penco lockers commonly accepted for ADA or barrier-free assignments are single tier and double-tier (lower tier only) when equipped with the Classic III recessed handle with multi-point latching: Vanguard, Guardian, Invincible II, Welded Gen2 and Angle Iron (with available modifications). Other handle types and certain lock selections may not be recognized as ADA compliant without modification.

Single tier 60" or 72" high lockers with the Classic III recessed multi-point latch handles must have shelves relocated and/or added to accommodate ADAAG mandated reach ranges. Two tier 36" high openings with the Classic III recessed handle may be used by designating the lower tier for ADA compliance. An extra shelf should be ordered to bring the lowest reach point within the prescribed ADAAG range based upon side or forward reach. Field drilling for these shelf locations on smaller requirements is recommended. The owner or architect may



also require a handicapped access sign be placed on the door.

Other handles and configurations may be specified, but these are the most appropriate based upon a literal interpretation. Attention should also be paid to the clear area

in front of the lockers to meet other separate but related guidelines. Contact your Penco Representative for assistance or go to www.access-board.gov to view the ADA Accessibility guidelines in full.



GREENGUARD

All products manufactured by Penco Products are GREENGUARD Gold Certified through UL Environment's GREENGUARD Certification Program. This certification signifies that Penco's products are now in compliance with the stringent chemical emissions guidelines set by UL Environment. Accredited courses are available to design professionals and fulfill credit requirements for AIA, GBCI, IDCEC. Contact a Penco Sales Manager for more information.



ADA locker can optionally be marked with a decal.



ADA locker has shelf at least 15 inches from floor.

Environmental Information

- Based upon the most recent information from our source mills, the recycled content of our steel lockers can range from 25% to over 50%. Because the percentage of recycled content may vary from project to project based on a number of variables, please contact our offices for detailed information on your specific requirement.
- Powder coating drastically reduces waste through high efficiency application & recovery methods.
- Penco's powder coat paint contains no solvents and as a result releases no Volatile Organic Compounds (VOC's) normally associated with wet paint processes.
- Our packaging contains at least 20% post-consumer recycled content.
- Approximately 34% of the U.S. population lives within a 500 mile radius of our manufacturing facility, requiring less fuel to ship our products to many destinations.





NOTE: Colors shown are as close to actual finishes as the printing process allows. Do not make your final color selection based on the color shade shown on this page. Penco Color Charts are available for a more accurate color match. Exposure to high humidity, chlorine salts, abrasive cleaners, germicidal cleaners and acids can damage the finish and will void the guarantee. For outdoor applications or other harsh environmental conditions, contact your Penco representative.

Standard Colors

To assure rust resistance and paint adhesion, all Penco steel products receive a state of the art pre-paint conditioning that includes a thorough cleansing by a hot spray washing process, then a specially formulated coating is applied creating a surface that resists corrosion and improves paint adhesion. All lockers are available in the 24 colors shown above.

Standard Powder Coat Finish

Penco's standard 1 mil thick paint finish is perfect for most applications. The paint surface is tough and durable and offers a beautiful drip-free surface, excellent edge coverage and environmentally friendly application.

PowderCoatPlus™

PowderCoatPlus is an optional cost-effective way of improving the durability and rust resistance. After a specialized cleaning and pre-treatment of the steel, a 2 mil thick coating of powder coat enamel is applied and baked onto the steel surface.

Antimicrobial Paint

Antimicrobial Paint finishes offer an added level of protection against virus and disease-causing micro-organisms while increasing resistance to stain and odor-causing bacteria, yielding an easier-to-clean product with extended durability and aesthetic appeal.

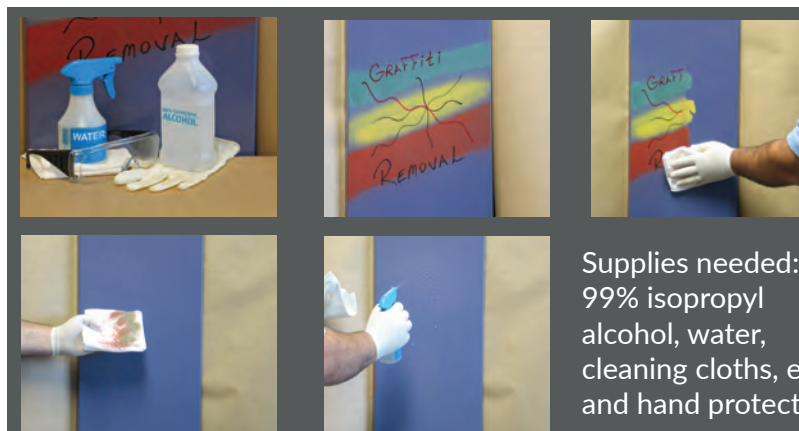

X-Off™ Anti-Graffiti Paint

Penco's optional X-Off Anti-Graffiti Paint for lockers provides a surface coating that allows easy removal of graffiti with alcohol and water. This specially formulated paint has a tight molecular structure that completely seals the locker surface, preventing graffiti and corrosive agents from penetrating the finish.

Supplies needed:
99% isopropyl alcohol, water, cleaning cloths, eye and hand protection.

Garment Dispensers

Penco Products builds upon 50 years of experience in the design, fabrication and sales support of garment lockers through its acquisition of Steiner Systems, an industry trailblazer and leader. This experience, combined with Penco's long history of providing a full range of storage solutions, achieves an unmatched level of expertise to ensure a superior product and high level of customer support.

Our wide spectrum of professional garment distribution lockers includes hanging garment dispensers, folded garment dispensers, laundry lockups and towel and linen control centers. These robust products are designed and built to provide the end user with many years of uninterrupted service.

- Individual locker provides each user with a locked compartment for personal belongings including uniforms, equipment, supplies or tools
- Simultaneous access to all lockers by management is available through the master door
- All hardware is zinc plated and assembly rivets are rust-proof aluminum
- All Hanging Garment Lockers can be personalized with your company's logo. Ask your sales representative for more details.



4 Compartment

6 Compartment

8 Compartment

Big 8 Compartment

Sales Managers - Hygiene and Textile Rental Products

Sales Manager	Areas Served	Phone
Bob Brett, Northeast Regional Manager	CT, DC, DE, MA, MD, ME, NH, NJ, NY, OH, PA, RI, VT	215-375-2935
Tony Taylor, Southeast Regional Manager	AL, AR, FL, GA, KY, LA, MS, NC, TN, SC, VA, WV	770-331-0451
Mike Rochon, Central Regional Manager	IL, IN, IA, MI, MN, NE, ND, KS, MO, OK, SD, TX, WI	815-566-1691
Randy Polen, Western Regional Manager	AK, AZ, CA, CO, HI, ID, MT, NM, NV, OR, US, WA, WY	805-490-1551
Yves L'Esperance, Canada Regional Manager	CANADA	514-594-2354

Hanging Garment Dispensers

Description	Garment Gray Part #	Silver Vein Part #	Lock Type	Overall Dimensions	Compartment Dimensions	Door Dimensions	Wt. (lbs.)	Height
4 Compartment "2 Over 2"	LF-2/2-GRY-CAM	LF-2/2-SLV-CAM	Cam	23-15/16"W	11-1/2"W	9-1/4"W 35-9/16"H	158	Standard Height 80-13/16"
	LF-2/2-GRY-TRNB	LF-2/2-SLV-TRNB	Turn Knob	21-7/16"D	21-7/16"D			
	LF-2/2-GRY-COM	LF-2/2-SLV-COM	Combo	80-13/16"H	35-11/16"H			
6 Compartment	LF-6C-GRY-CAM	LF-6C-SLV-CAM	Cam	23-15/16"W	7-10/16"W	6-5/16"W 35-9/16"H	158	Heights With Accessories With Base: 85"
	LF-6C-GRY-TRNB	LF-6C-SLV-TRNB	Turn Knob	21-7/16"D	21-7/16"D			
	LF-6C-GRY-COM	LF-6C-SLV-COM	Combo	80-13/16"H	35-11/16"H			
8 Compartment	LF-8C-GRY-CAM	LF-8C-SLV-CAM	Cam	23-15/16"W	5-3/4"W	4-3/4"W 35-9/16"H	158	With Slope Top: 87"
	LF-8C-GRY-TRNB	LF-8C-SLV-TRNB	Turn Knob	21-7/16"D	21-7/16"D			
	LF-8C-GRY-COM	LF-8C-SLV-COM	Combo	80-13/16"H	35-11/16"H			
Big 8 Compartment	LF-BG8-GRY-CAM	LF-BG8-SLV-CAM	Cam	30-19/32"W	7-1/2"W	6-5/16"W 35-9/16"H	163	With Base & Slope Top: 91"
	LF-BG8-GRY-TRNB	LF-BG8-SLV-TRNB	Turn Knob	21-7/16"D	21-7/16"D			
	LF-BG8-GRY-COM	LF-BG8-SLV-COM	Combo	80-13/16"H	35-11/16"H			

Garment Dispensers

Folded Garment Dispensers & Laundry Lockups



9 Compartment

10 Compartment

16 Compartment

Laundry Lockups					
Description	Garment Gray Part #	Silver Vein Part #	Laundry Lockup Dimensions	Swing Door Dimensions	Wt. (lbs.)
Maxi Laundry Lockup	LF-LDM-GRY	LF-LDM-SLV	23-15/16"W 21-7/16"D 80-13/16"H	21-11/16"W 12-1/2"H	105
Standard Laundry Lockup	LF-LDS-GRY	LF-LDS-SLV	16-1/4"W 21-7/16"D 80-13/16"H	13-3/4"W 12-1/2"H	78
Mini Laundry Lockup	10200-GRAY	10200-SLVN	16-1/2"W 16"D 39-1/4"H	11"W 8-3/4"H	35

Laundry Lockups

- Choose from three sizes: mini, standard and maxi Laundry Lockups
- Holds between 35 and 140 plus pounds of soiled products
- Provides security of soiled merchandise
- Prevents theft and misuse of secured merchandise
- Reduces fire and sanitation hazards

Folded Garment Dispensers

Description	Garment Gray Part #	Silver Vein Part #	Lock Type	Overall Dimensions	Door Dimensions	Wt. (lbs.)
9 Compartment	13100-GRAY	N/A	Cam	24"W 16"D 80"H	19-1/2"W 8"H	122
	13700-GRAY	N/A	Turn Knob			
10 Compartment	12100-GRAY	N/A	Cam	16-1/2"W 16"D 77-1/2"H	12"W 7"H	100
	12700-GRAY	N/A	Turn Knob			
	N/A	12200-SLVN	Padlock Attachment			
16 Compartment	11100-GRAY	N/A	Cam	16-1/2"W 16"D 77-1/2"H	12"W 4-1/2"H	111
	11700-GRAY	N/A	Turn Knob			

Folded Garment Dispensers

- Individual locker gives the user their own locked compartment for personal belongings including uniforms, equipment, supplies, or tools
- Simultaneous access to all lockers by management is available through the master door
- Simply turn one key and open all locker compartments at once
- Penco folded garment lockers are furnished with standard cam locks or turn knobs

Locks & Knobs



Cam Lock with 2 keys



Master Keyed Combination Lock



Turn Knob (padlock not included)

Optional Accessories

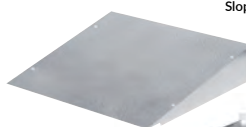

Slope Top



Closed Base

Open Base



Maxi Laundry Lockup

Standard Laundry Lockup

Mini Laundry Lockup



Garment Gray



Silver Vein

Choice of two powder coated colors on most models.



The parent company of Penco Products and its affiliates is Industrial Manufacturing Company (IMC). IMC and its international arm, IMCI, are a proud family of companies that produce a wide variety of innovative products for industry.

With more than 3,500 direct employees and over 34 worldwide manufacturing, sales and distribution facilities, we provide tier-one products and services to some of the most demanding industries imaginable.

This vast diversity of global resources and networking infrastructure allows us to utilize the strengths of each company, learn from each other and create a technological advantage within each industry. Common to every associate in our family

of companies, is the profound respect for and the integrity of established industrial principles and practical openness to applications of new technology. With individual company histories spanning decades, and in two cases, more than a century, the IMC and IMCI companies are time-tested leaders in their national and global markets.



INDUSTRIAL MANUFACTURING COMPANY INTERNATIONAL

www.mfgco.com

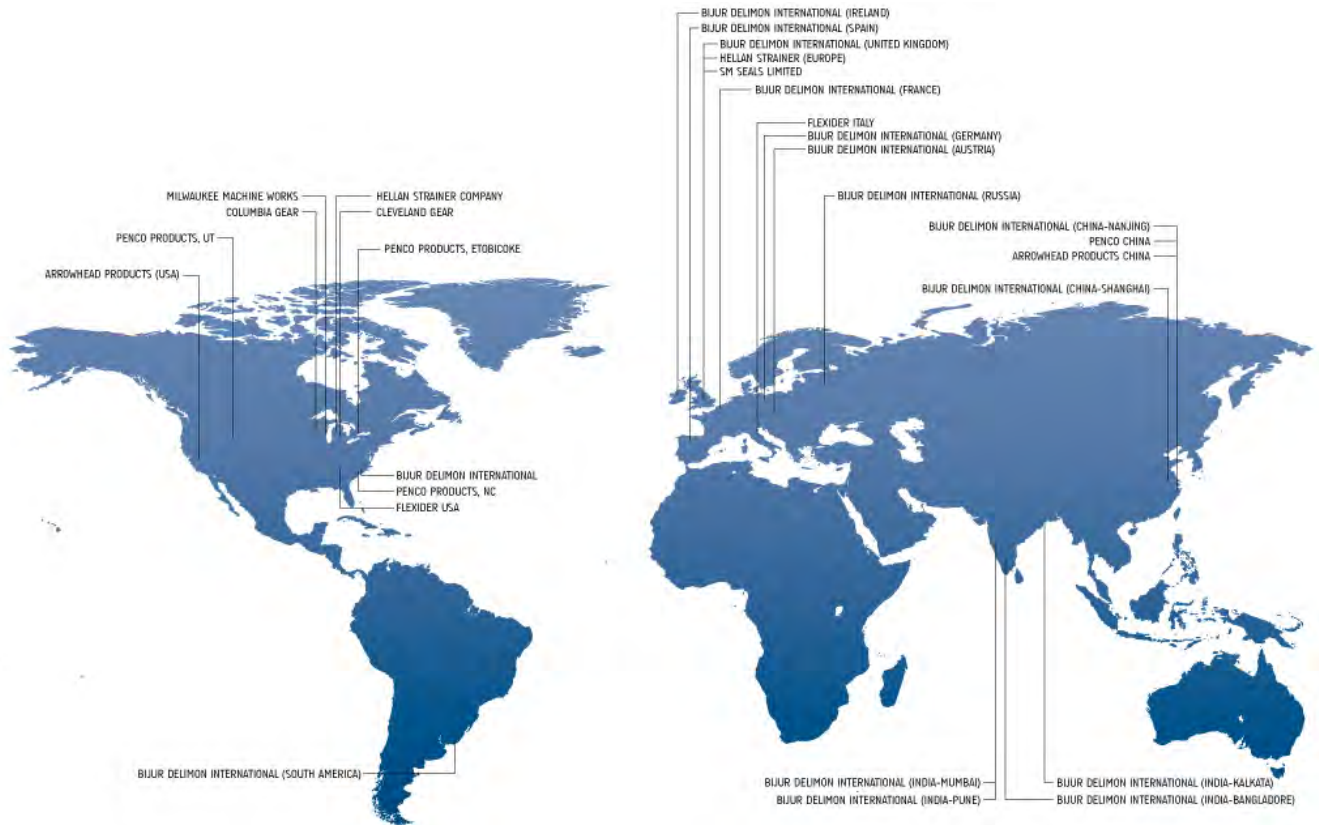

STEEL LOCKERS

STEEL INDUSTRIAL SHELVING

HYGIENE PRODUCTS

@PENCOPRODUCTS



WWW.PENCOPRODUCTS.COM

PENCO PRODUCTS, INC. | 1820 Stonehenge Drive, Greenville, NC 27858
Phone: 800-562-1000 | Fax: 800-248-1555 | general@pencoproducts.com

© Copyright 2021 Penco Products, Inc.

STORAGECATALOG SEPTEMBER_22_2022